

MIR DENTAL

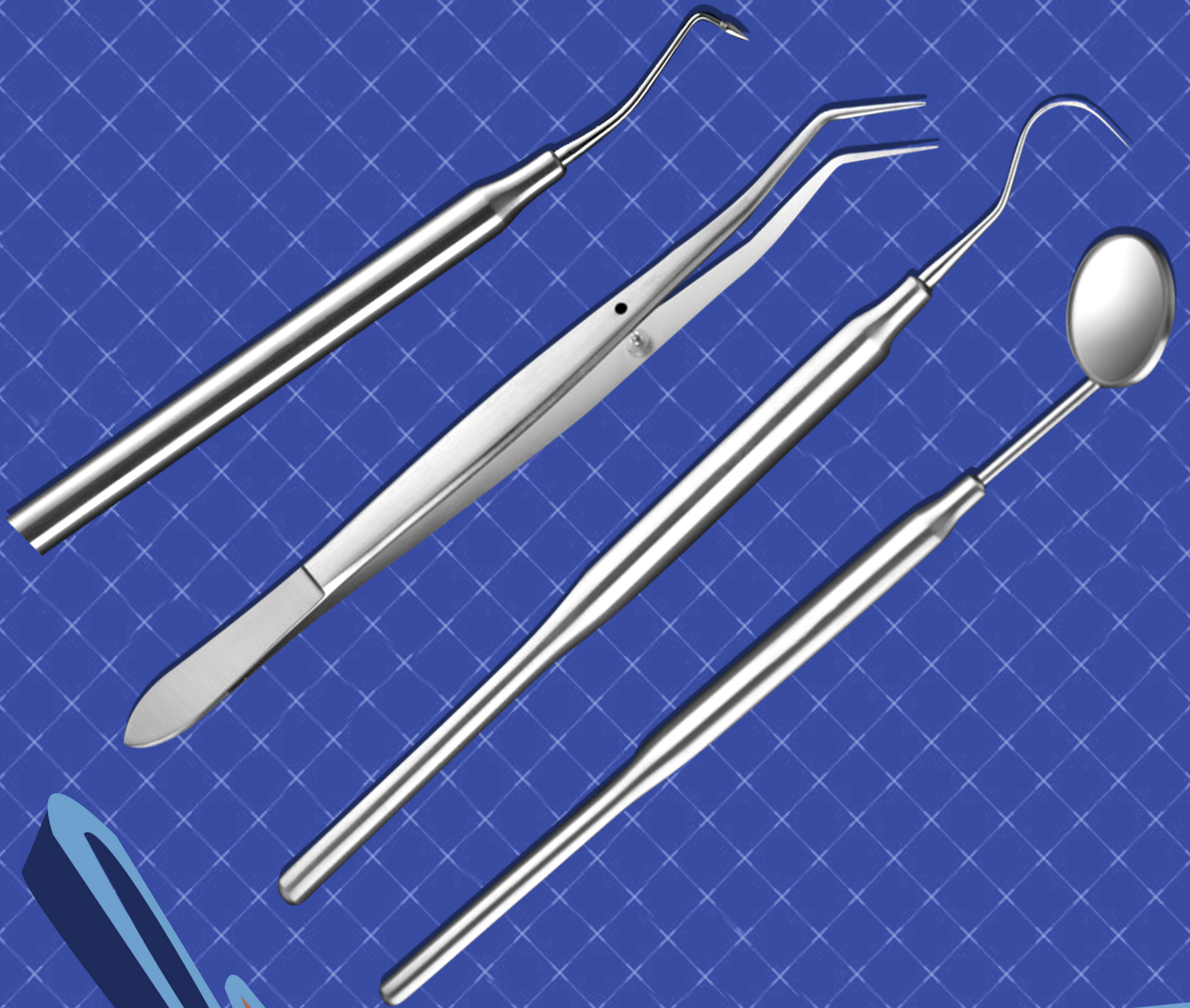



Extracting Forceps - English Pattern



1001
Fig 8
lower premolars



1002
Fig 13
lower premolars

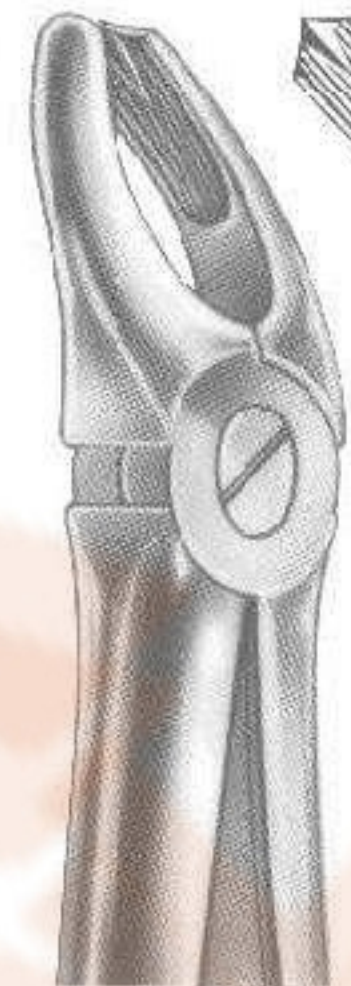
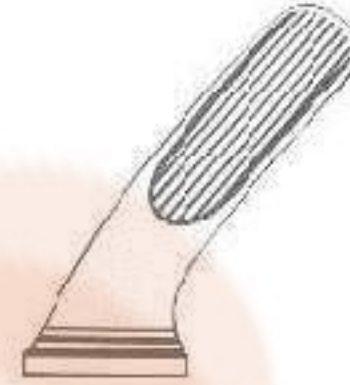

1003
Fig 17
upper molars, right

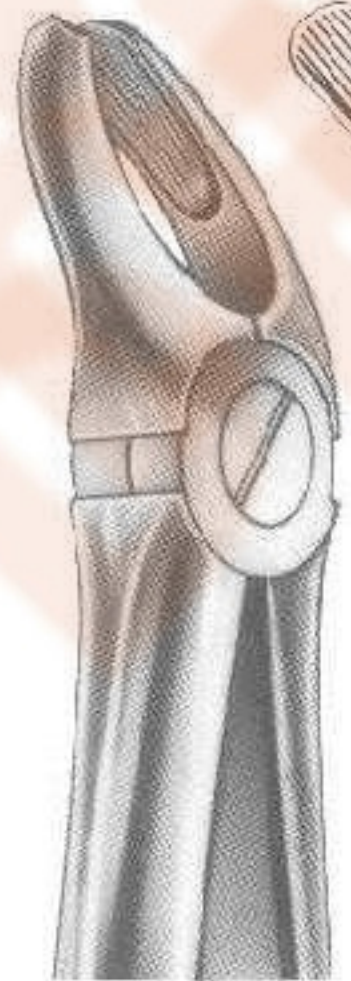
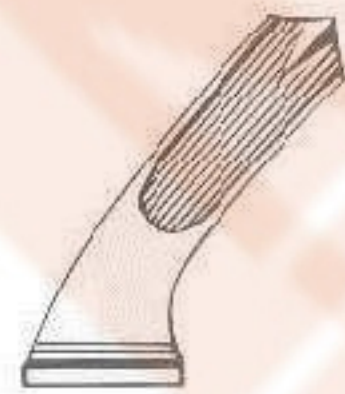
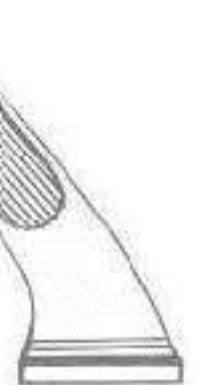

1004
Fig 18
upper molars, left



1005
Fig 18 A
upper molars

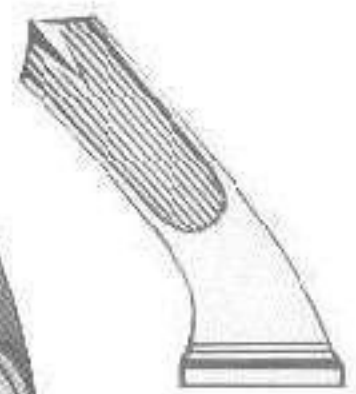

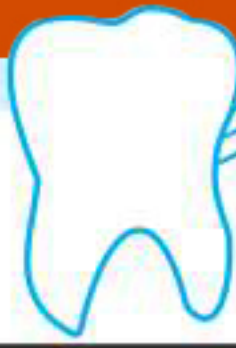

Extracting Forceps - English Pattern

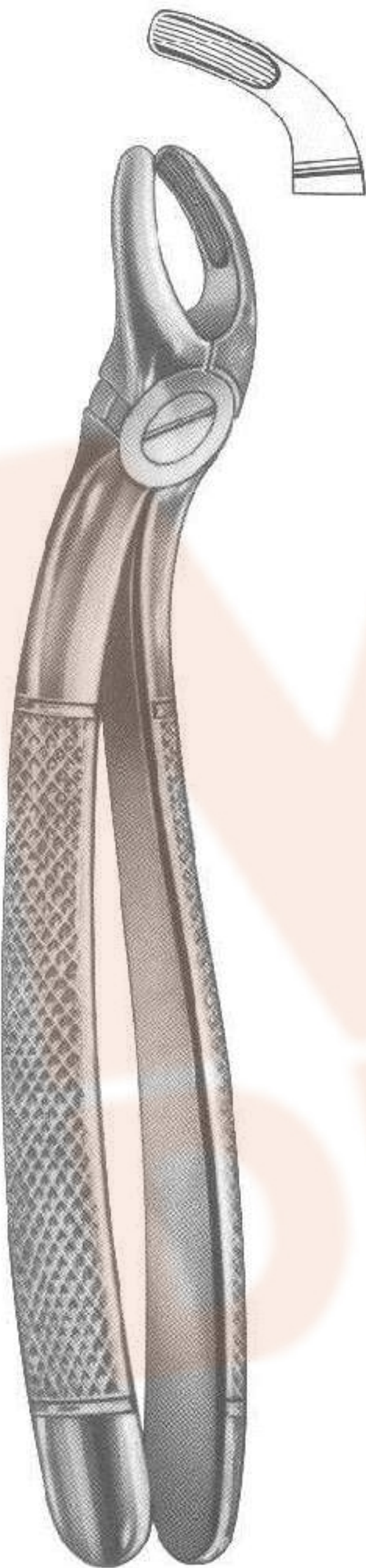

1006
Fig 19
upper wisdoms

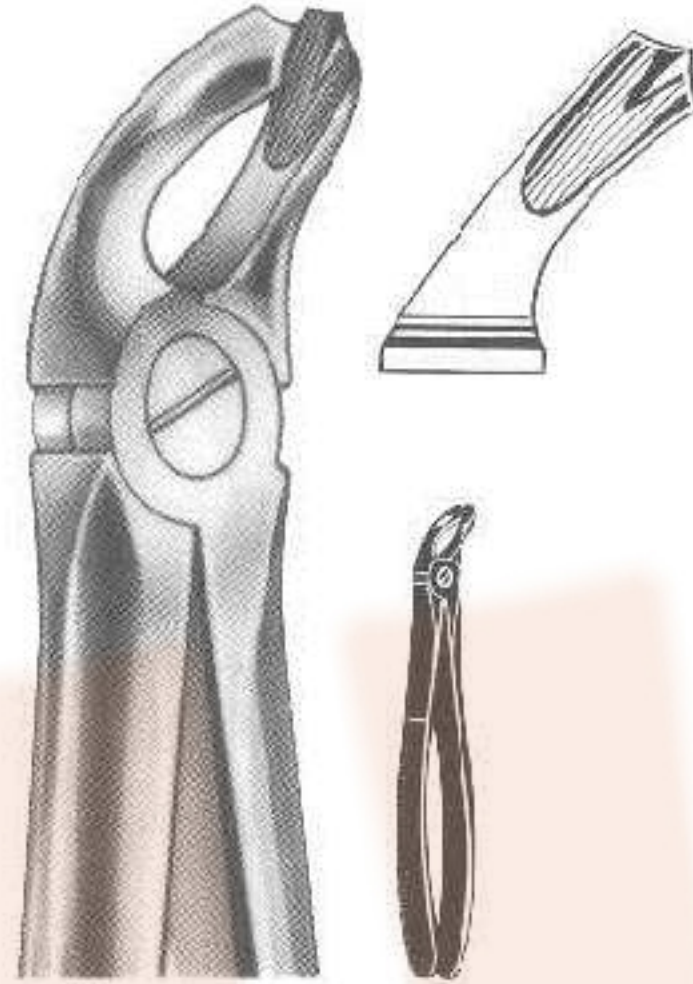

1007
Fig 20
lower wisdoms

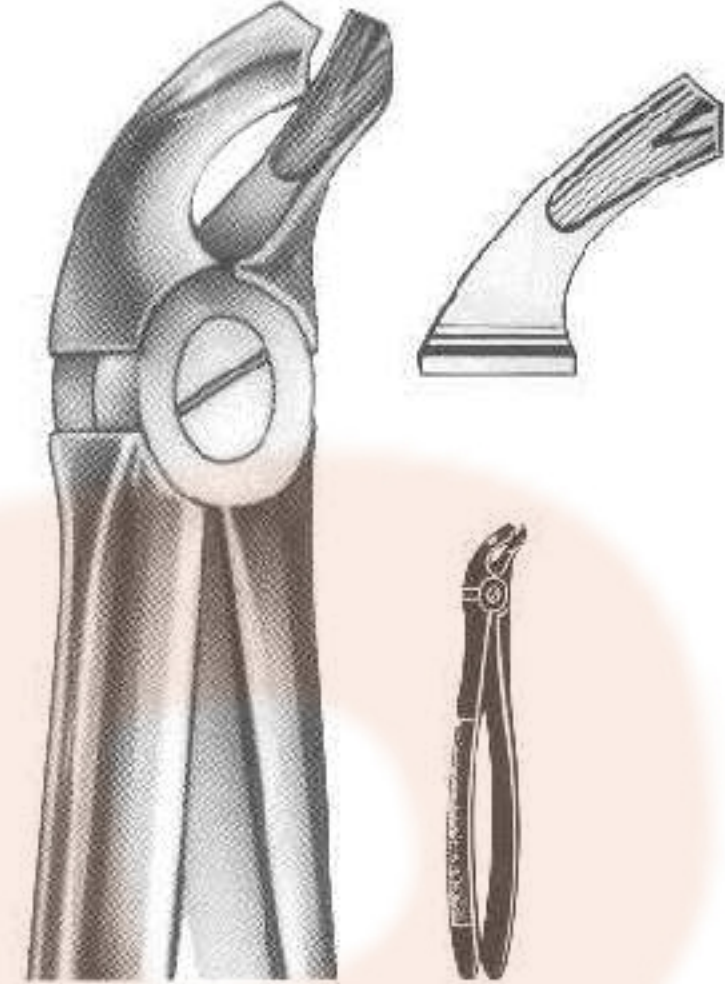

1008
Fig 21
lower molars



1009
Fig 22
lower molars

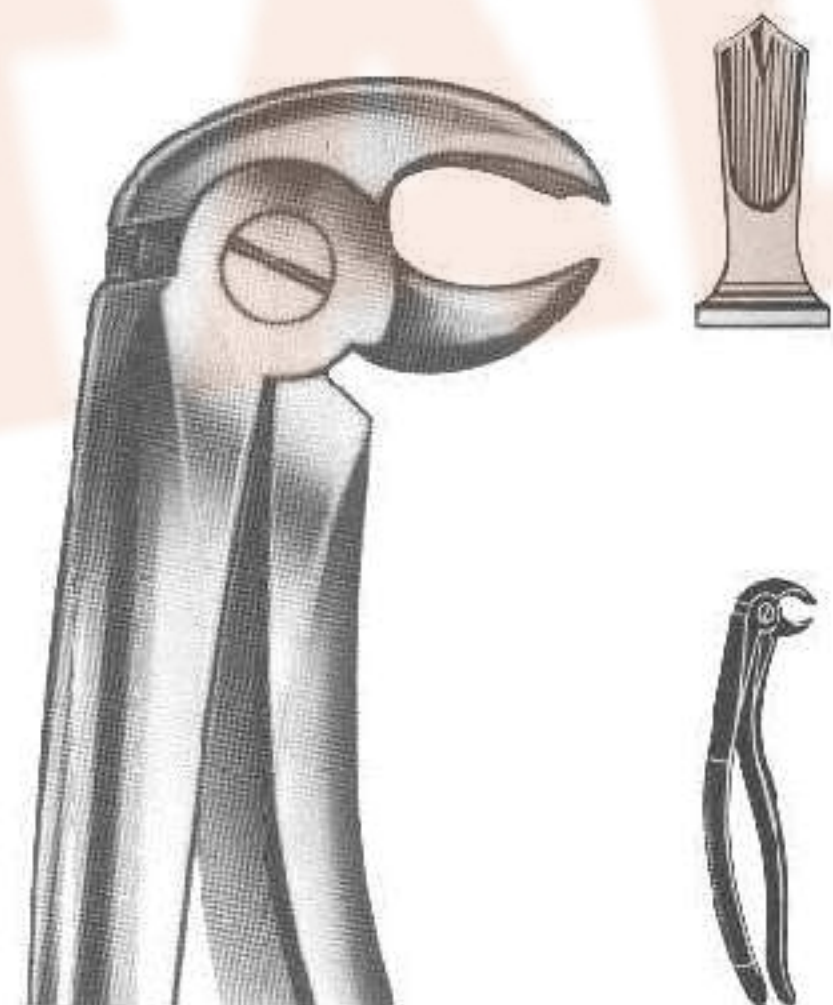

1010
Fig 22 A
Albrecht
lower molars



Extracting Forceps - English Pattern

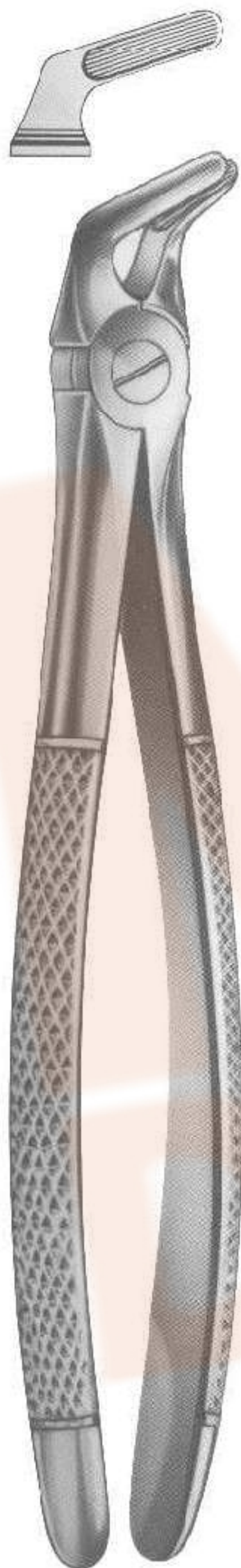

1001
Fig 8
lower premolars



1002
Fig 13
lower premolars

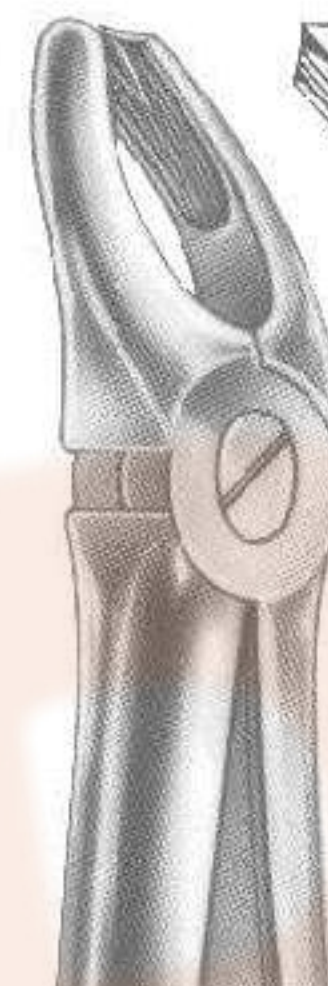
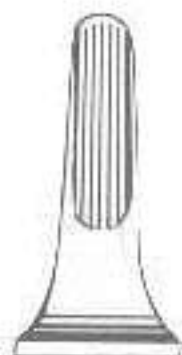

1003
Fig 17
upper molars, right

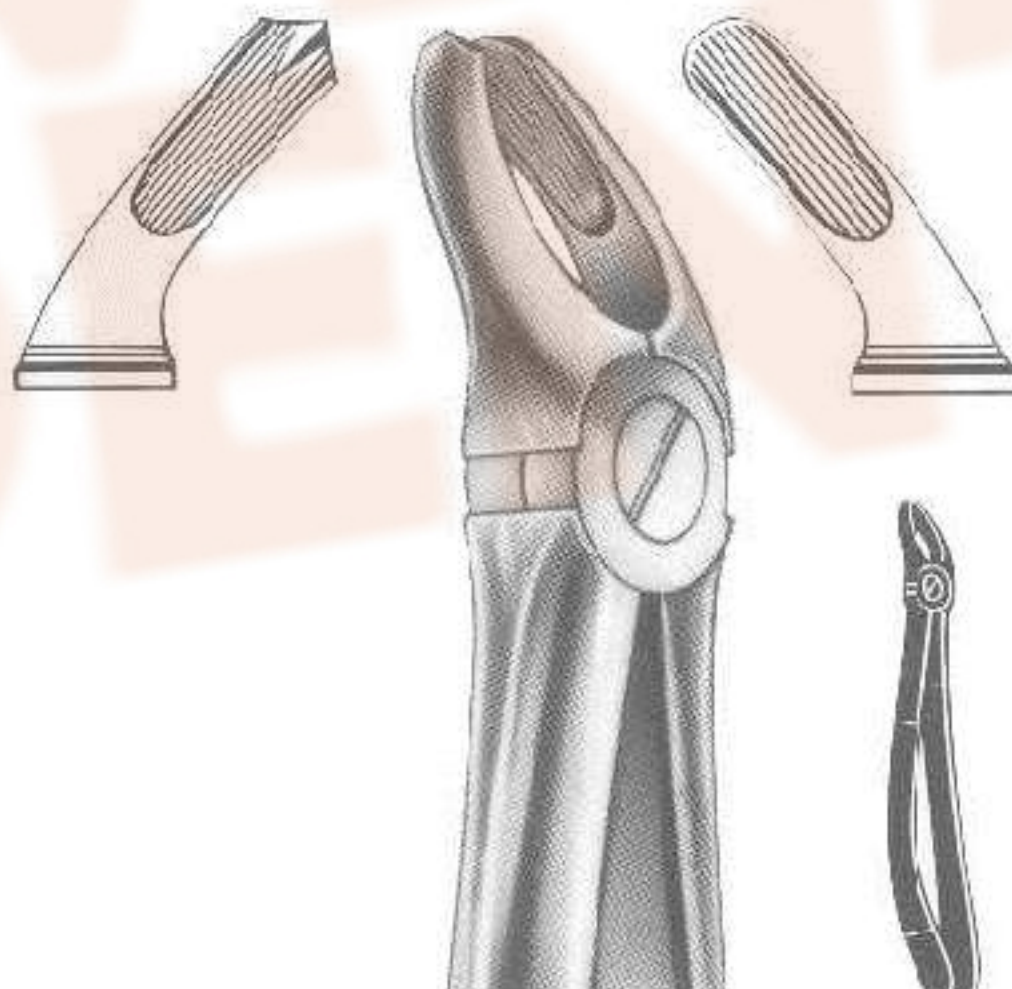
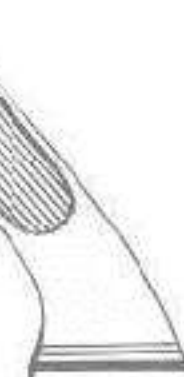

1004
Fig 18
upper molars, left



1005
Fig 18 A
upper molars

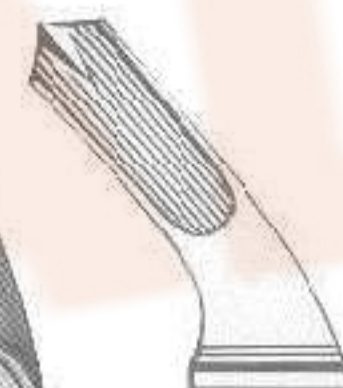



Extracting Forceps - English Pattern

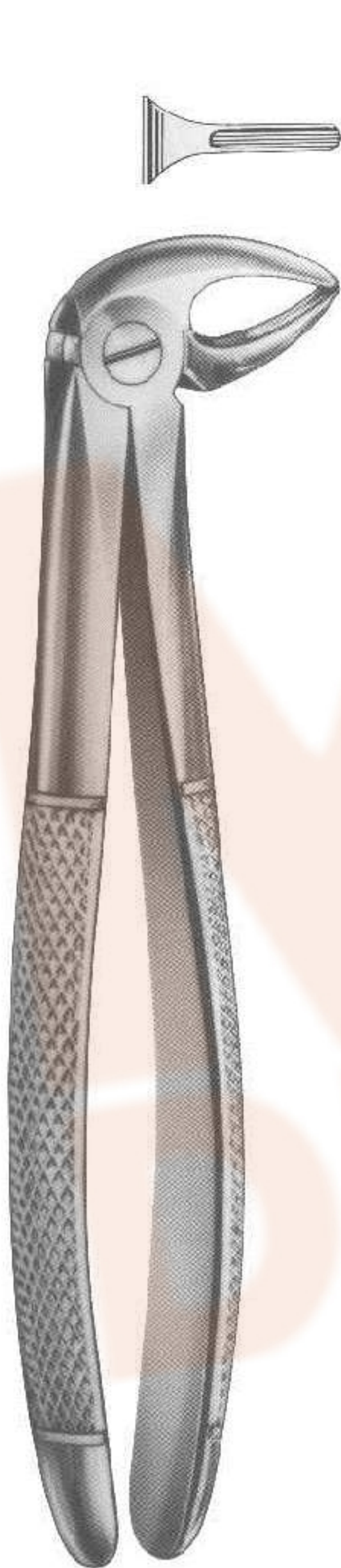

1011
Fig 33 A
lower roots

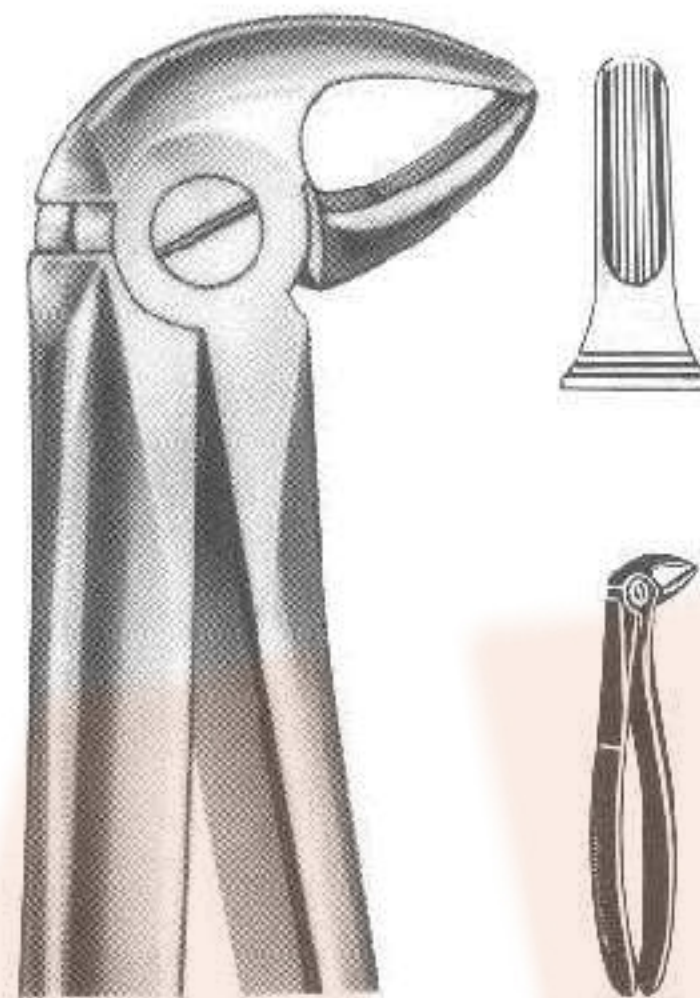

1012
Fig 33 B
lower roots

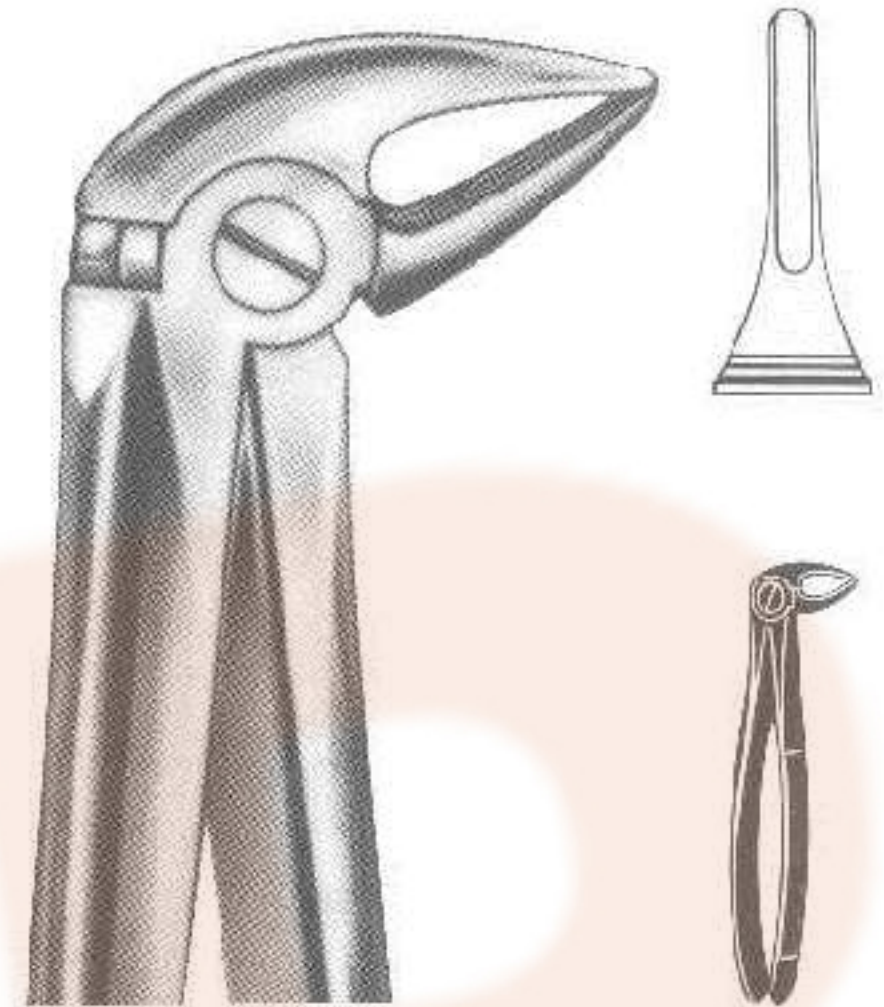

1013
Fig 33 L
lower roots

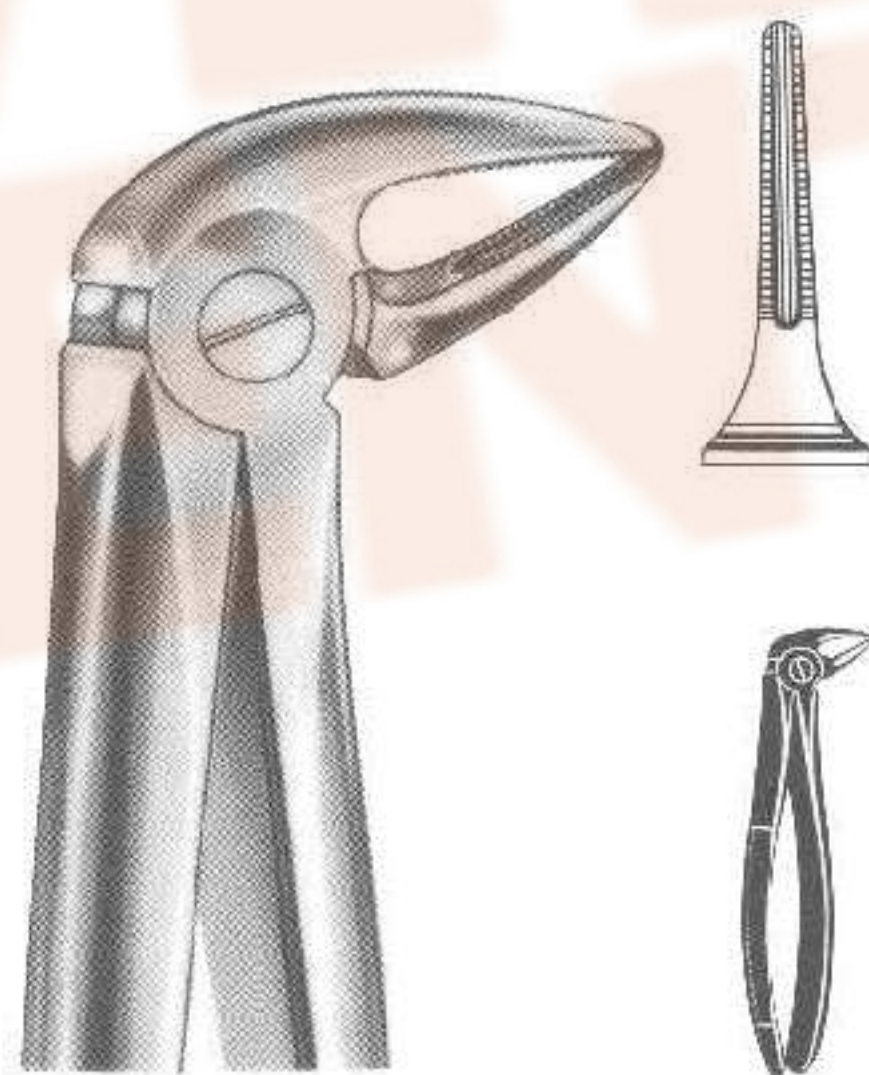

1014
Fig 33 L
lower roots

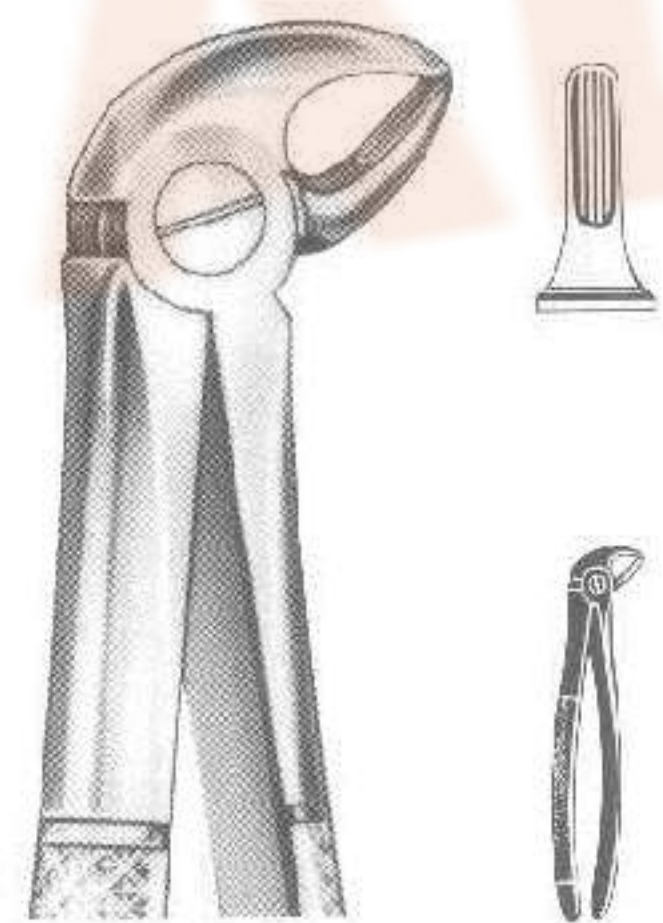

1015
Fig 33 S
lower roots, for children

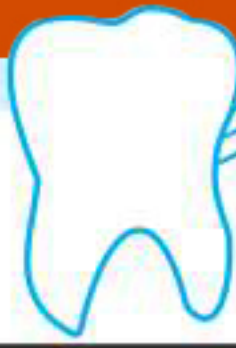

Extracting Forceps - English Pattern

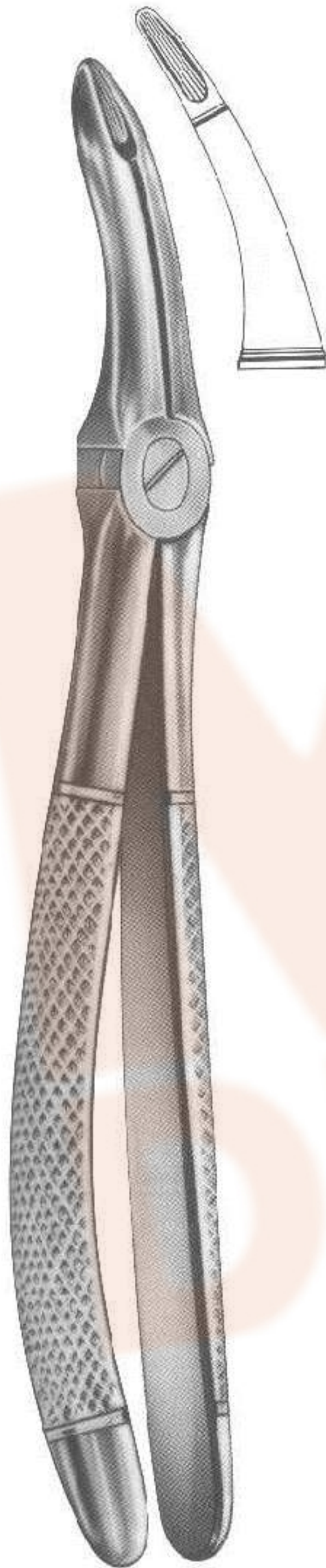

1016
Fig 44
upper roots

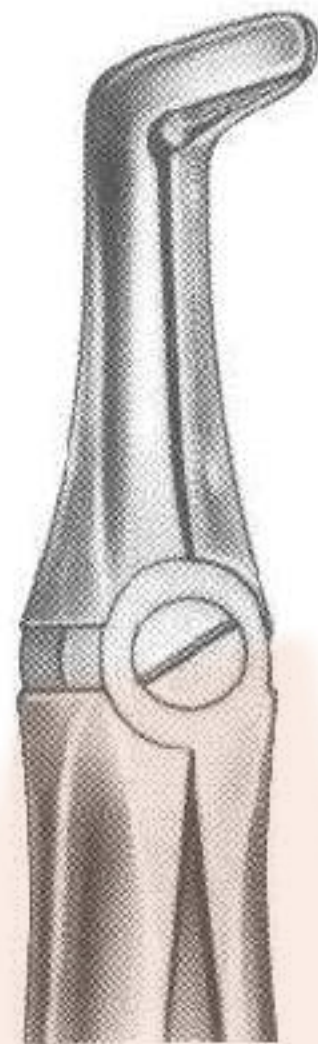

1017
Fig 45
lower roots



1019
Fig 51 A
upper roots

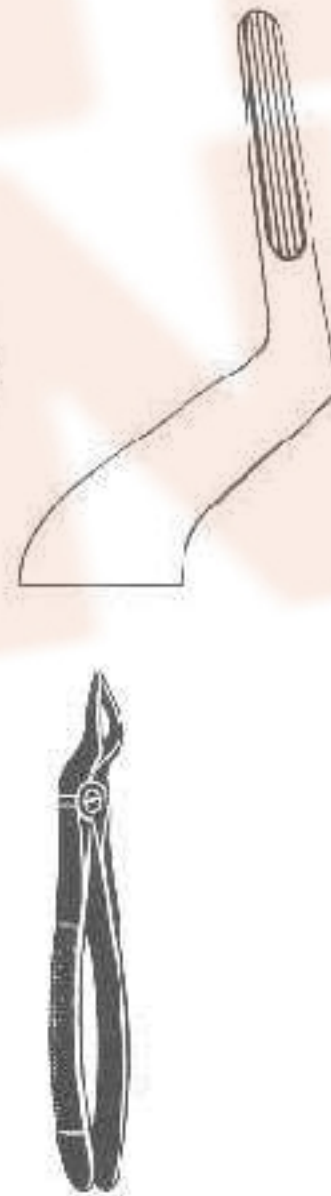

1020
Fig 51 L
upper roots

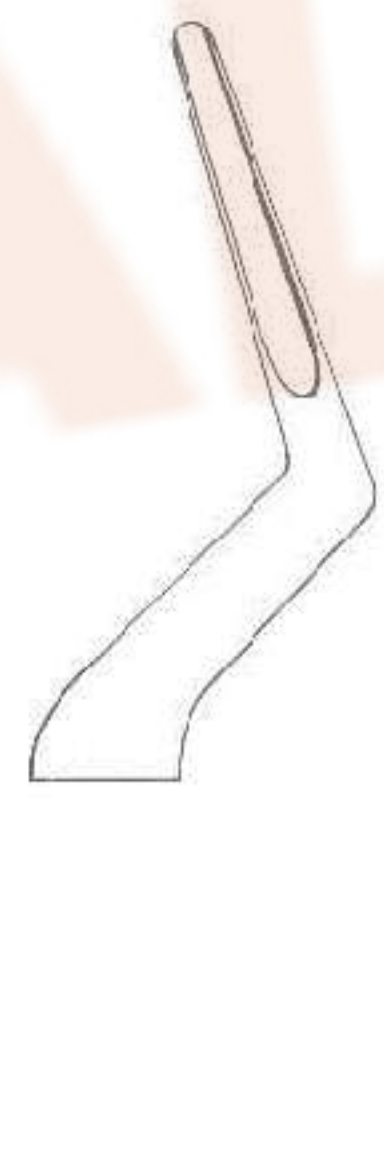
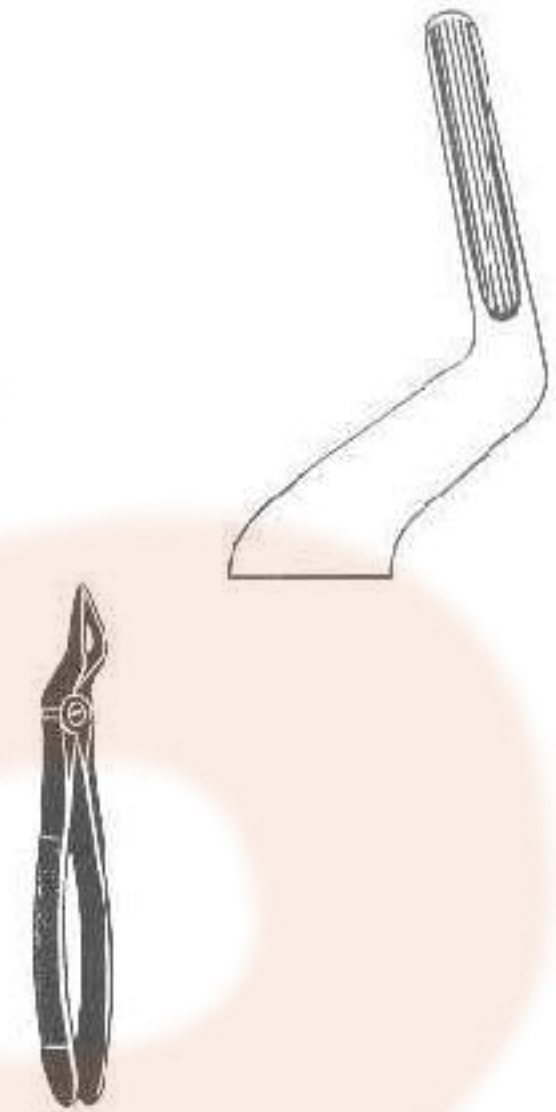



"Relax" - Extracting Forceps

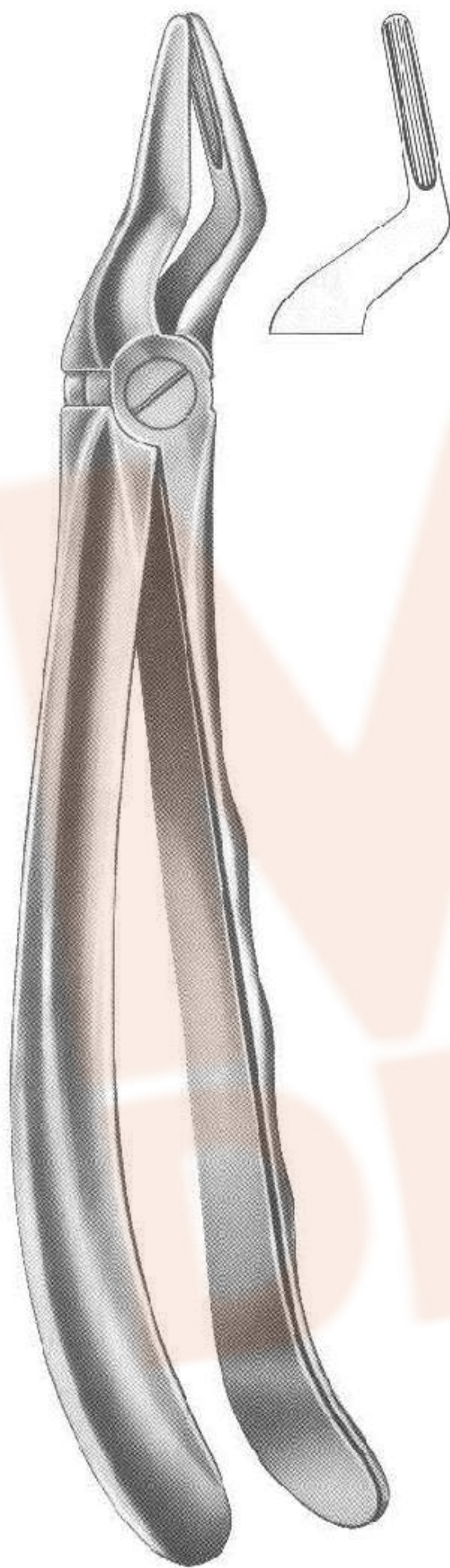

**Relax
1021**
Fig 51
upper roots

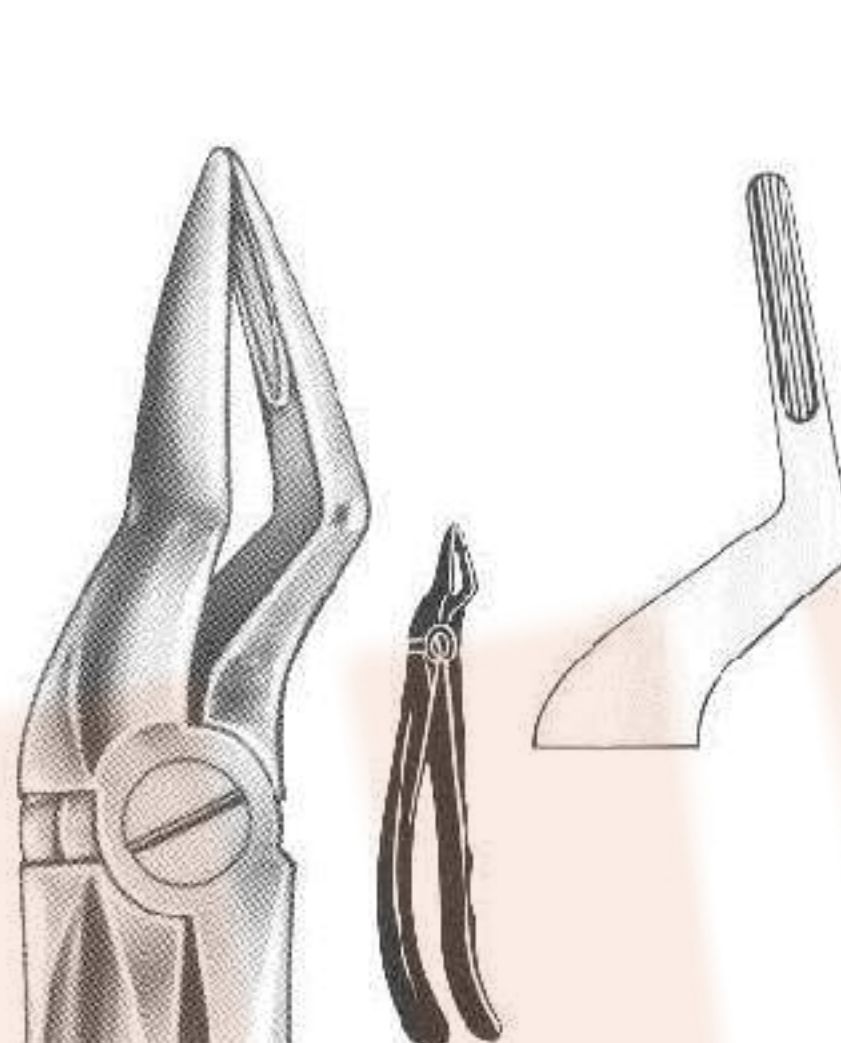

**Relax
1022**
Fig 51 A
upper roots

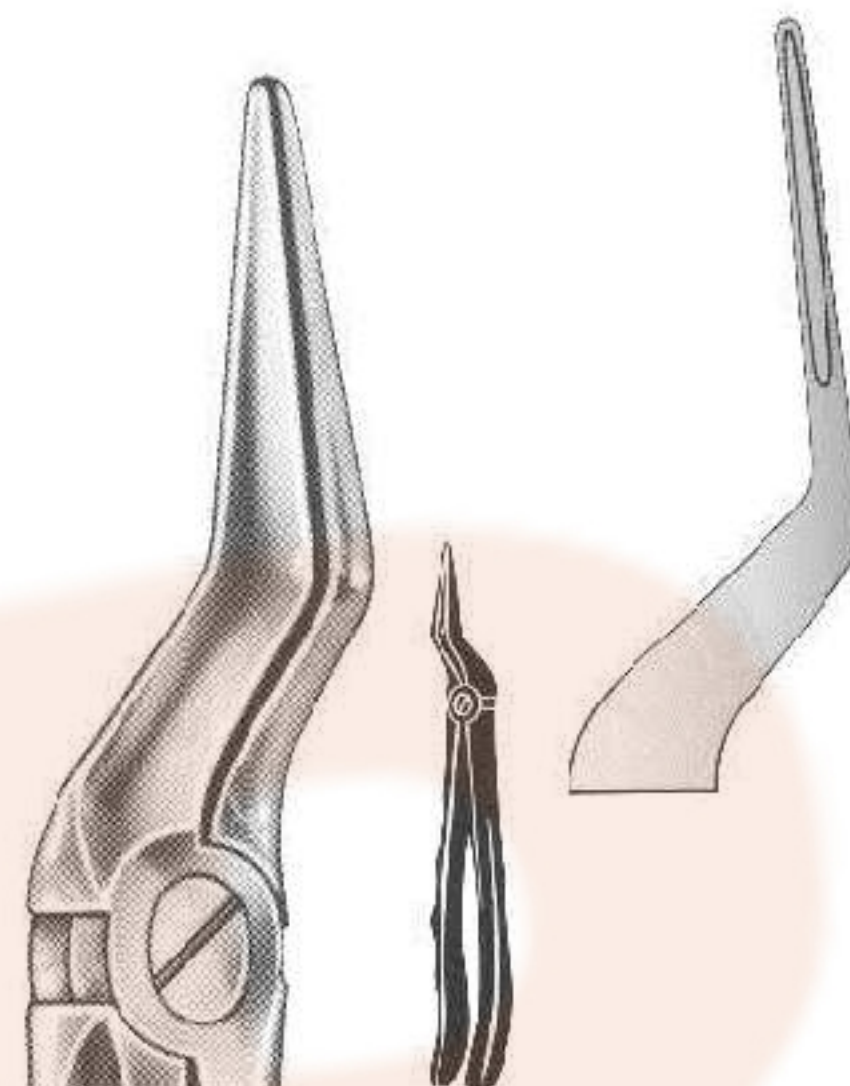

**Relax
1023**
Fig 51 L
upper roots

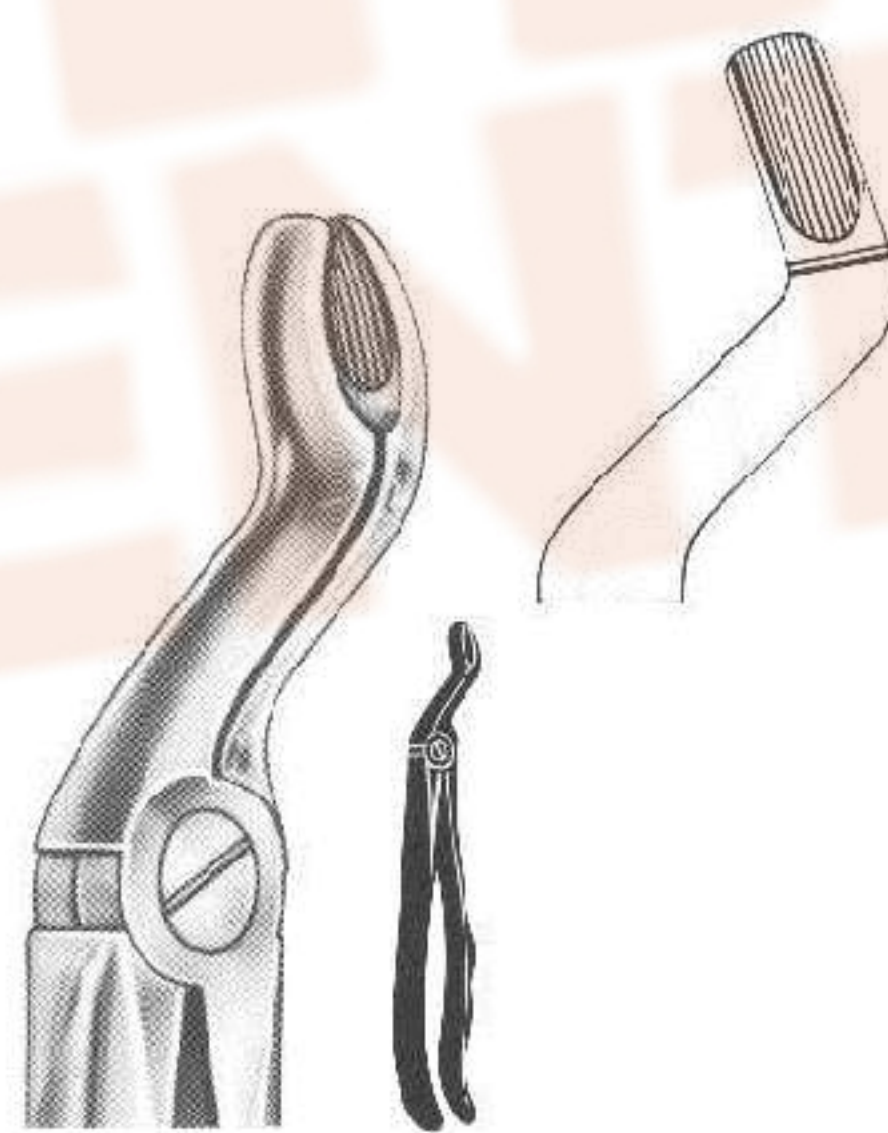

**Relax
1024**
Fig 67
upper wisdoms

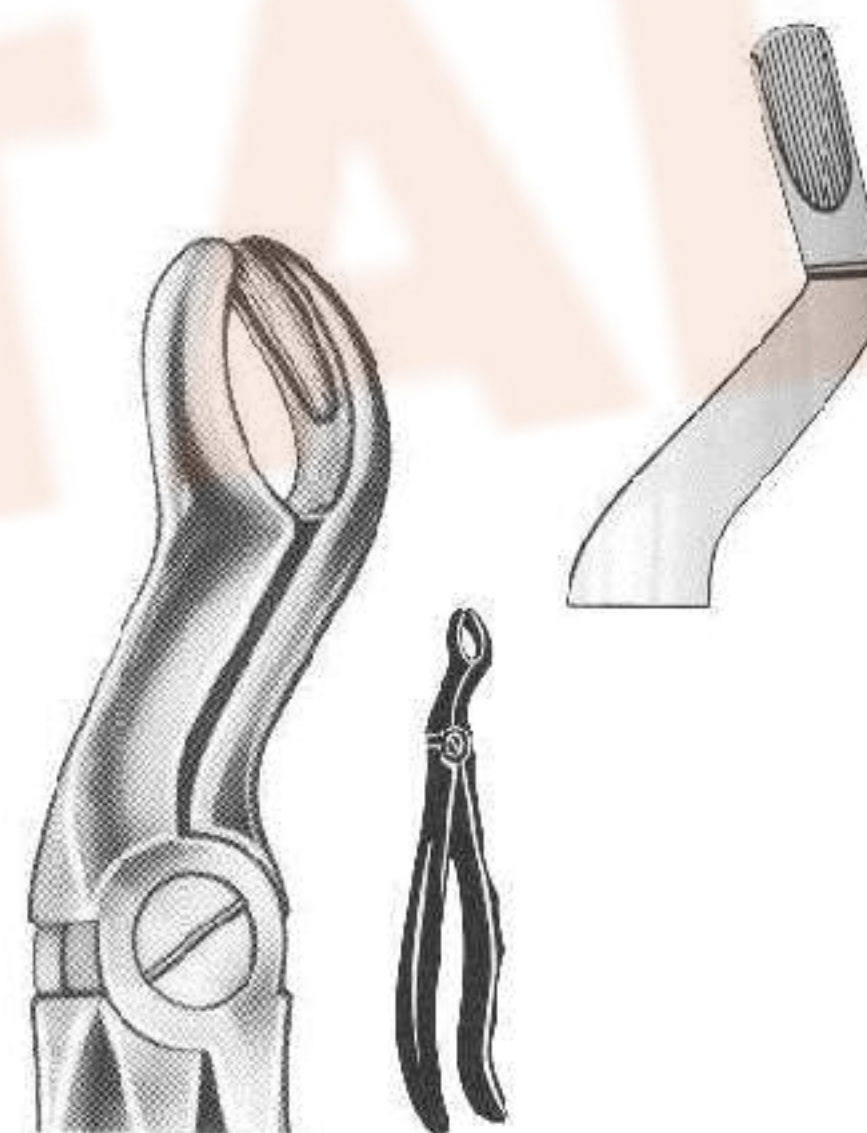

**Relax
1025**
Fig 67 A
upper wisdoms



"Relax" - Extracting Forceps

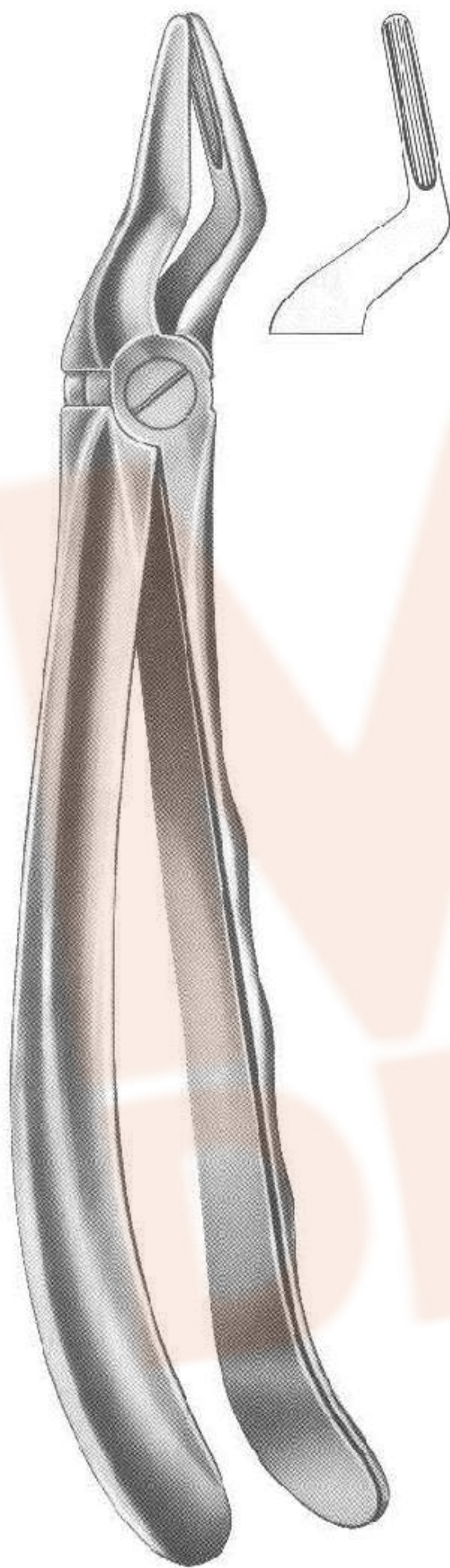

Relax 1021
Fig 51
upper roots

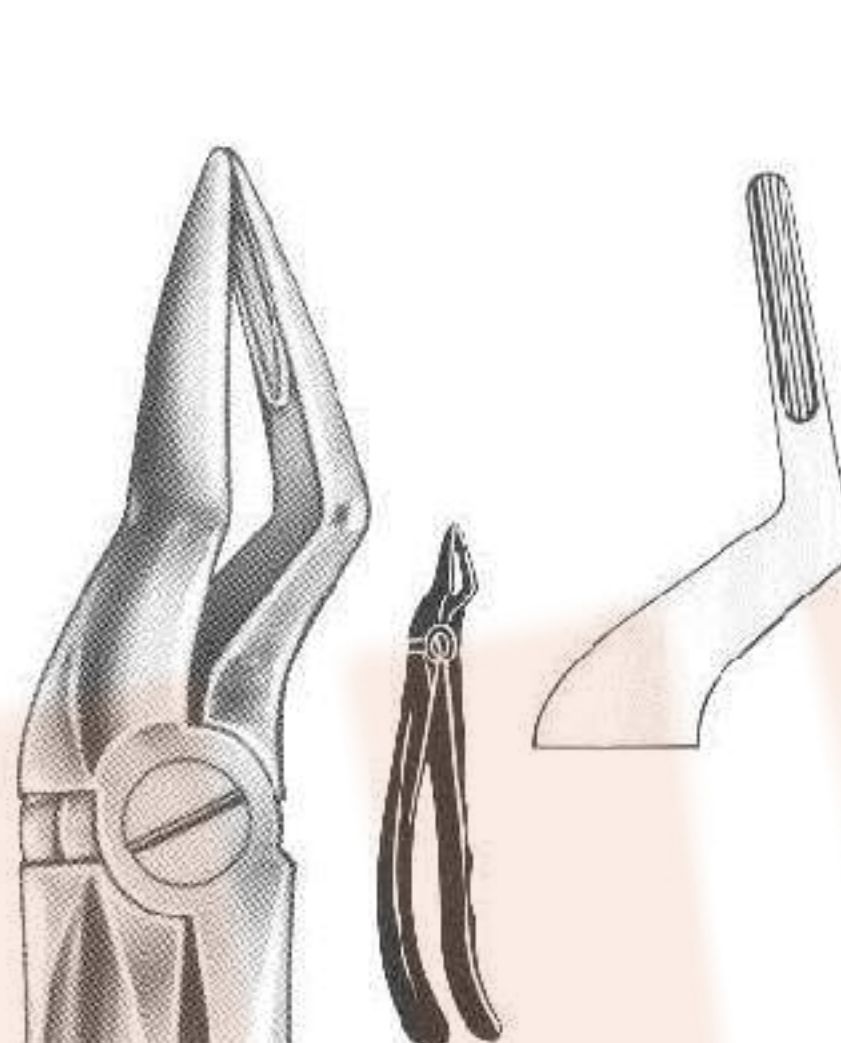

Relax 1022
Fig 51 A
upper roots

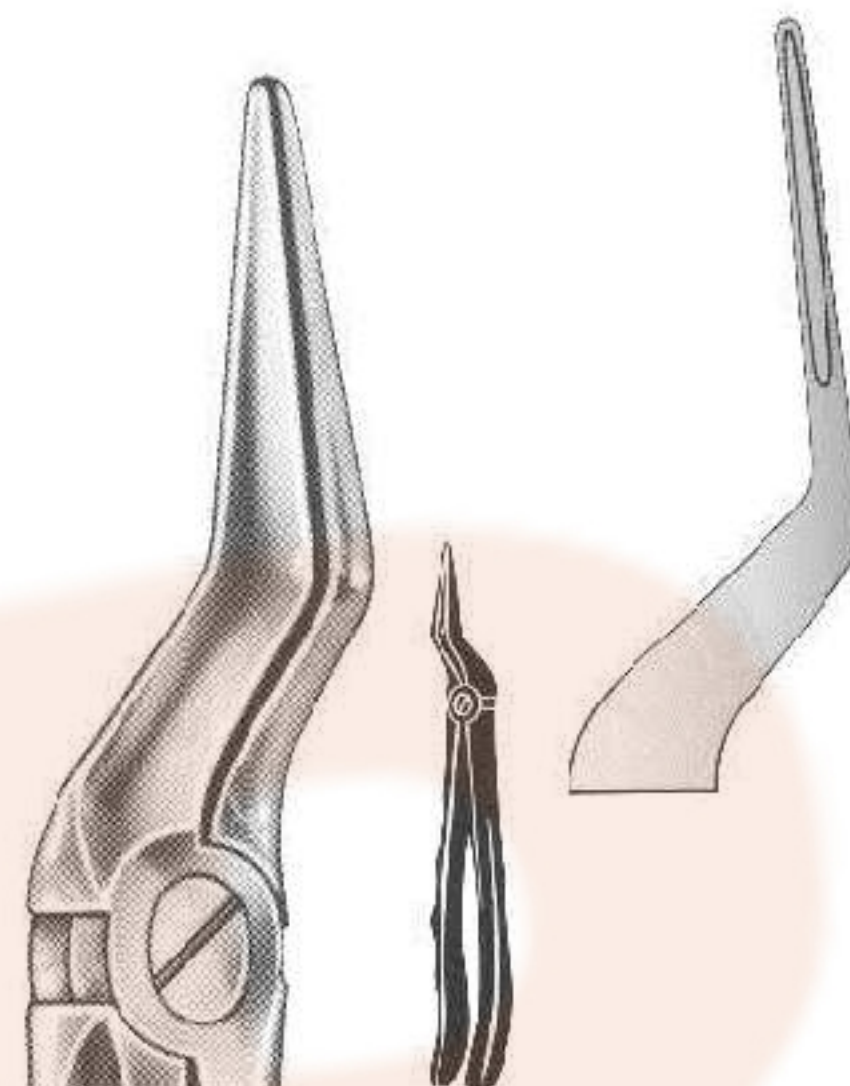

Relax 1023
Fig 51 L
upper roots

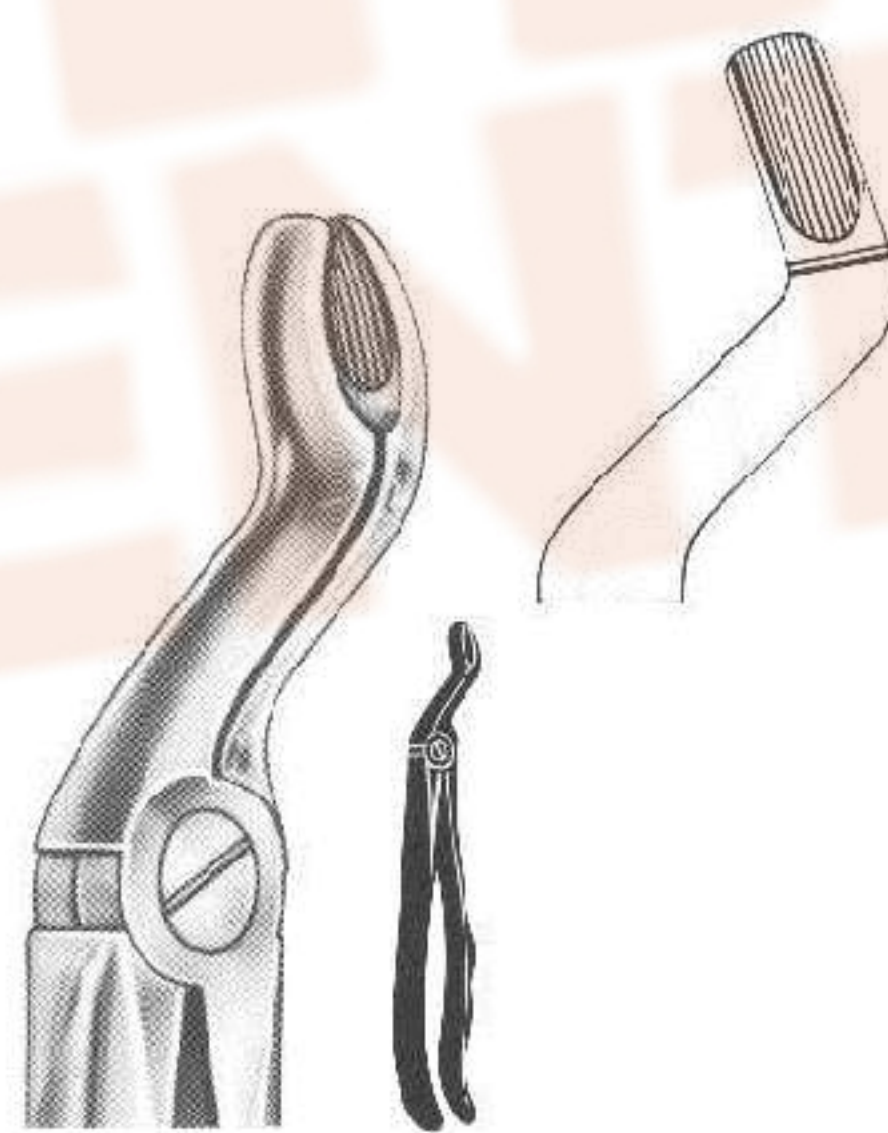

Relax 1024
Fig 67
upper wisdoms

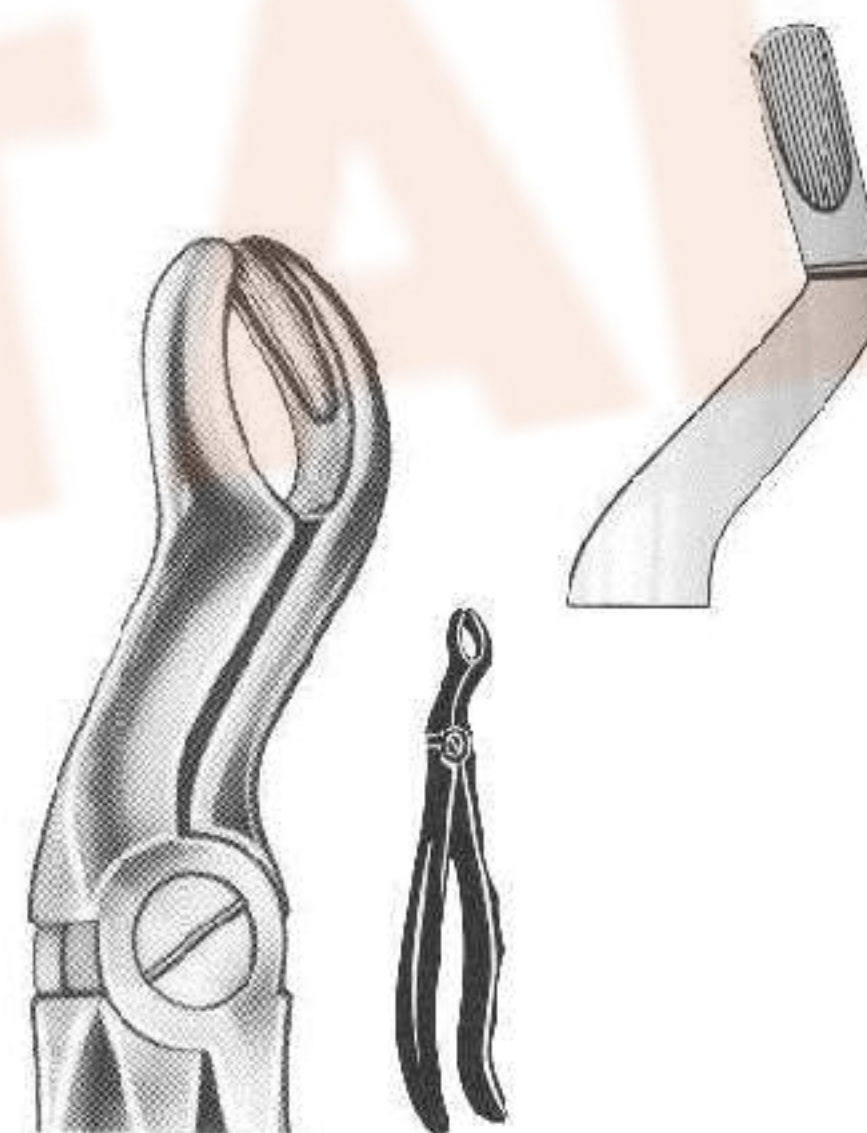

Relax 1025
Fig 67 A
upper wisdoms

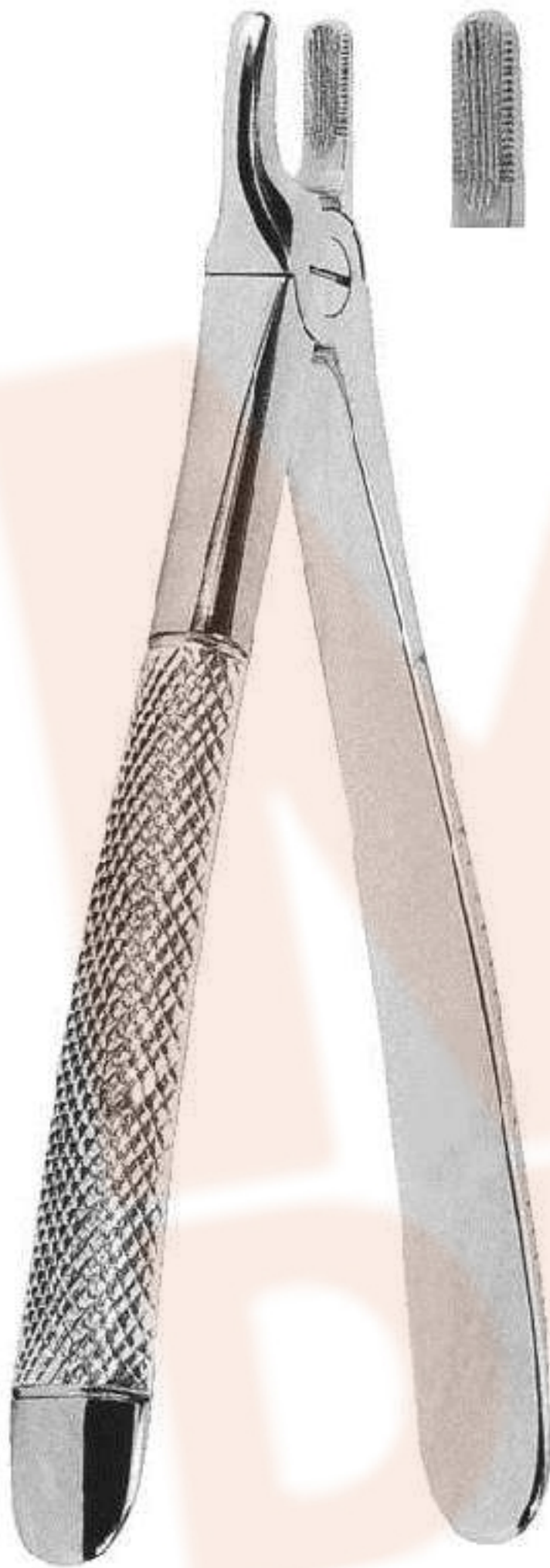

1026
Fig 37
Upper incisors



WITH SERRATED
TIPS

1027
Fig 39
Upper molars



WITH SERRATED
TIPS

1028
Fig 39 R
Upper molars, right



WITH SERRATED
TIPS

1029
Fig 39 L
Upper molars, left



WITH SERRATED
TIPS

1030
Fig 515
Upper roots

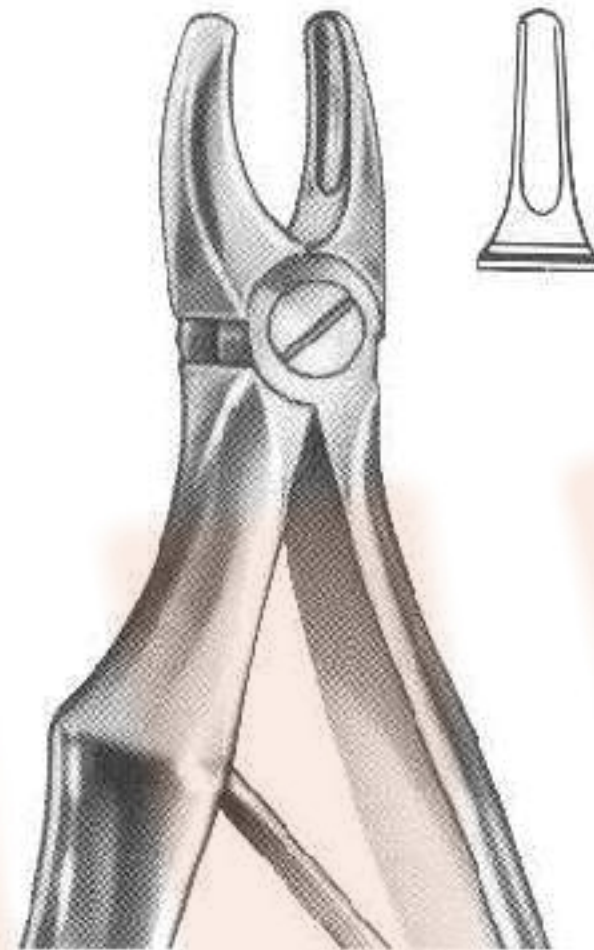
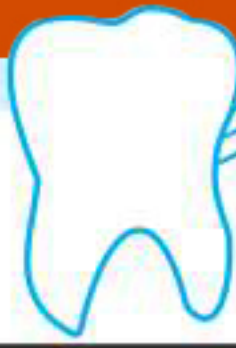

**Klein
1032**
Fig 137
upper incisors

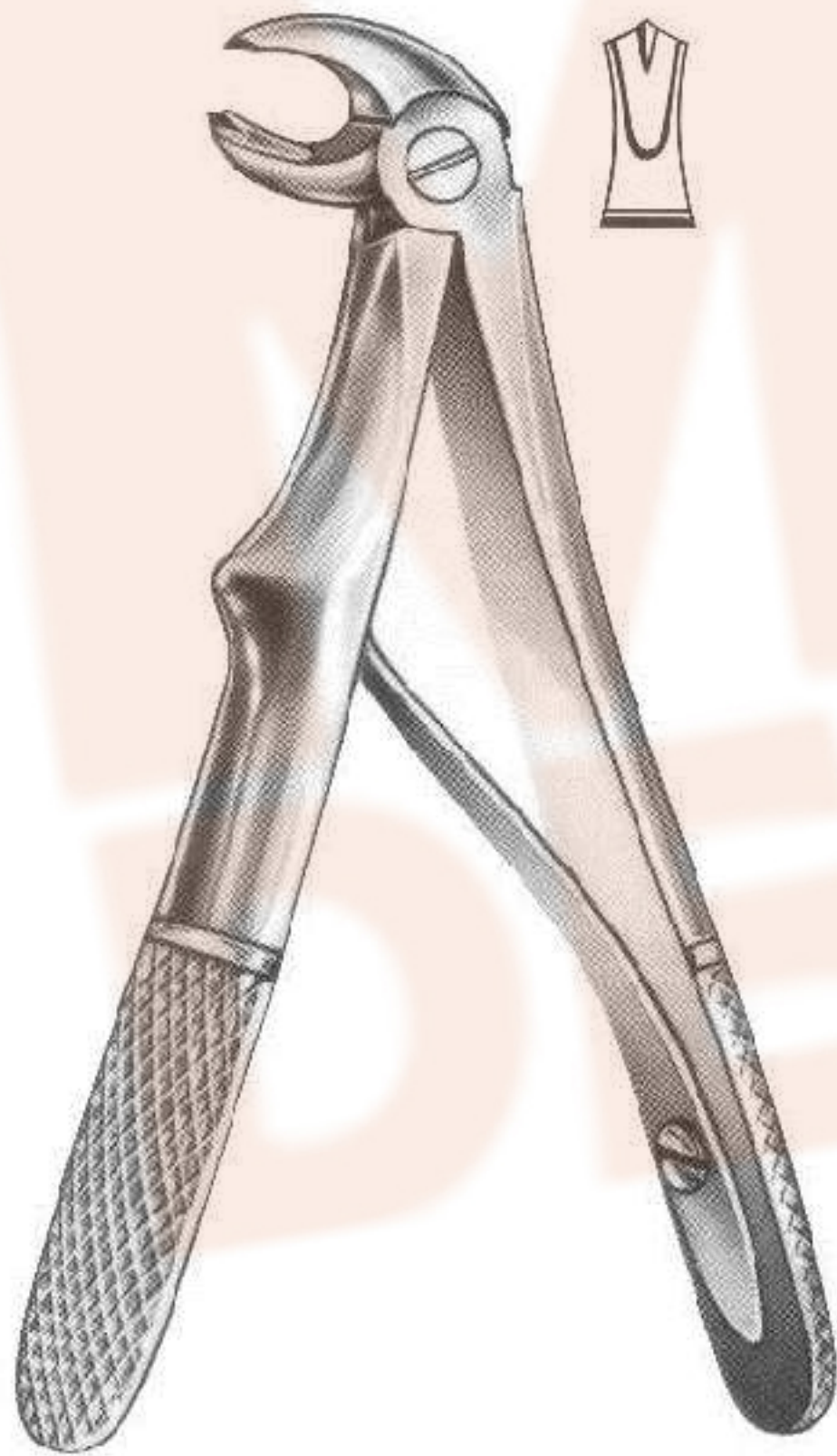

**Klein
1031**
Fig 6
lower molars



**Klein
1033**
Fig 5
lower incisors

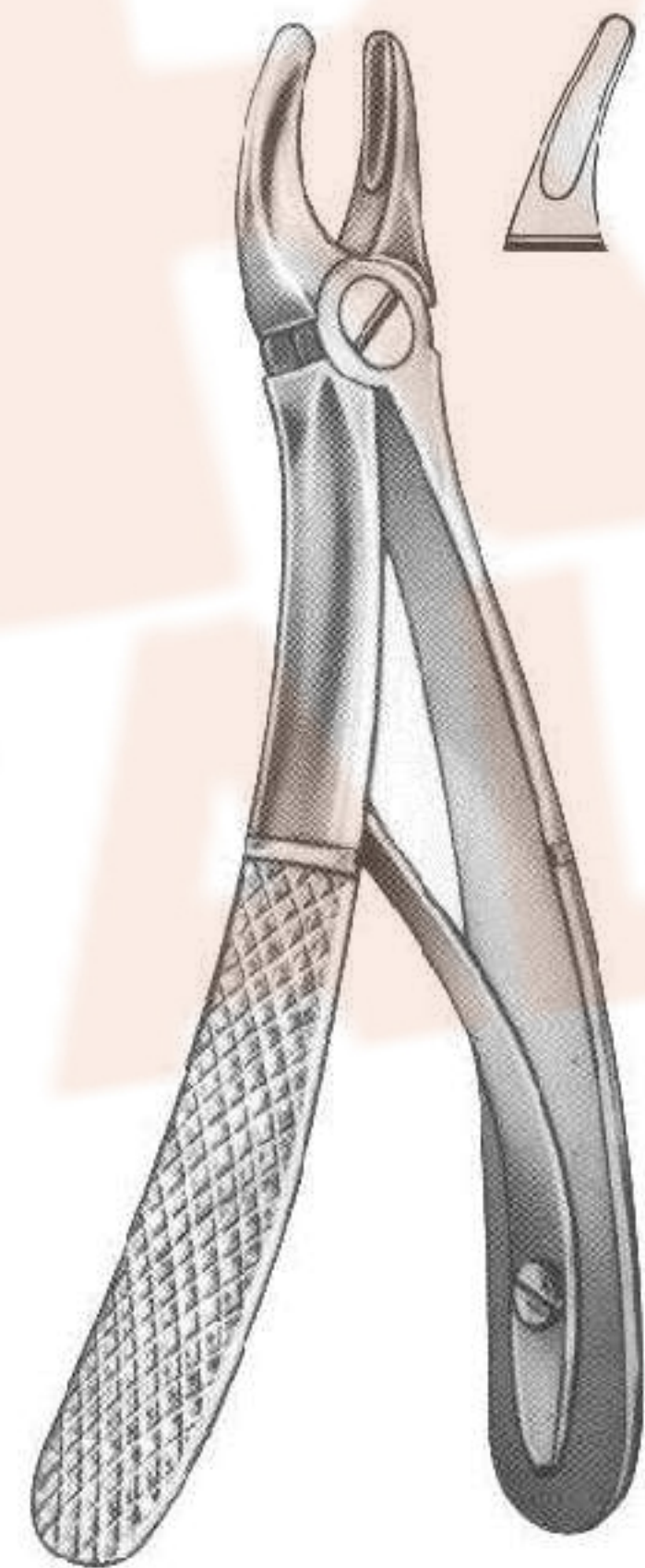

**Klein
1034**
Fig 139
uper premolars

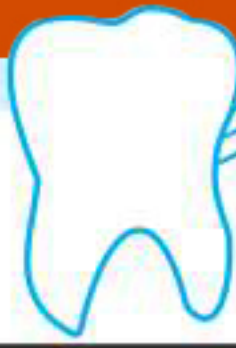

Extracting Forceps - English Pattern

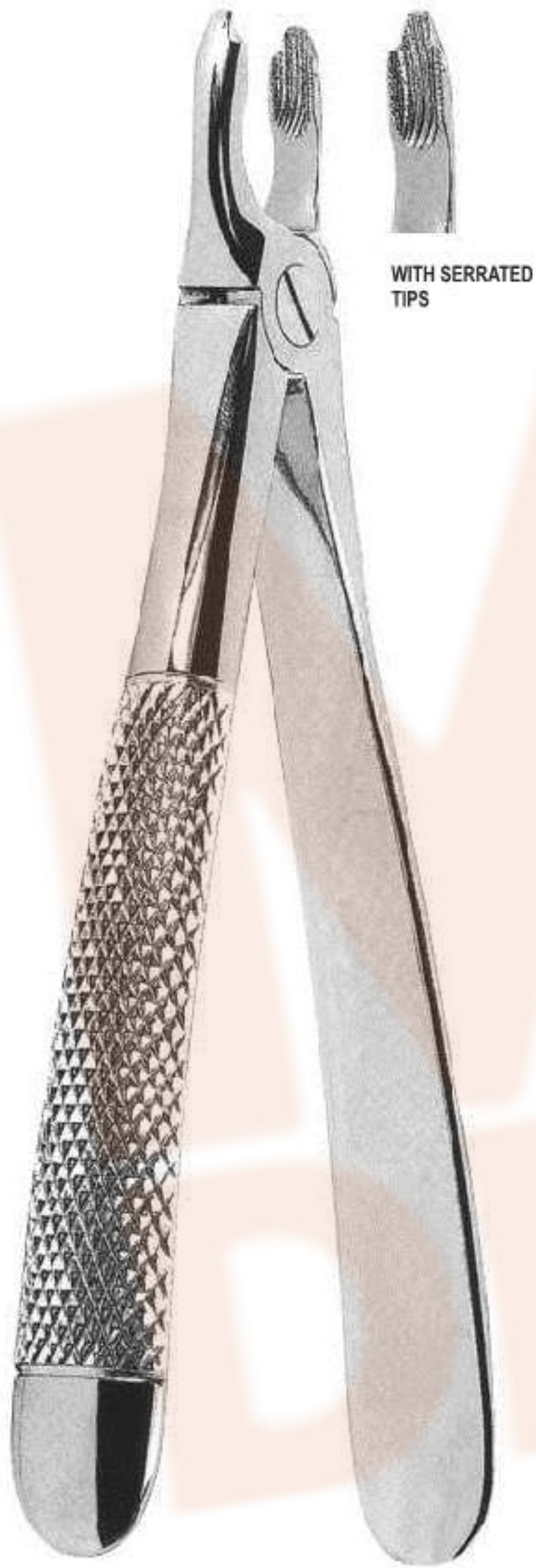

1035
Fig 43 A
Fractured or decayed
upper teeth

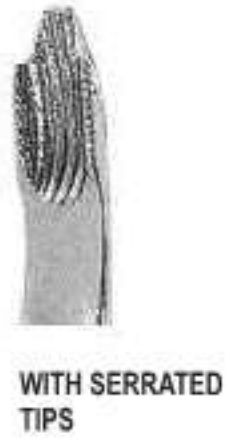

WITH SERRATED
TIPS

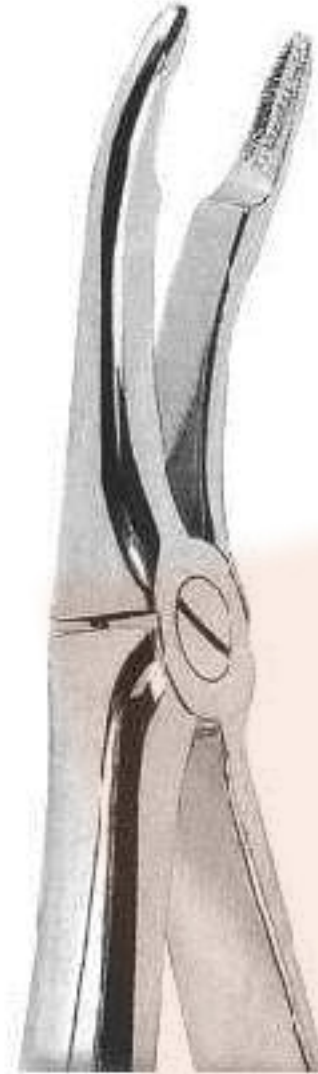

1036
Fig 44
Upper roots



WITH SERRATED
TIPS

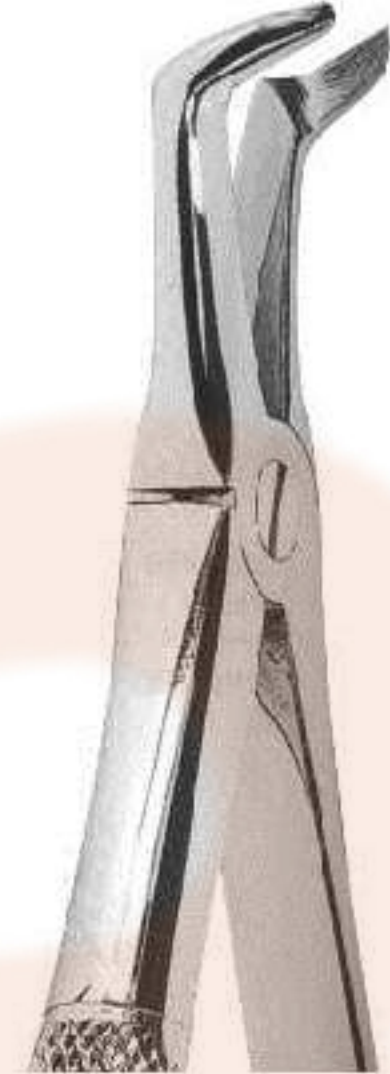

1037
Fig 45
Lower roots



WITH SERRATED
TIPS

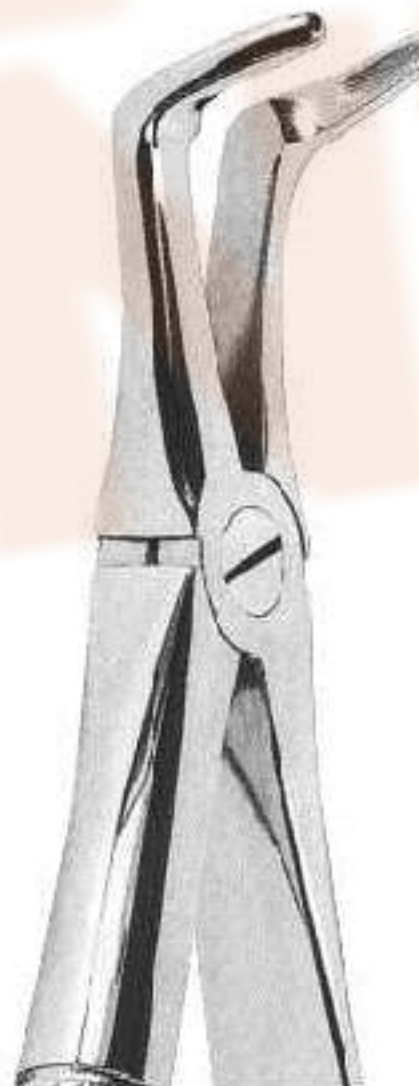

1038
Fig 46
Lower roots



WITH SERRATED
TIPS

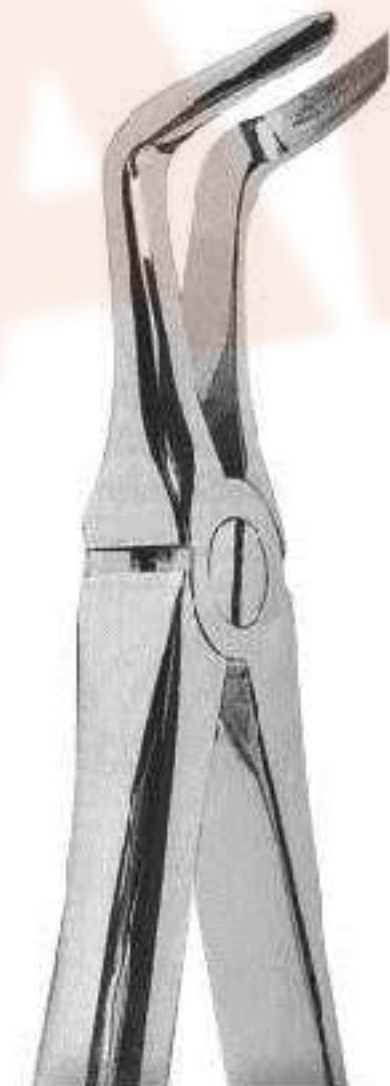

1039
Fig 46 L
Lower roots



WITH SERRATED
TIPS

Extracting Forceps - English Pattern

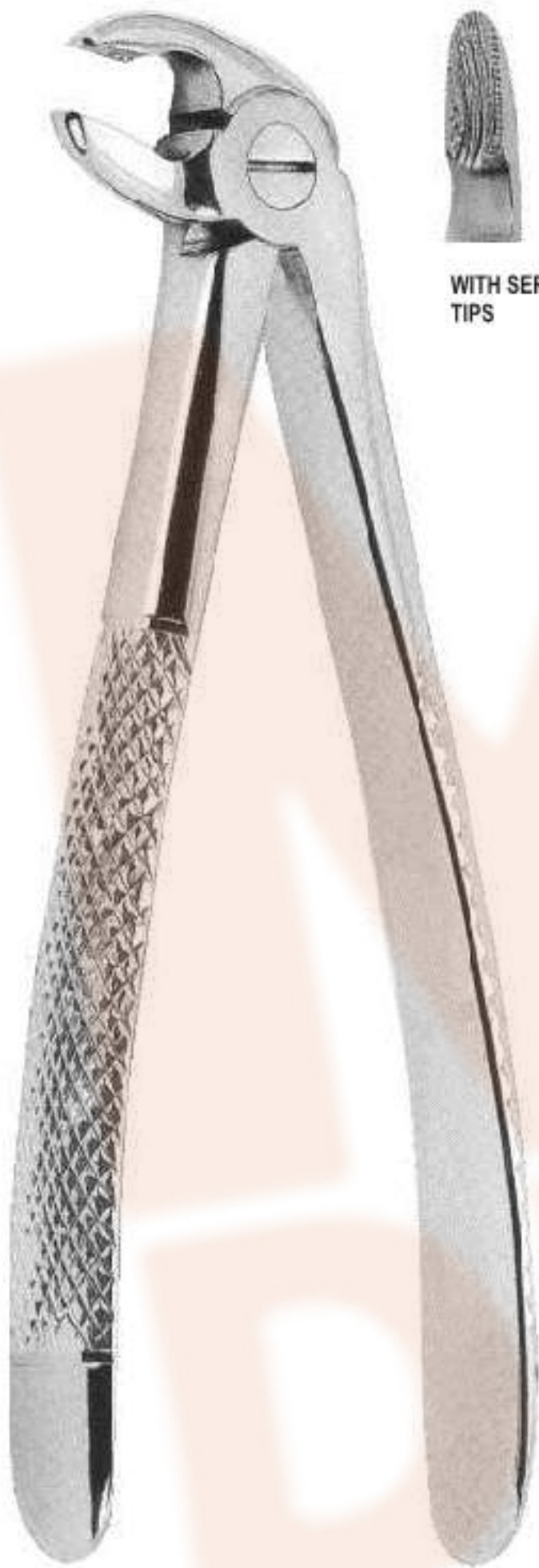

1050
Fig 59
Lower roots



WITH SERRATED
TIPS

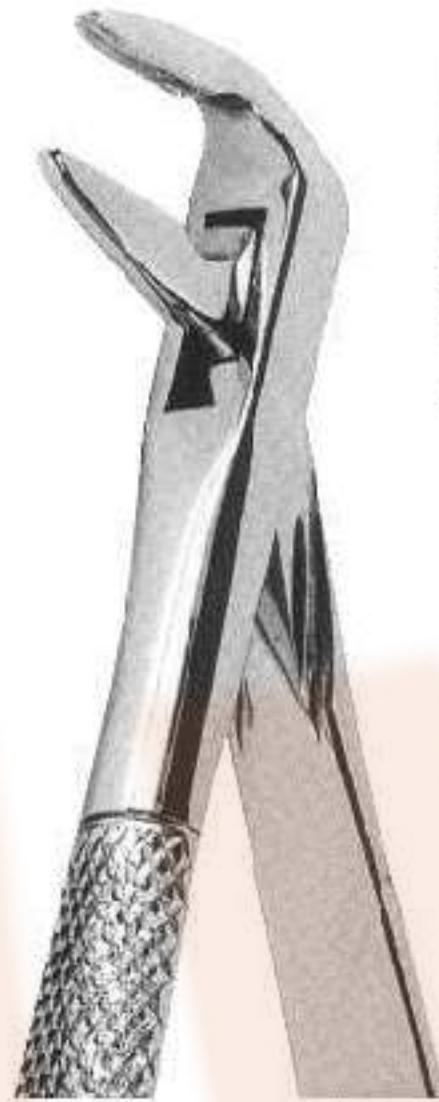

1051
Fig 59 L
Lower incisor
roots



WITH SERRATED
TIPS

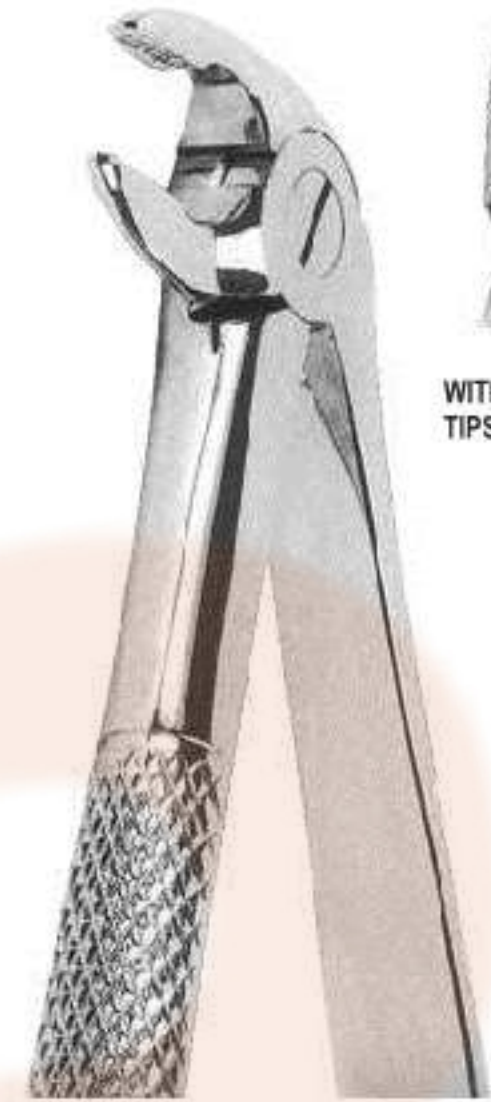

1052
Fig 60
Lower roots



WITH SERRATED
TIPS

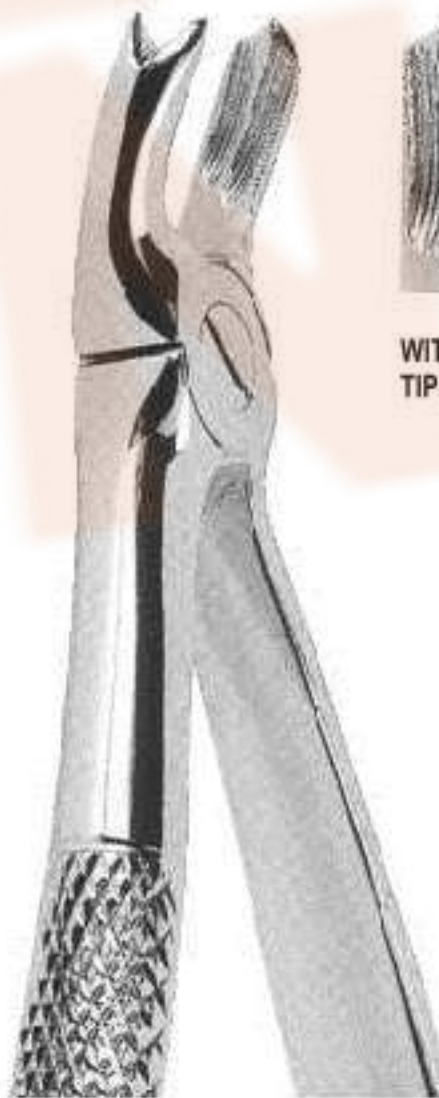

1053
Fig 65 L
Upper molars, left



WITH SERRATED
TIPS



1054
Fig 65 R
Upper molars, right



WITH SERRATED
TIPS

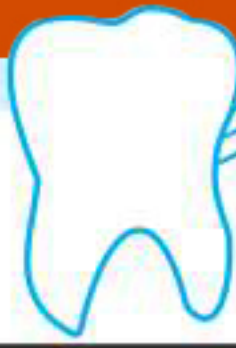

Extracting Forceps - English Pattern

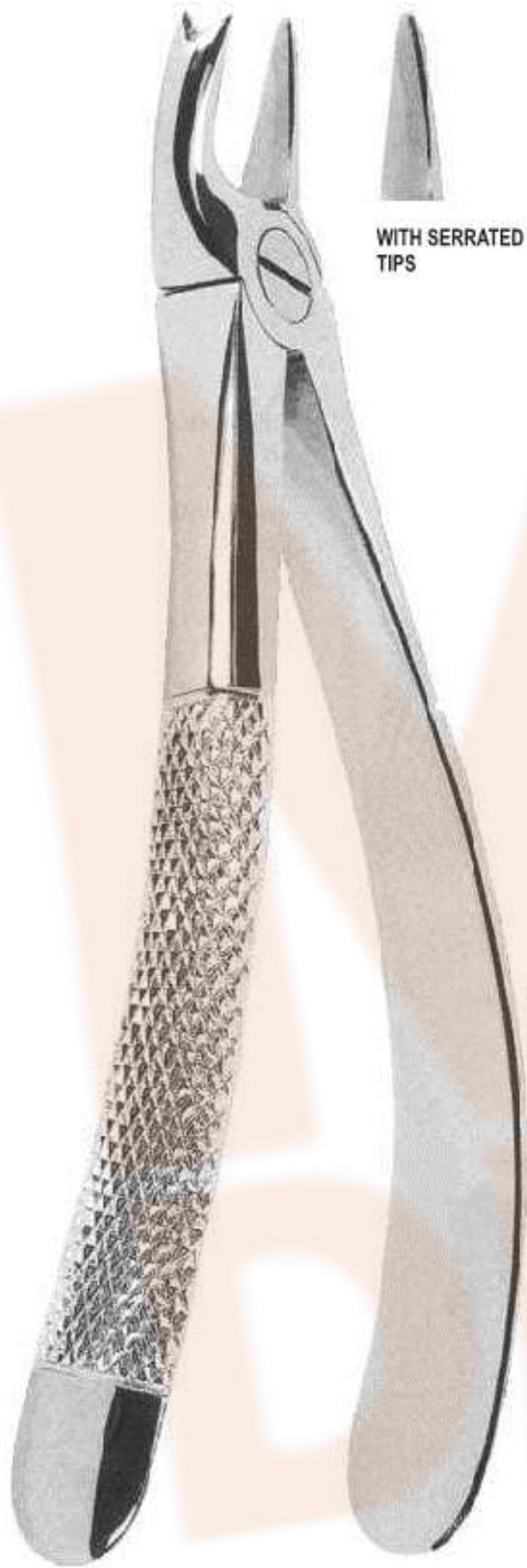

WITH SERRATED TIPS

1055
Fig 66 L
Upper molars, left

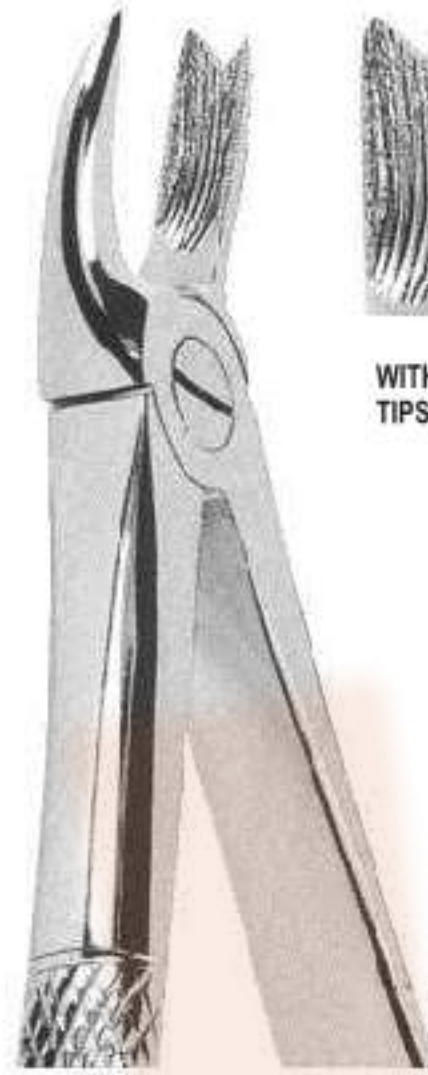

WITH SERRATED TIPS

1056
Fig 66 R
Upper molars, right

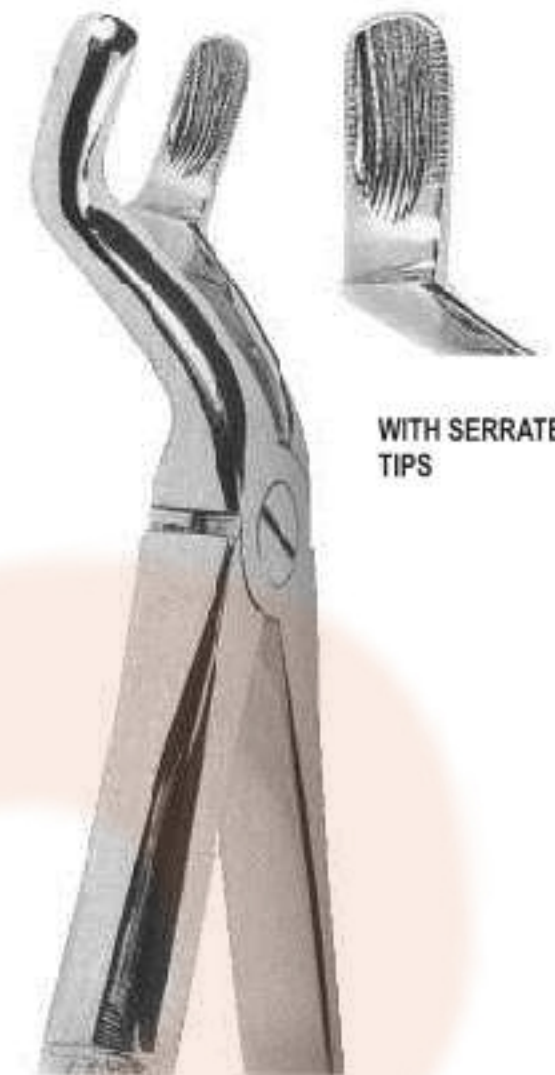

WITH SERRATED TIPS

1057
Fig 67
Upper third molars



WITH SERRATED TIPS

1058
Fig 67 A
Upper third molars

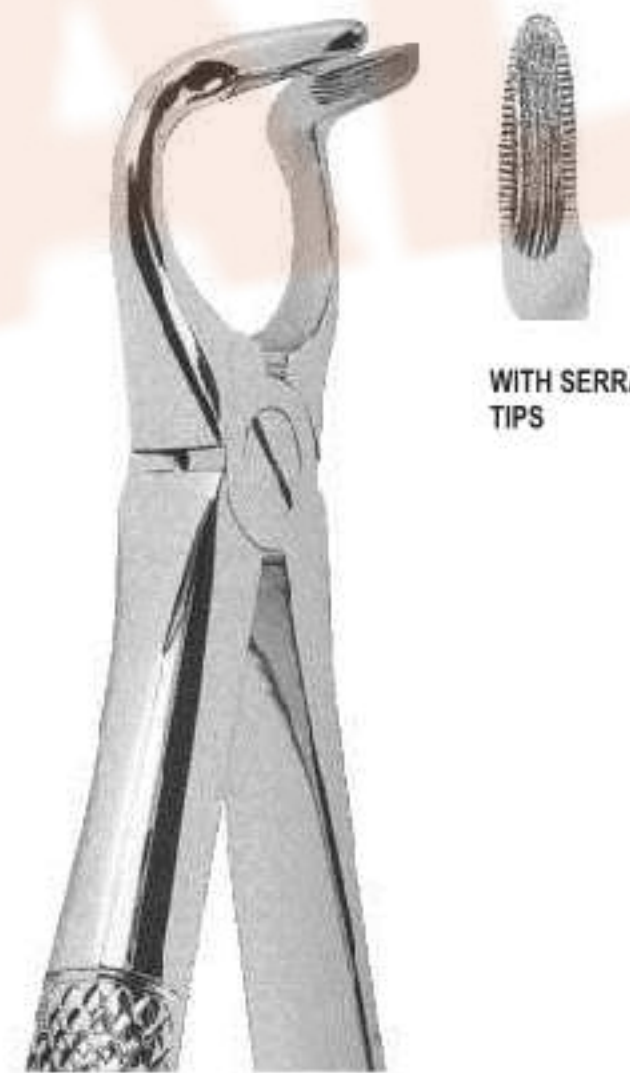

WITH SERRATED TIPS

1059
Fig 68
Lower roots

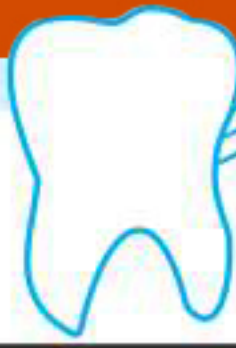

Extracting Forceps - English Pattern

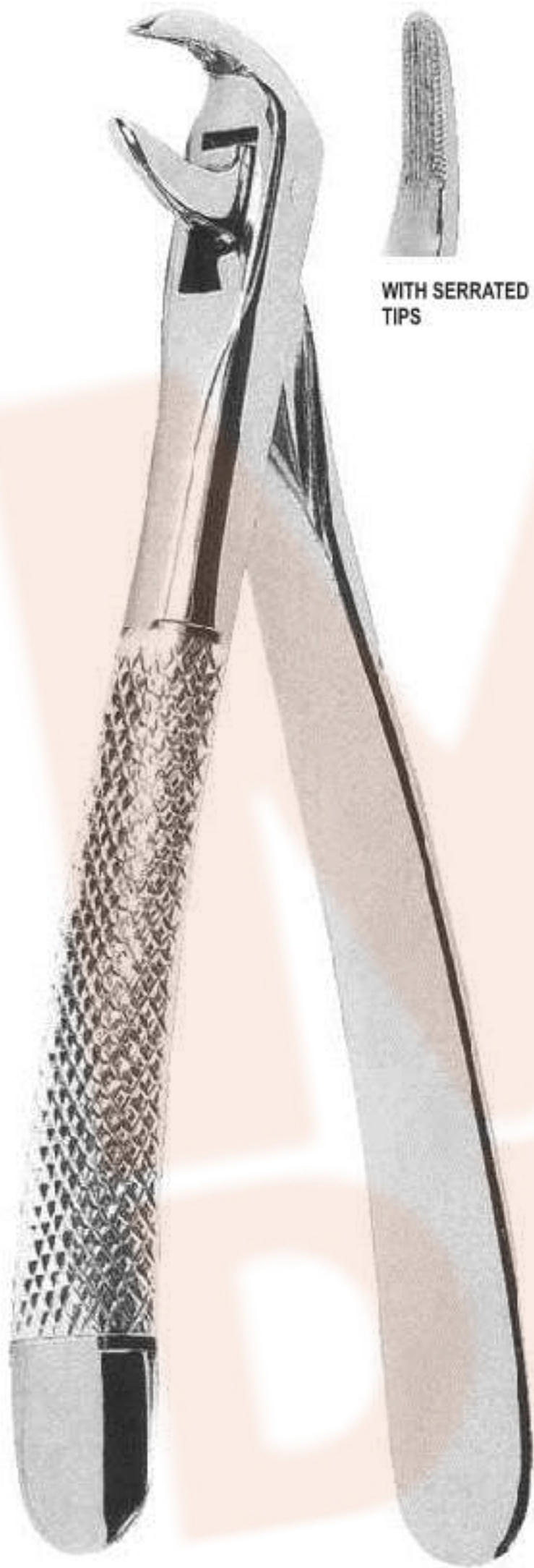

1065
Fig 74 N
Lower roots



WITH SERRATED TIPS

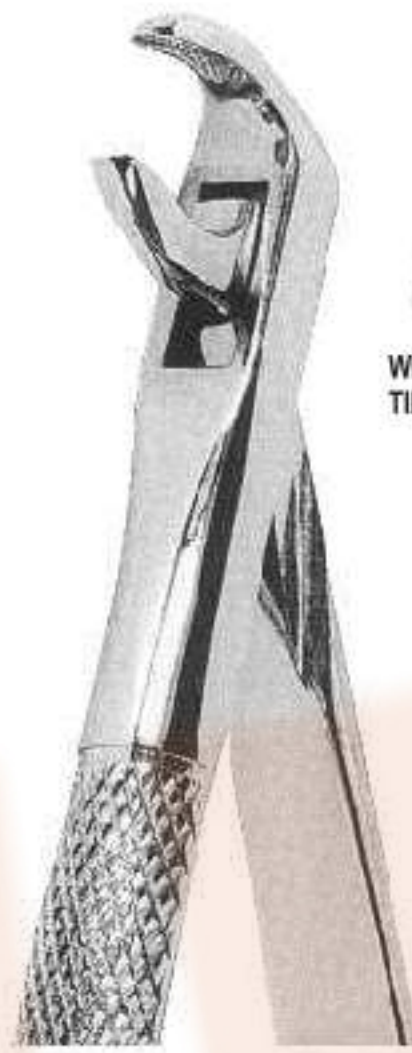

1066
Fig 75
Lower canines and premolars



WITH SERRATED TIPS

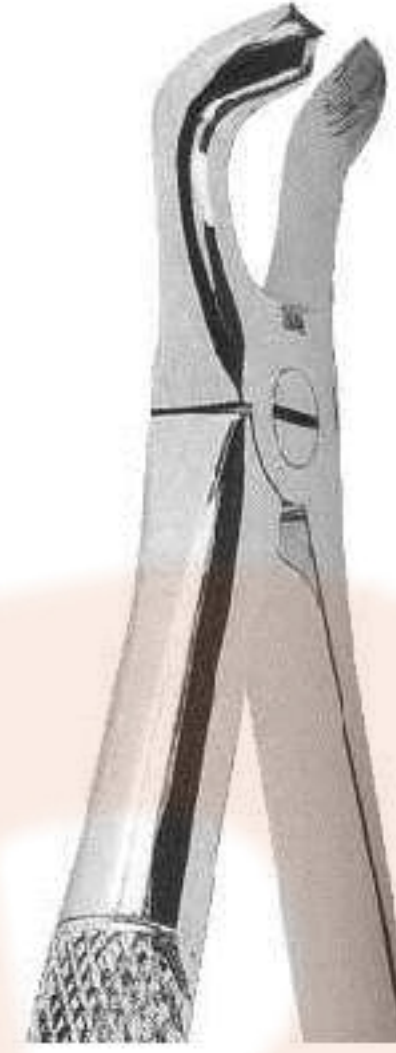

1067
Fig 79
Lower third molars



WITH SERRATED TIPS

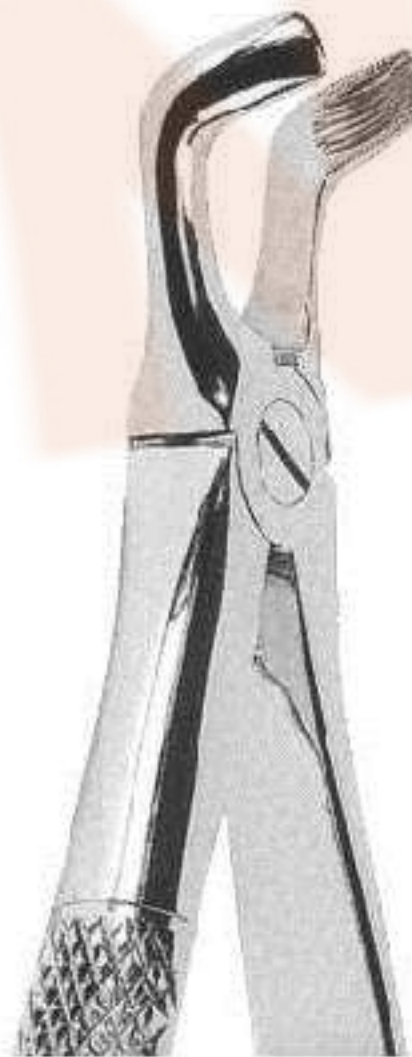

1068
Fig 79 A
Lower third molars



WITH SERRATED TIPS



1069
Fig 79 C
Lower third molars



WITH SERRATED TIPS



1070
Fig 86 W
Lower third molars

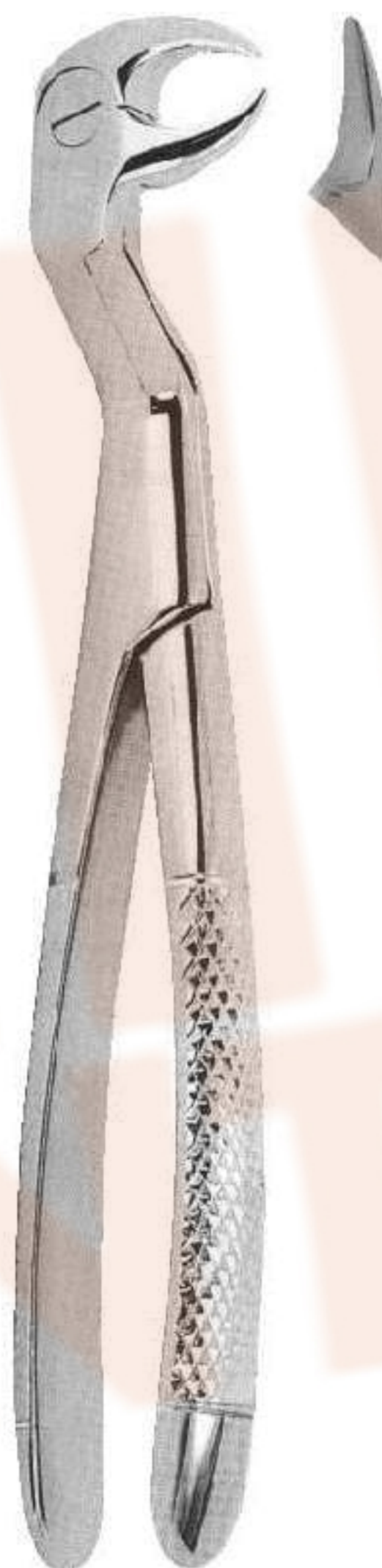

1071
Fig 86 1/2 L
Lower third molars, left



1072
Fig 86 1/2 R
Lower third molars, right

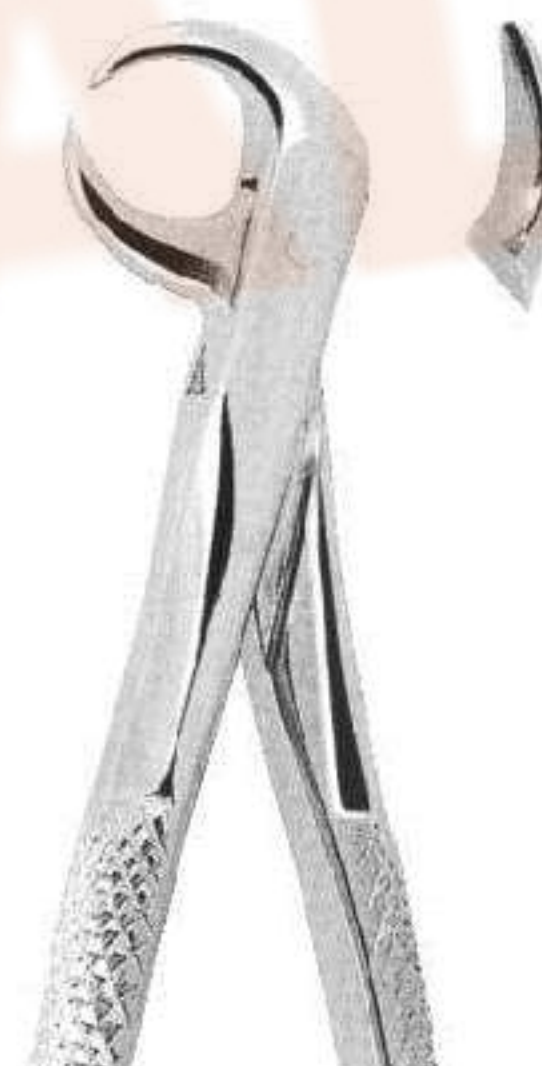

1073
Fig 86 C
Lower molars



Extracting Forceps - English Pattern

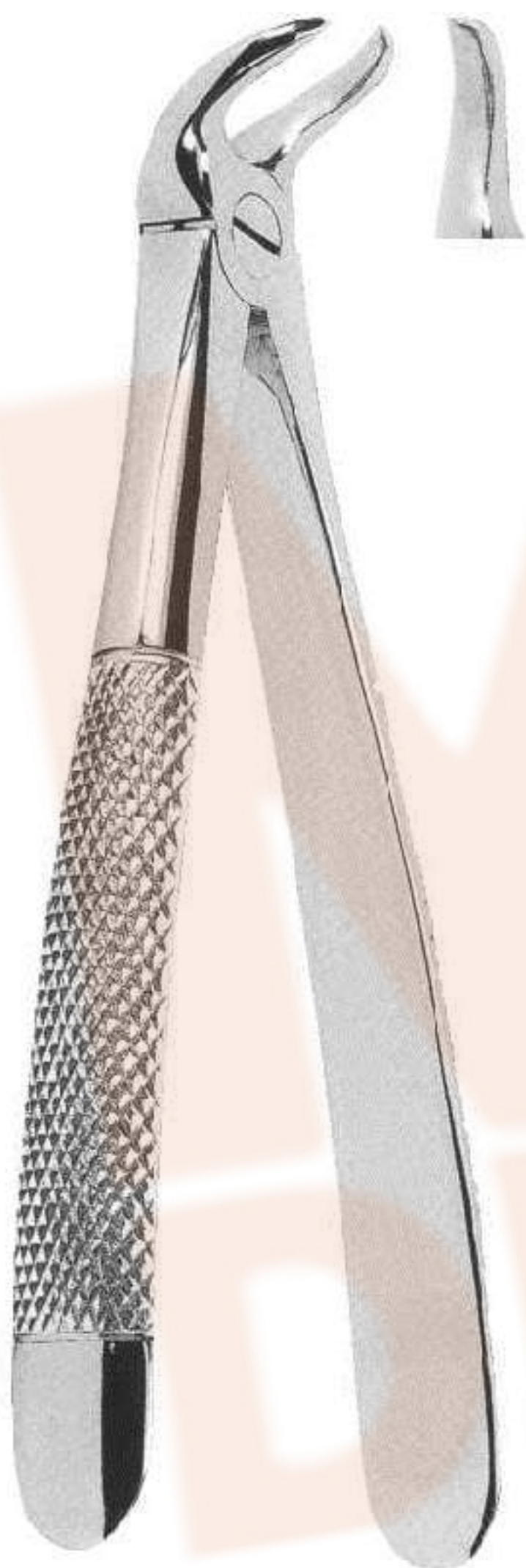

1074
Fig 87
Lower decayed molars
or broken-down crowns



WITH SERRATED
TIPS

1075
Fig 89
Upper molars, right



WITH SERRATED
TIPS

1076
Fig 90
Upper molars, left

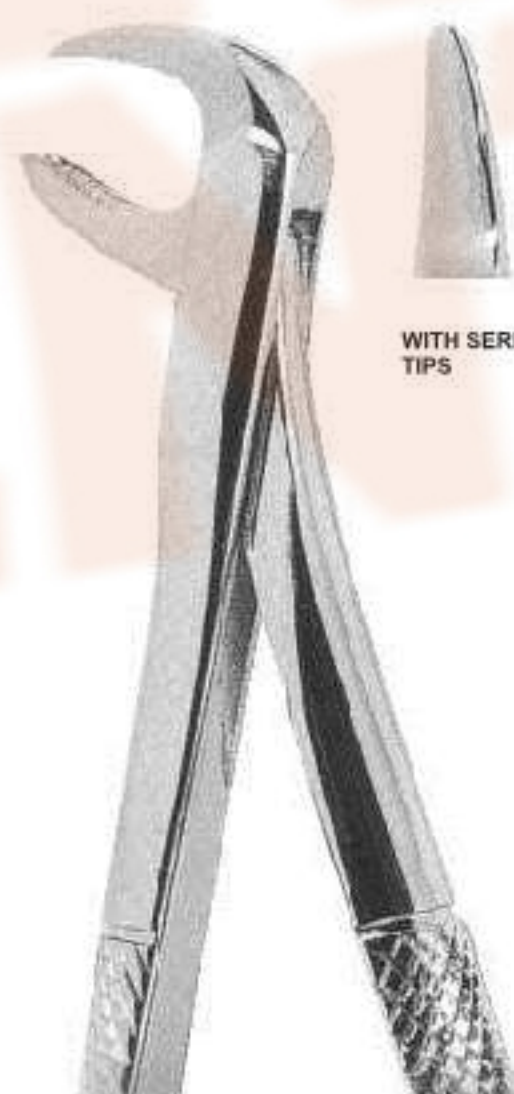

WITH SERRATED
TIPS

1077
Fig 99
Broken-down lower molars

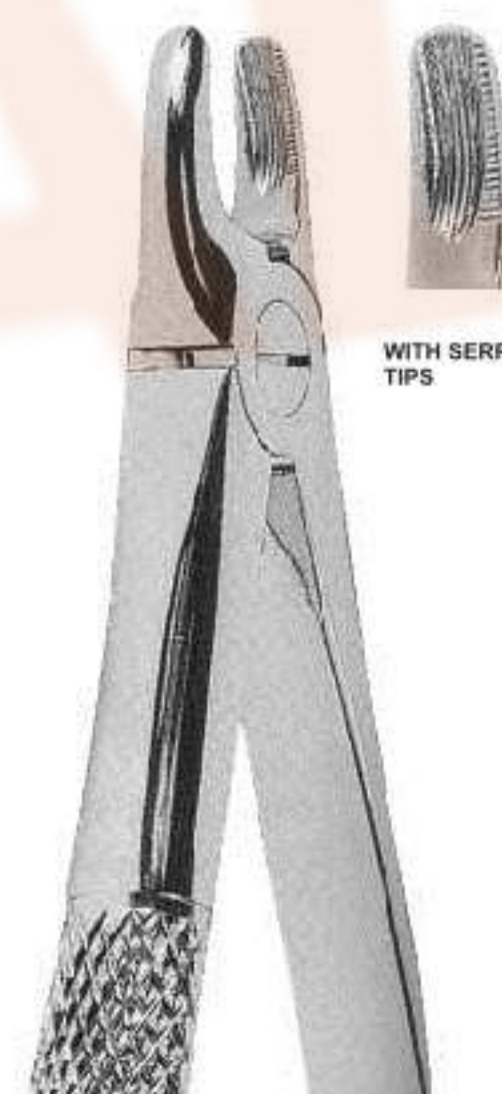

WITH SERRATED
TIPS

1078
Fig 107
Upper canines



Extracting Forceps - English Pattern

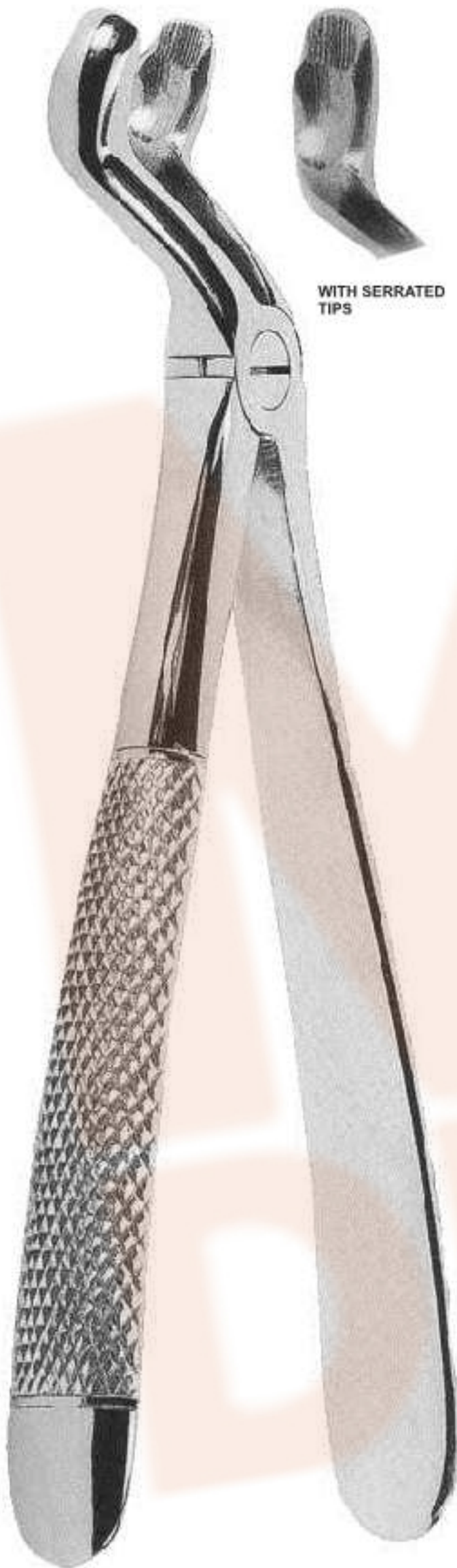

WITH SERRATED TIPS

1079
Fig 121
Upper third molars

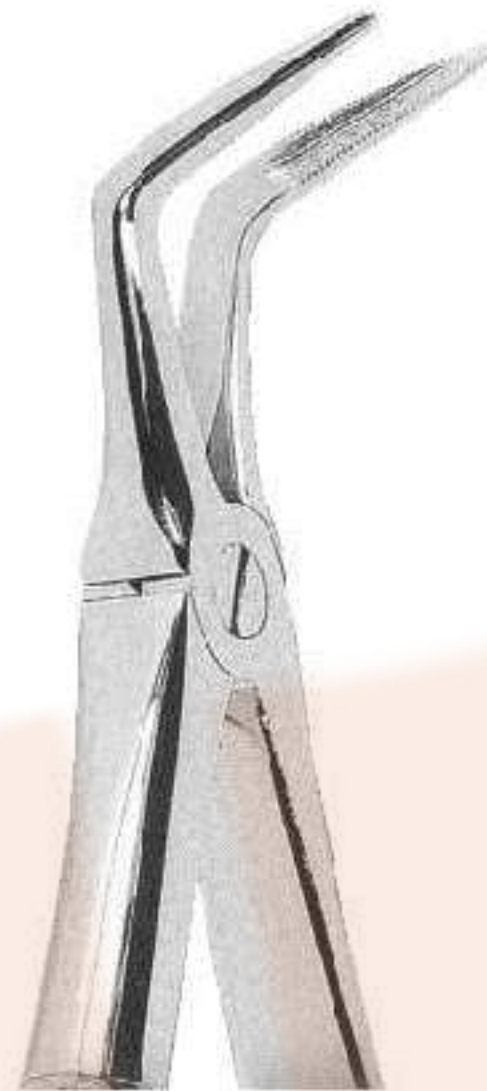

WITH SERRATED TIPS

1080
Fig 145
Lower roots



WITH SERRATED TIPS

1081
Fig 151½
Upper roots



WITH SERRATED TIPS

1082
Fig 166
Universal extracting forceps for upper teeth, in particular molars and premolars



WITH SERRATED TIPS

1083
Fig 167
Universal extracting forceps for lower teeth, in particular molars and premolars

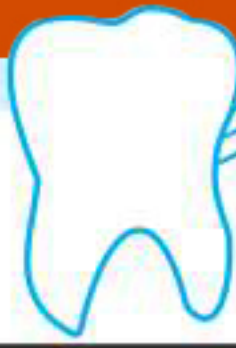

Extracting Forceps - English Pattern

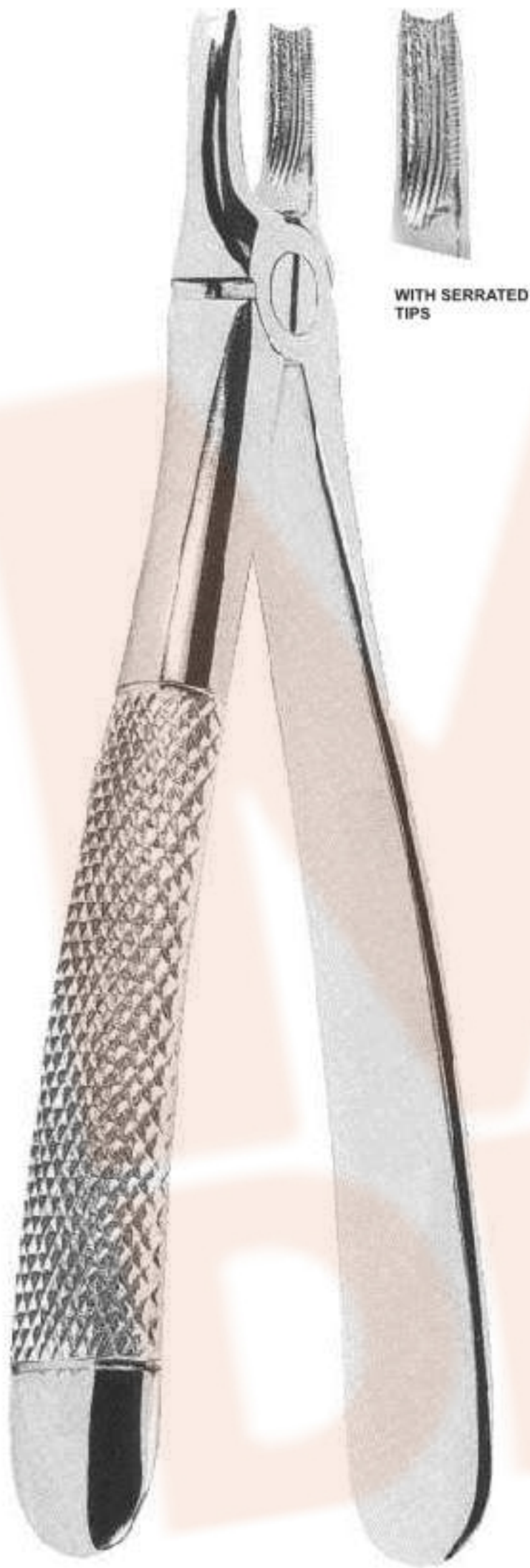

1084
Fig 168
Upper canines



WITH SERRATED TIPS

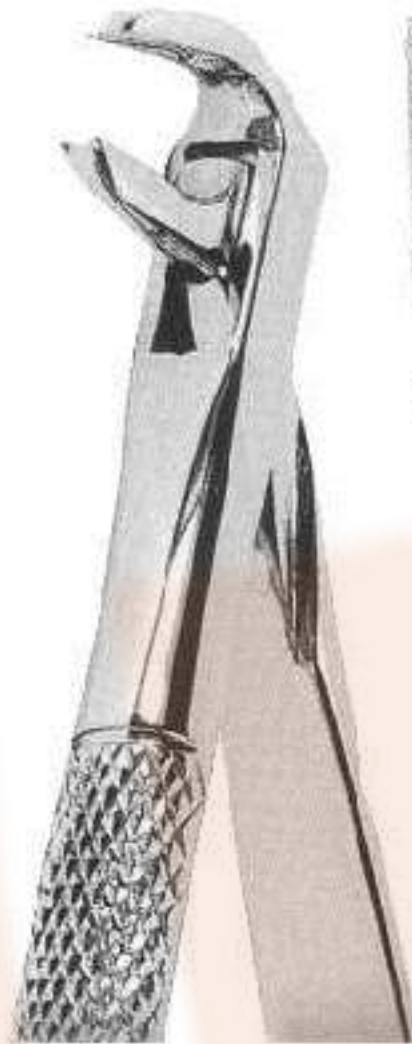

1085
Fig 169
Lower canines



WITH SERRATED TIPS

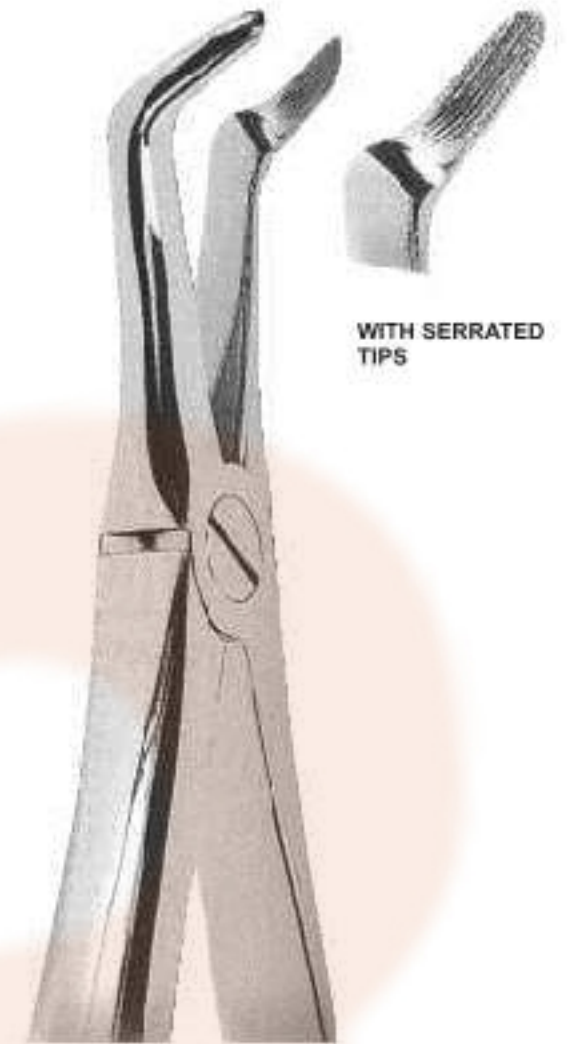

1086
Fig 346
Lower roots



WITH SERRATED TIPS



1087
Fig 349
Upper roots



WITH SERRATED TIPS



1088
Fig 359
Lower roots



WITH SERRATED TIPS



Extracting Forceps - Mead Pattern

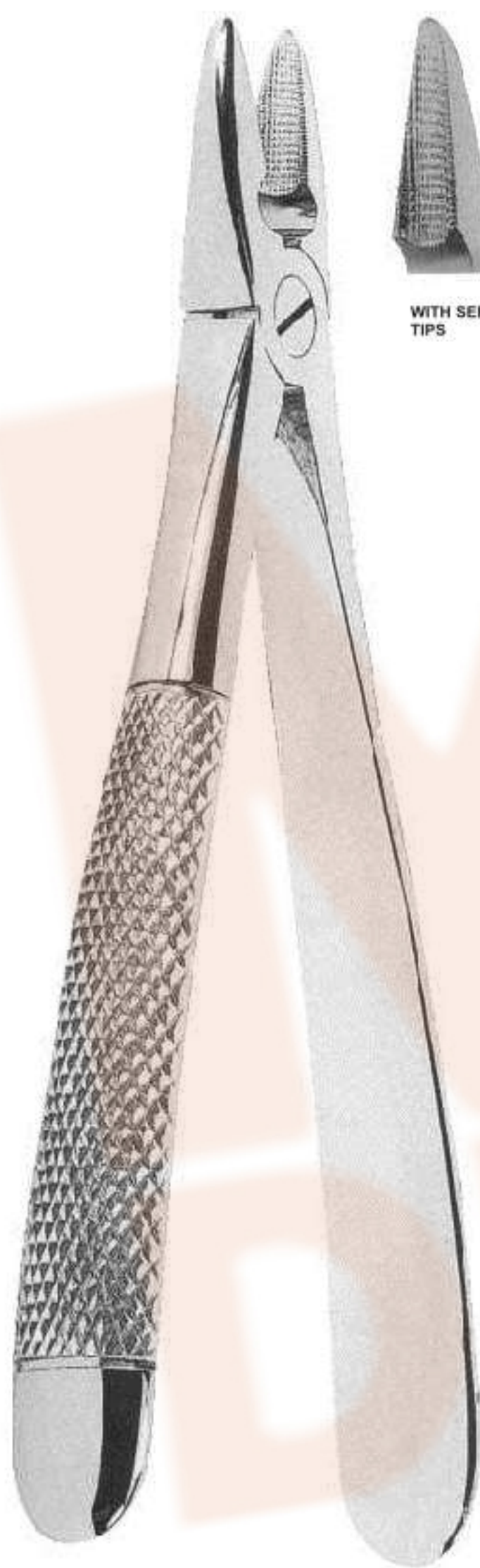

1089
Fig 1
Universal extracting forcep for
upper incisors and canines



WITH SERRATED
TIPS



1090
Fig 2
Upper molars



WITH SERRATED
TIPS

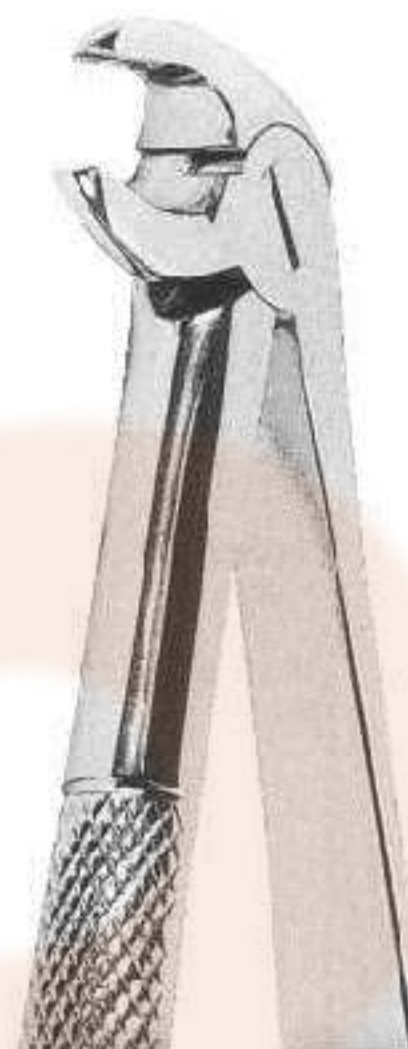

1091
Fig 3
Lower incisors, premolar
and roots



WITH SERRATED
TIPS



1092
Fig 4
Lower molars



WITH SERRATED
TIPS



Extracting Forceps With Anatomically Shaped Handle

MIR
DENTAL

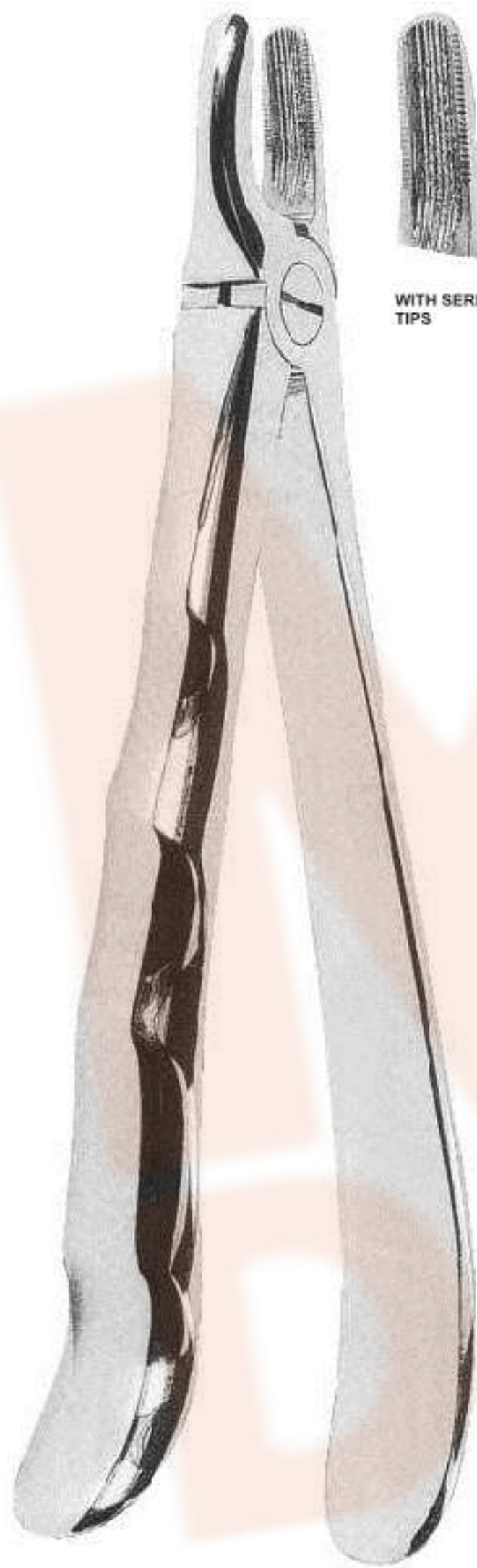

1093
Fig 1
Upper incisors
and canines



WITH SERRATED
TIPS



1094
Fig 2
Upper incisors
and canines



WITH SERRATED
TIPS

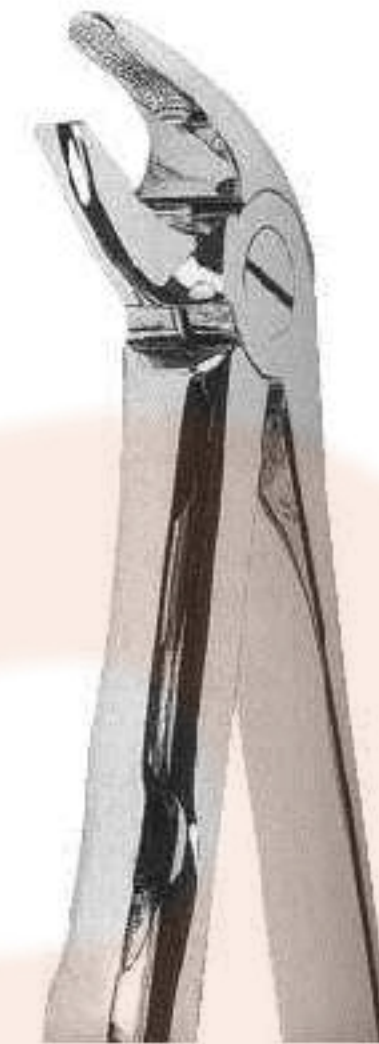

1095
Fig 4
Lower incisors
and canines



WITH SERRATED
TIPS



1096
Fig 7
Upper premolars



WITH SERRATED
TIPS

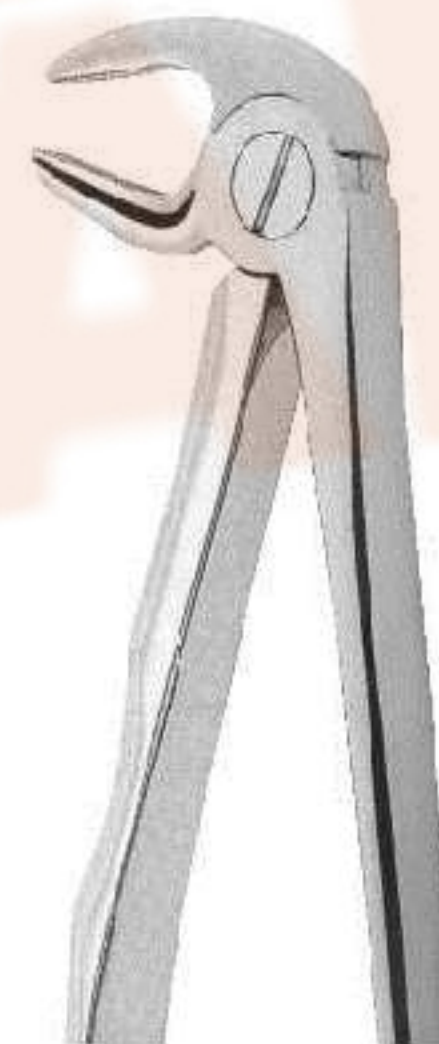

1097
Fig 13
Lower premolars



WITH SERRATED
TIPS



Extracting Forceps With Anatomically Shaped Handle



1098
Fig 17
Upper molars, right

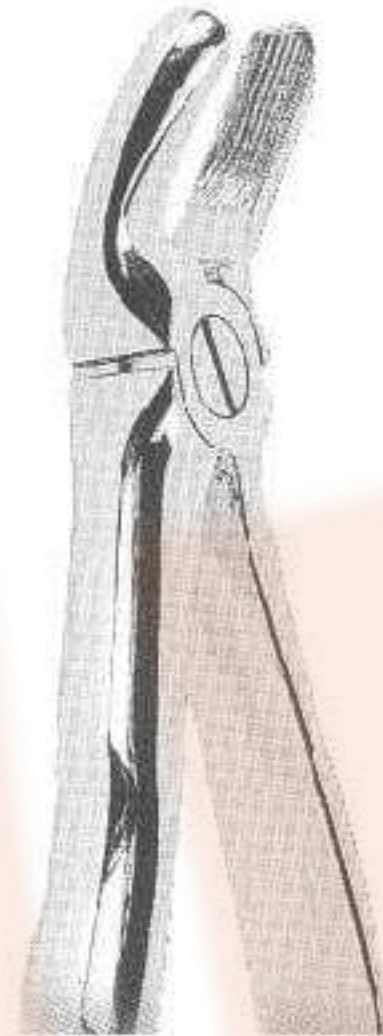

1099
Fig 18
Upper molars, left



WITH SERRATED
TIPS

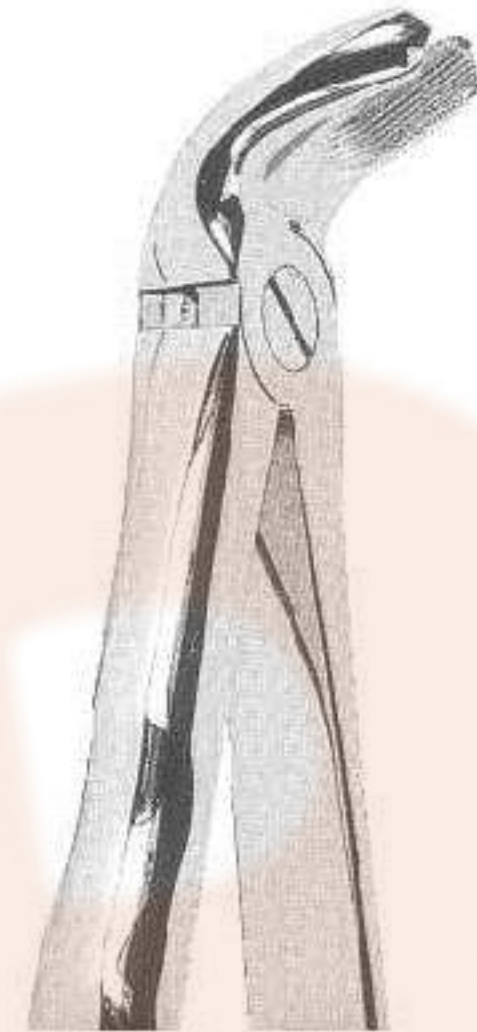

1100
Fig 21
Lower molars



WITH SERRATED
TIPS



1101
Fig 22
Lower molars



WITH SERRATED
TIPS

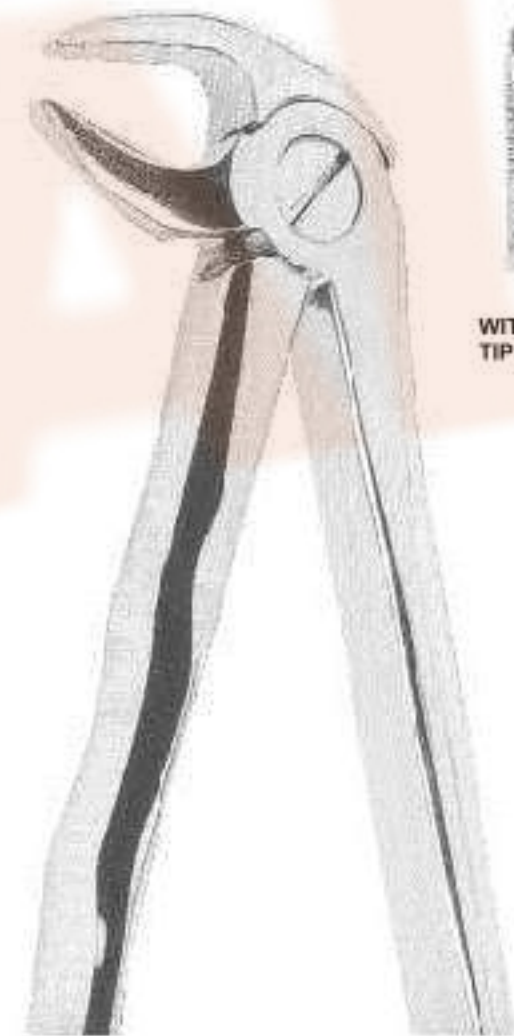

1102
Fig 33
Lower roots



WITH SERRATED
TIPS

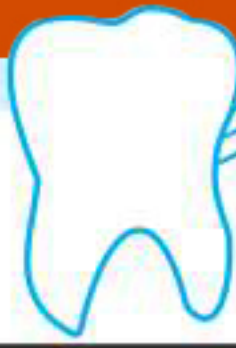

Extracting Forceps With Anatomically Shaped Handle

MIR
DENTAL



1110
Fig 89
Upper molars, right



WITH SERRATED TIPS



1111
Fig 90
Upper molars, left



WITH SERRATED TIPS

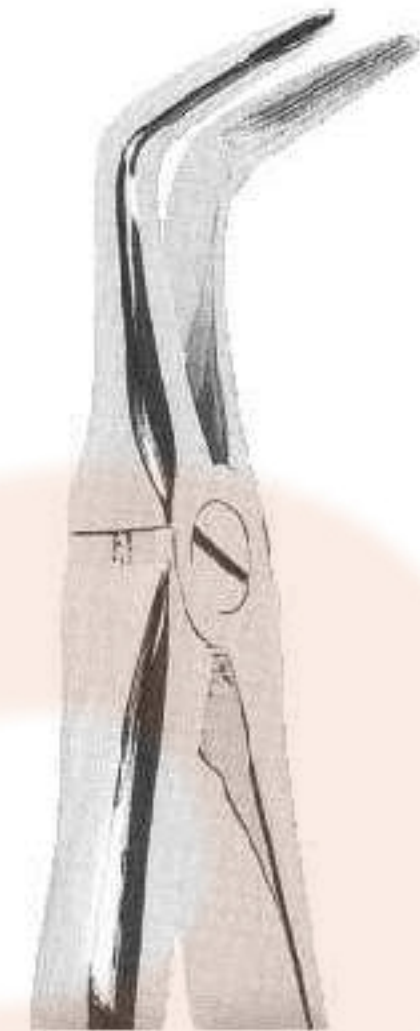

1112
Fig 145
Lower roots



WITH SERRATED TIPS



1113
Fig 151 1/2
Upper roots



WITH SERRATED TIPS



1114
Fig 349
Upper roots



WITH SERRATED TIPS

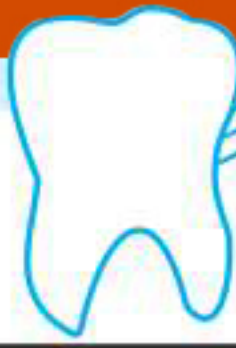

Extracting Forceps With Anatomically Shaped Handle



1103
Fig 45
Lower roots



WITH SERRATED TIPS

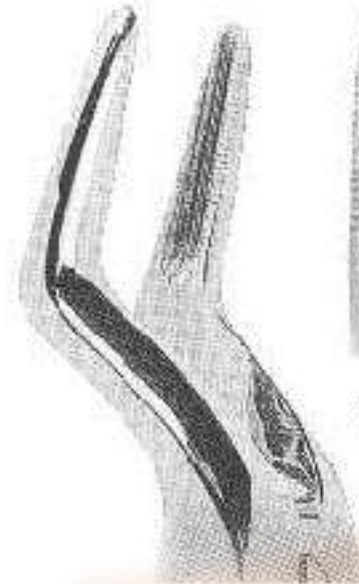

1104
Fig 51 A
Upper roots



WITH SERRATED TIPS



1105
Fig 67 A
Upper third molars



WITH SERRATED TIPS



1106
Fig 74
Lower roots



WITH SERRATED TIPS



1107
Fig 79
Lower third molars



WITH SERRATED TIPS



1108
Fig 86 C
Lower molars



WITH SERRATED TIPS

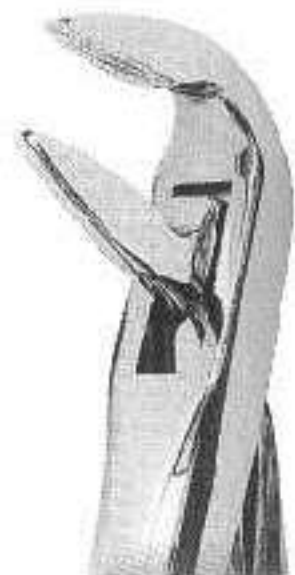

1109
Fig 359
Lower roots



WITH SERRATED TIPS

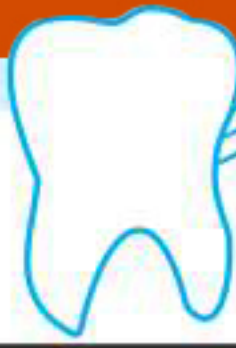

Extracting Forceps - American Pattern

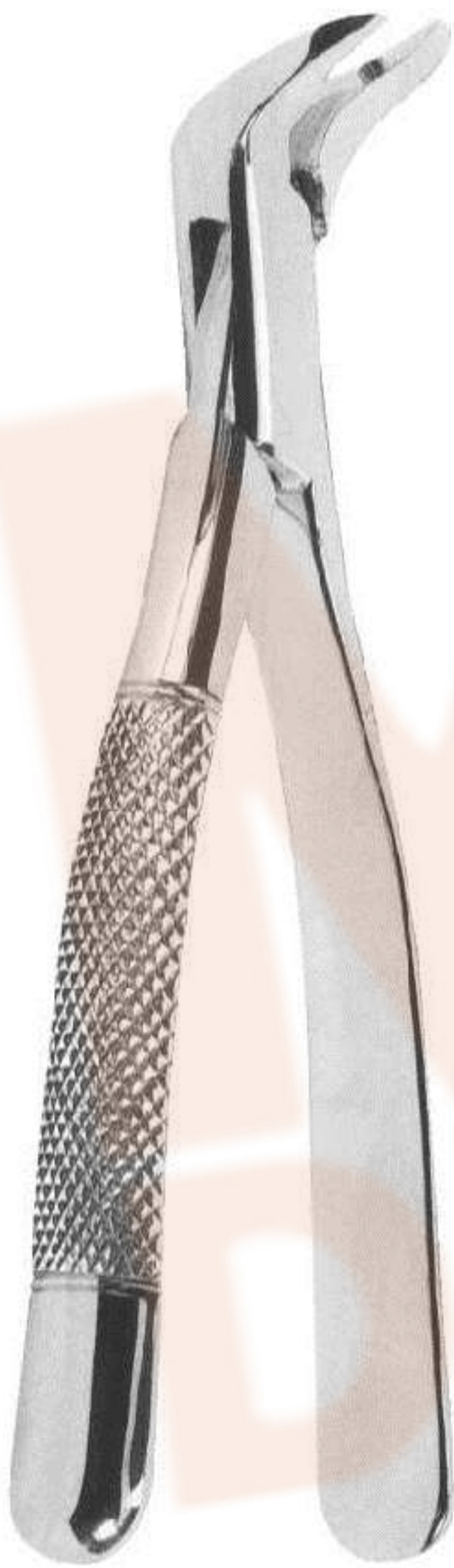

1115
Fig 5
Lower third molars

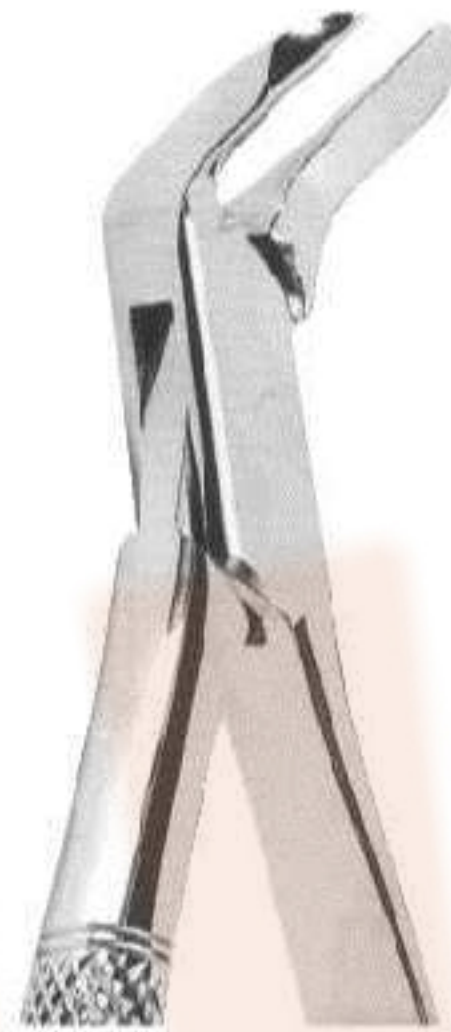

1116
Fig 6
Separating forcep



1117
Fig 105
Upper molars

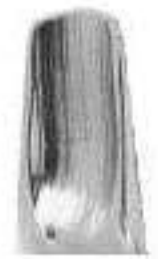

1118
Fig 16
Lower molars

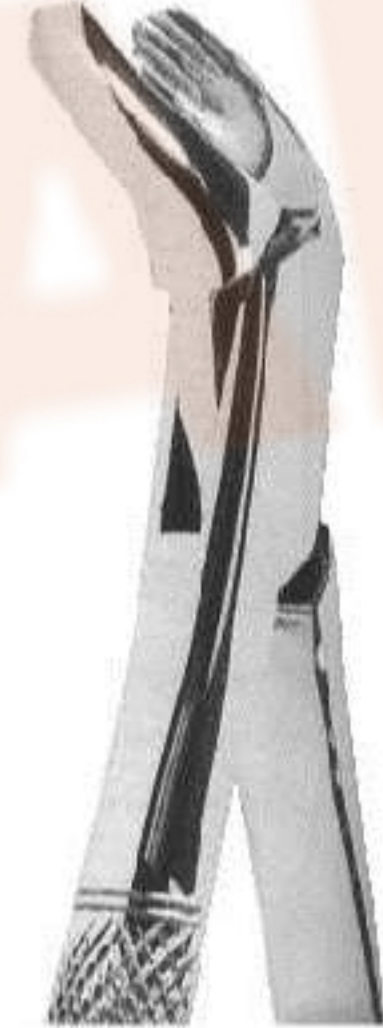

1119
Fig 17
Lower molars



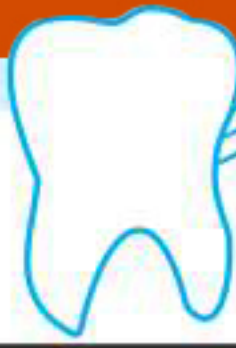

Extracting Forceps - American Pattern

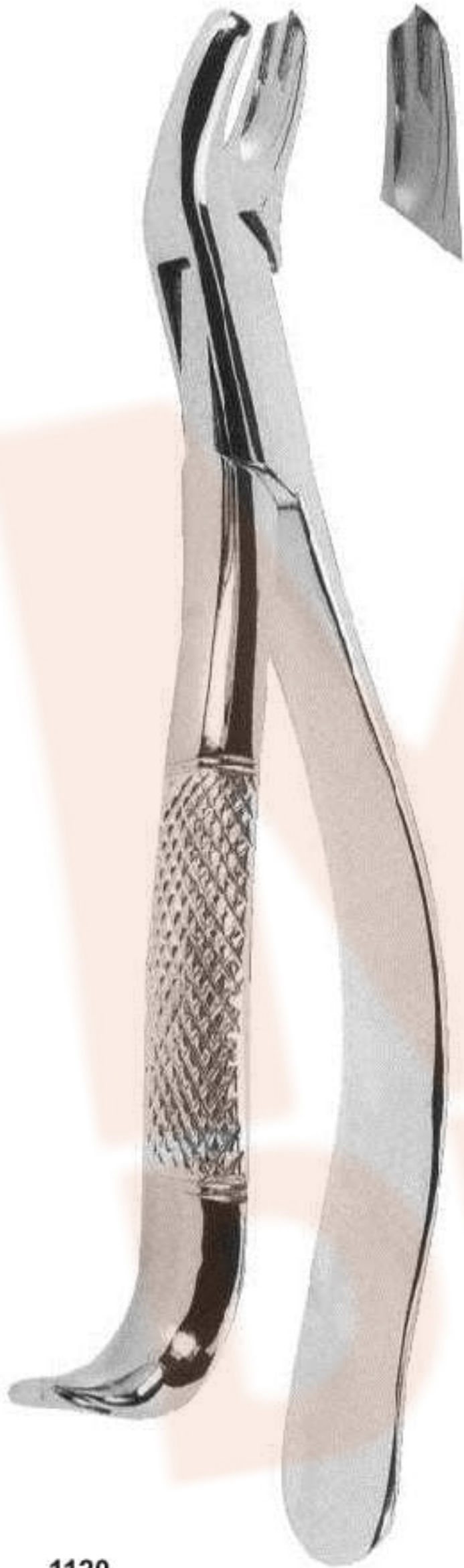

1120
Fig 18 L
Upper molars, left

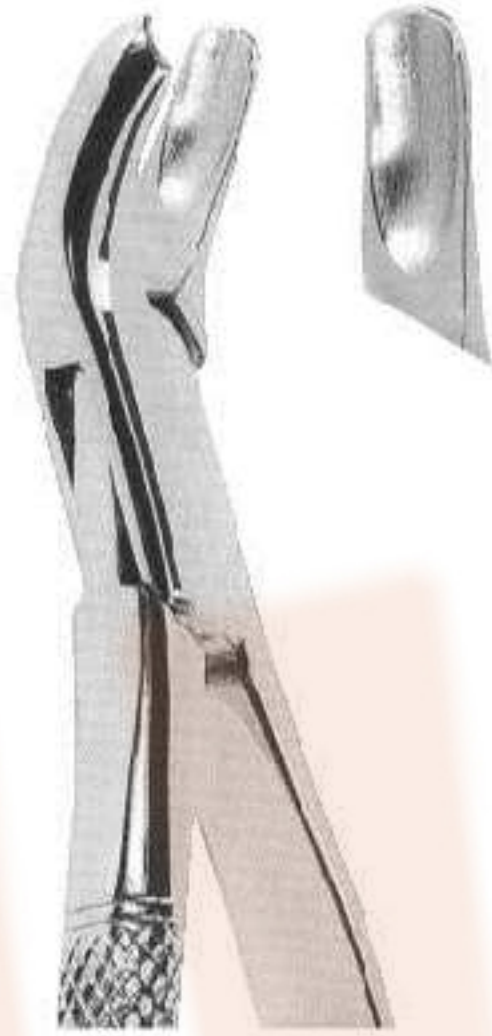

1121
Fig 18 R
Upper molars, right



1122
Fig 23
Lower molars



1123
Fig 53 R
Upper molars, right



1124
Fig 53 L
Upper molars, left

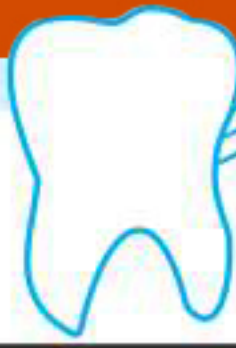

Extracting Forceps - American Pattern

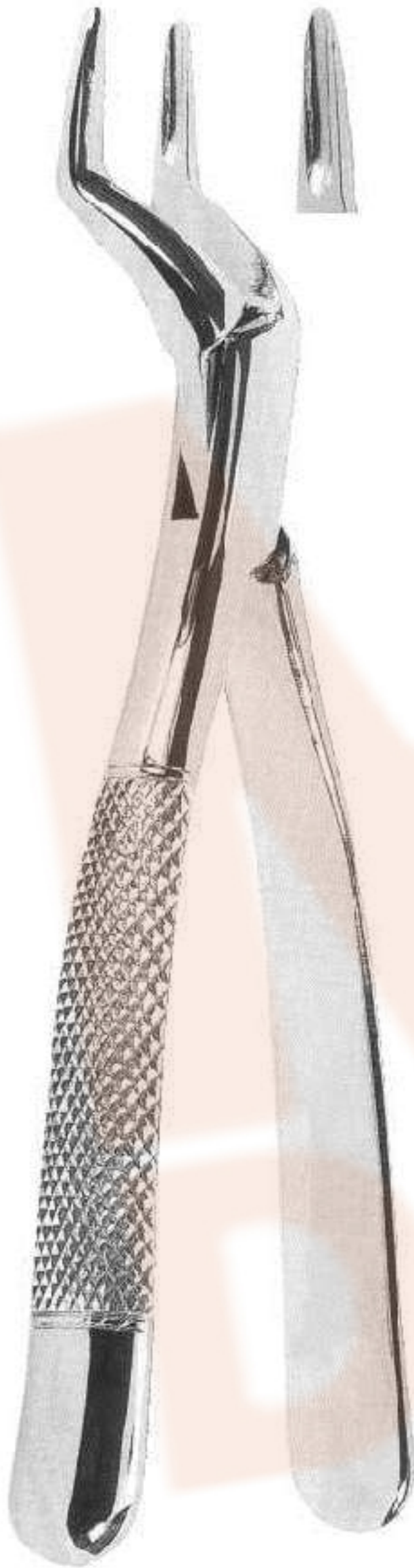

1125
Fig 65
Upper incisors and roots



1126
Fig 69
Upper and lower roots

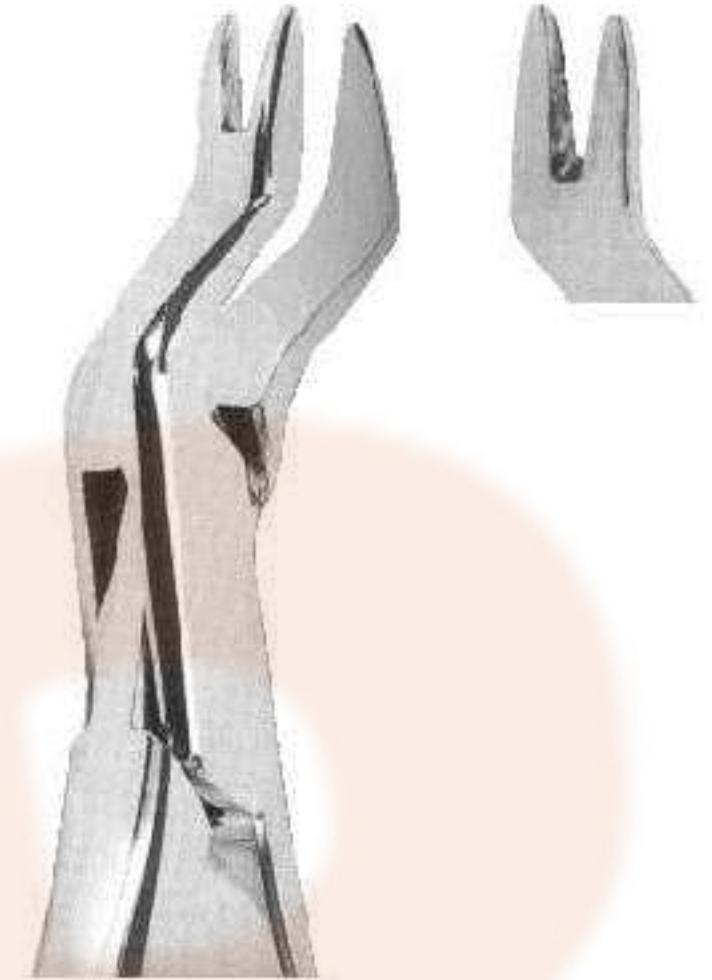

1127
Fig 88 R
Upper molars, right

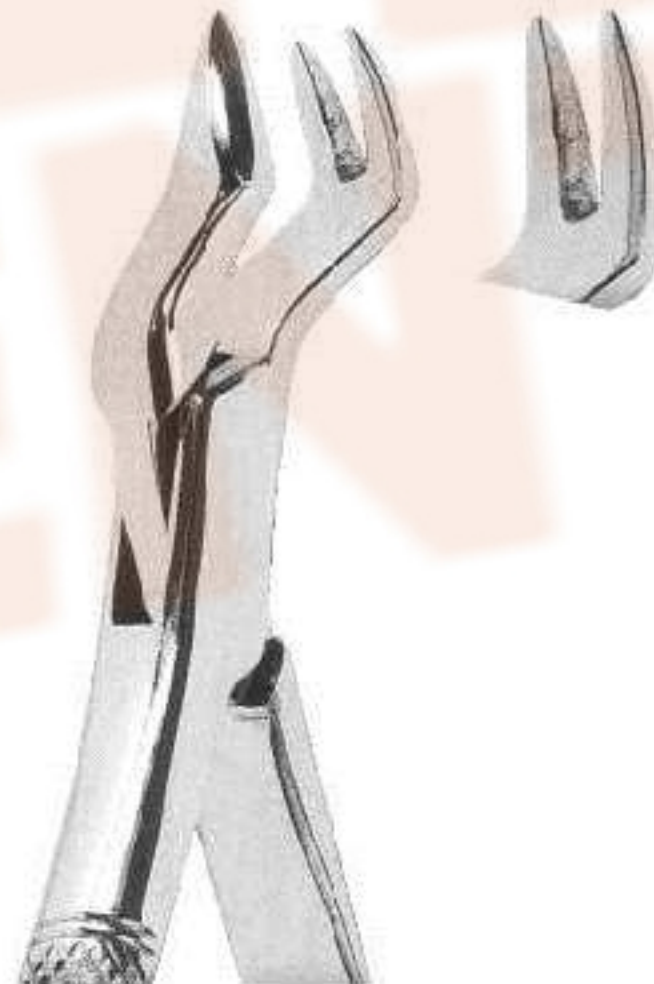

1128
Fig 88 L
Upper molars, left

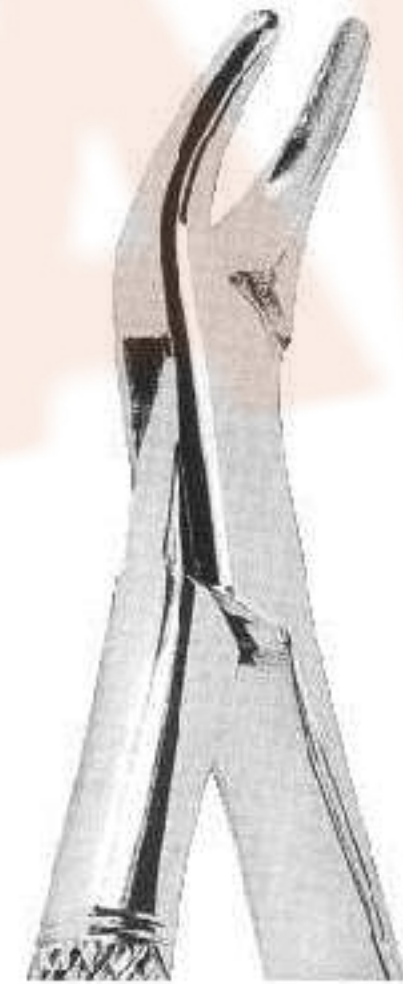

1129
Fig 101
Deciduous teeth



Extracting Forceps - American Pattern

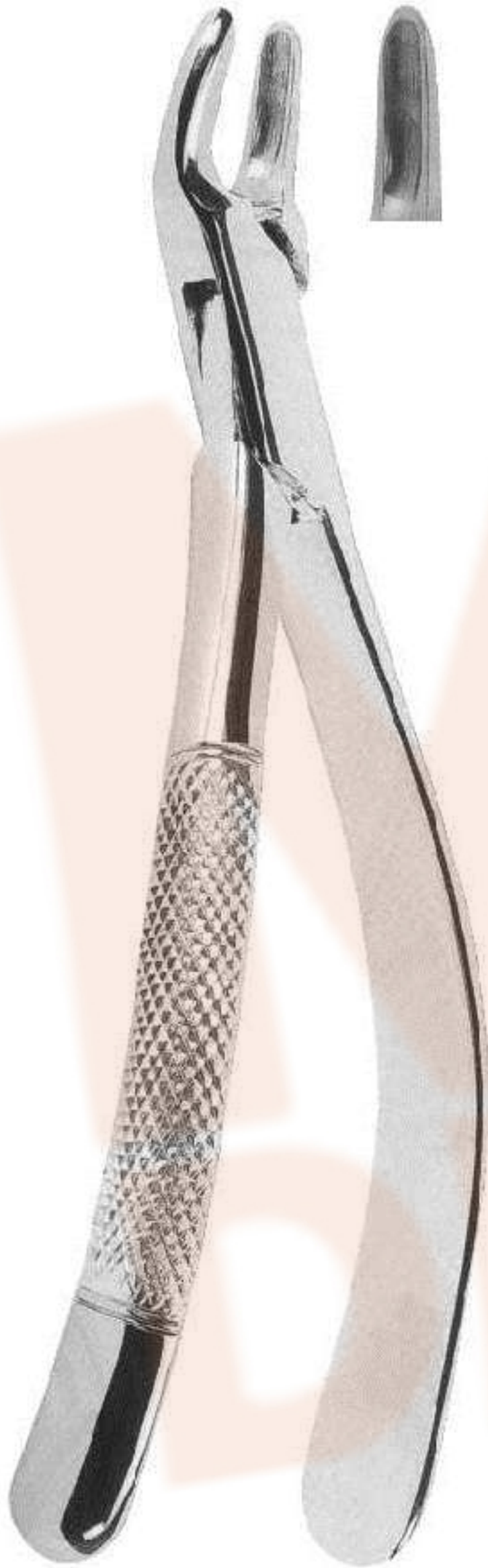

1130
Fig 150
Upper incisors, premolars, roots

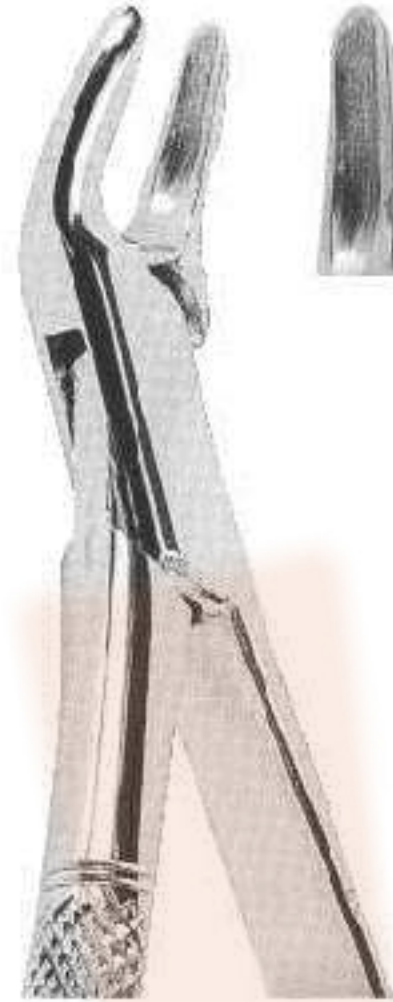

1131
Fig 150 S
Upper teeth (for children)

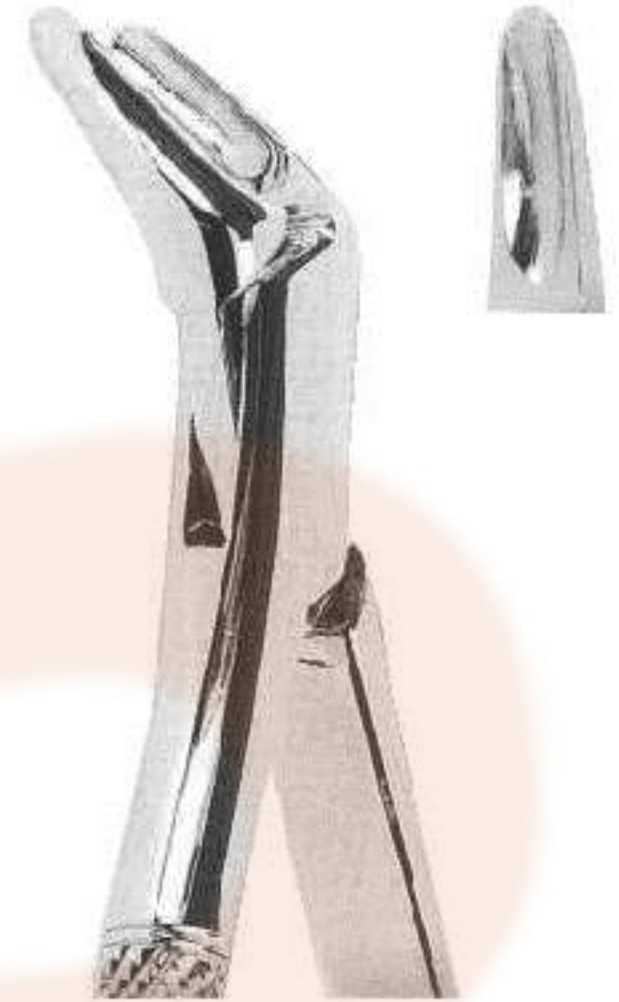

1132
Fig 151
Upper incisors, premolars, roots



1133
Fig 151S
Lower teeth (for children)

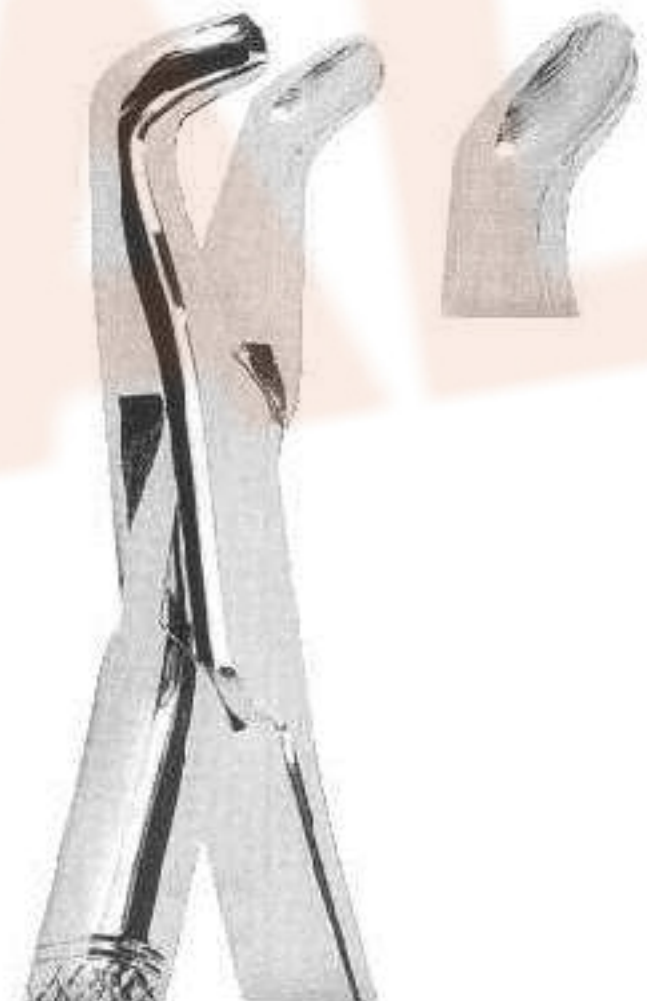

1134
Fig 222
Lower third molars

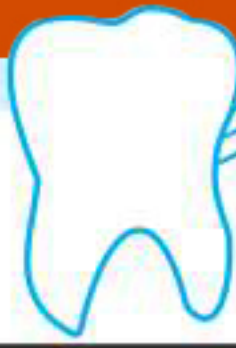

Extracting Forceps - American Pattern

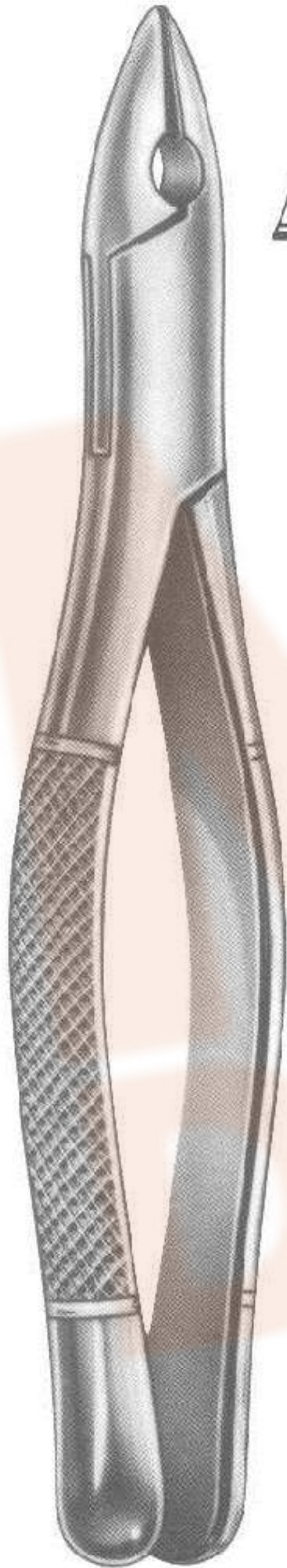

1135
Fig 1
upper incisors and bicuspid

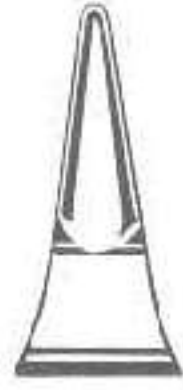

1136
Fig 1 B
upper roots, anterior

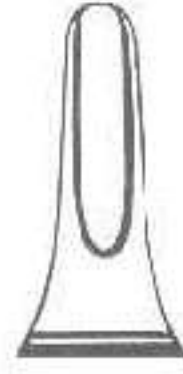

Physick
1137
Fig 5
lower wisdoms

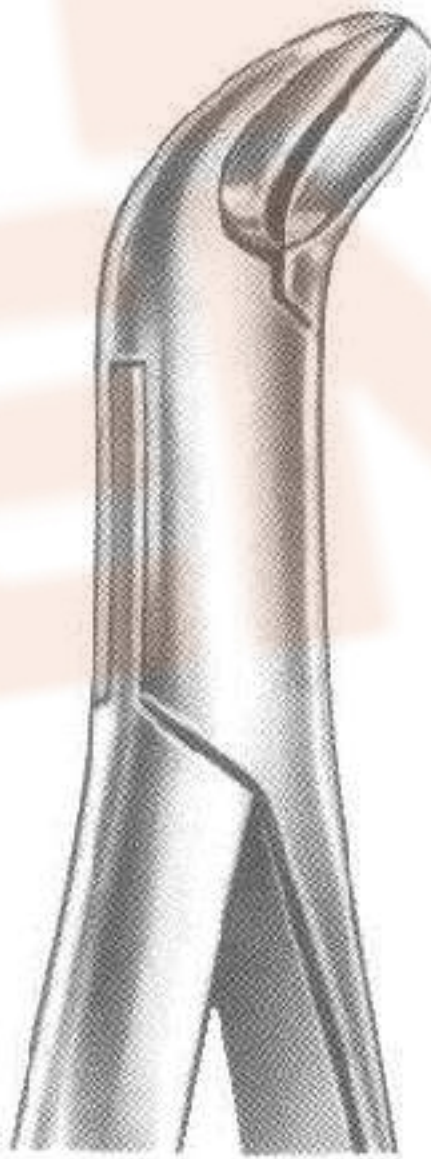
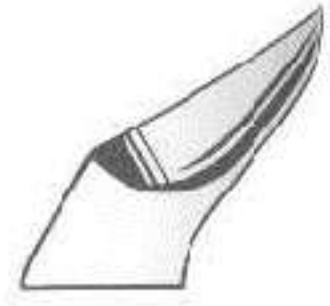

1138
Fig 6
lower molars, splitting forceps

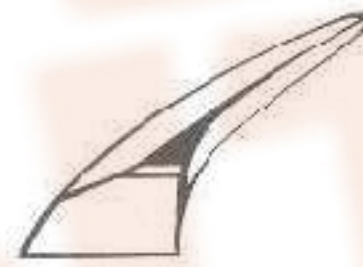

1139
Fig 10 H
upper molars

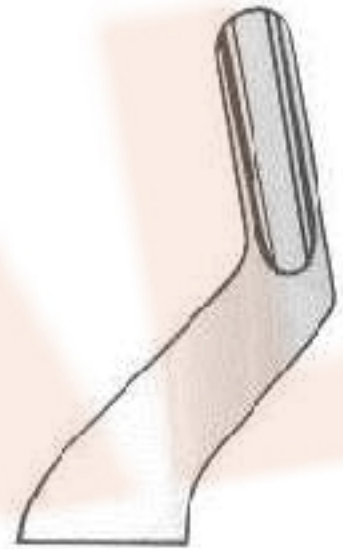

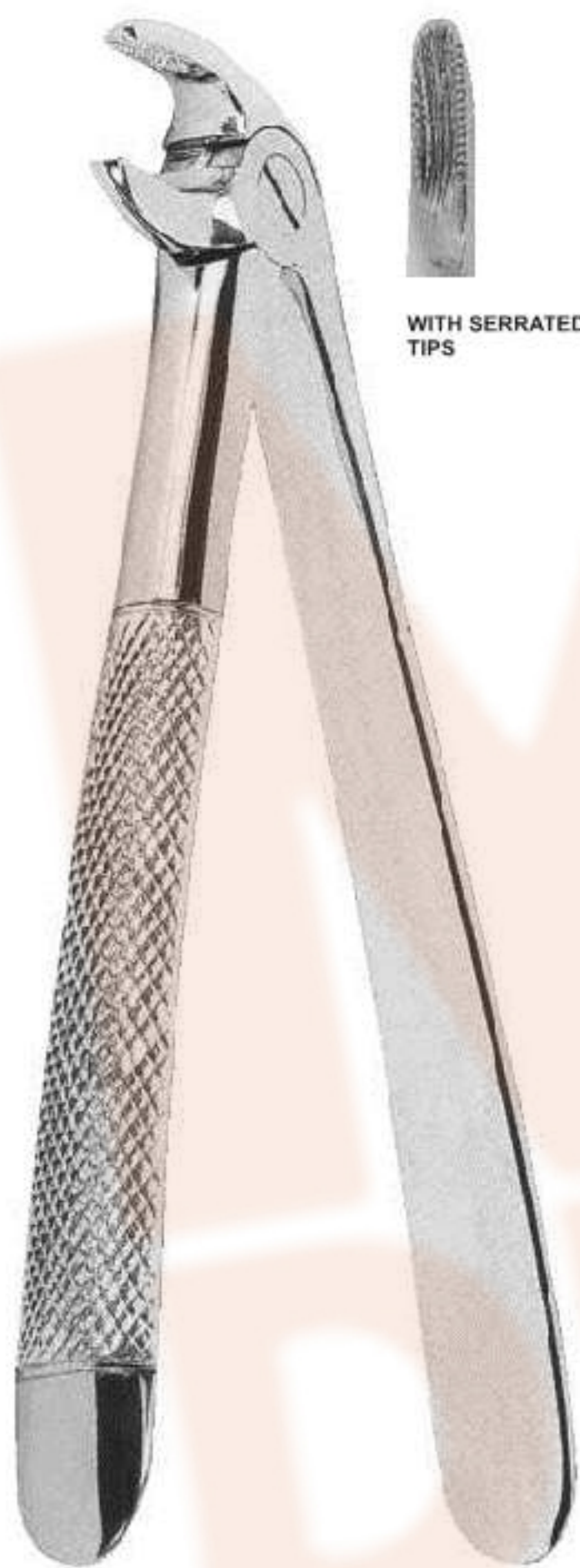

1140
Fig 135
Lower premolars



WITH SERRATED
TIPS

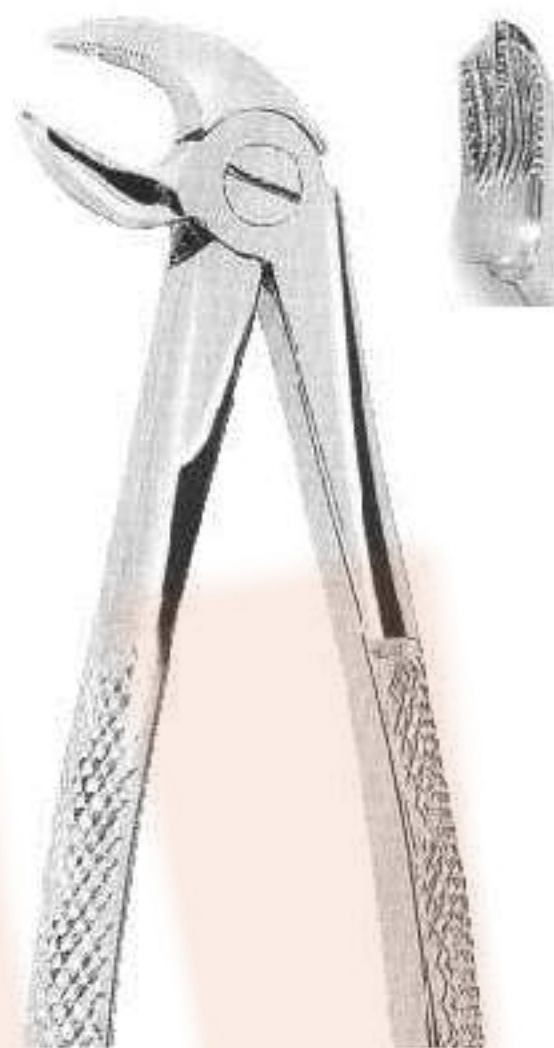

1141
Fig 225
Lower molars

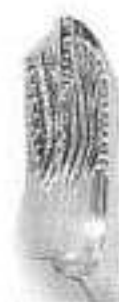

1142
Fig 305
Upper incisors
and roots



1143
Fig 33 S
Lower roots



WITH SERRATED
TIPS



1144
Fig 38
Lower incisors
and canines



WITH SERRATED
TIPS

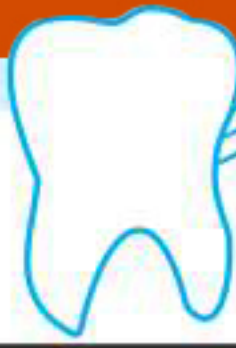

Extracting Forceps For Children - Klein Pattern

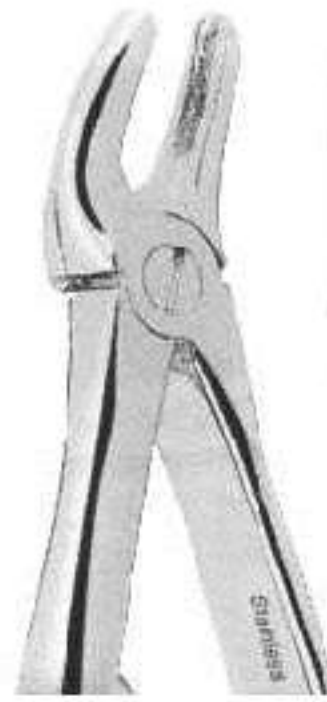

WITH SERRATED TIPS

1146
Fig 2
Upper premolars



WITH SERRATED TIPS

1147
Fig 3
Upper molars

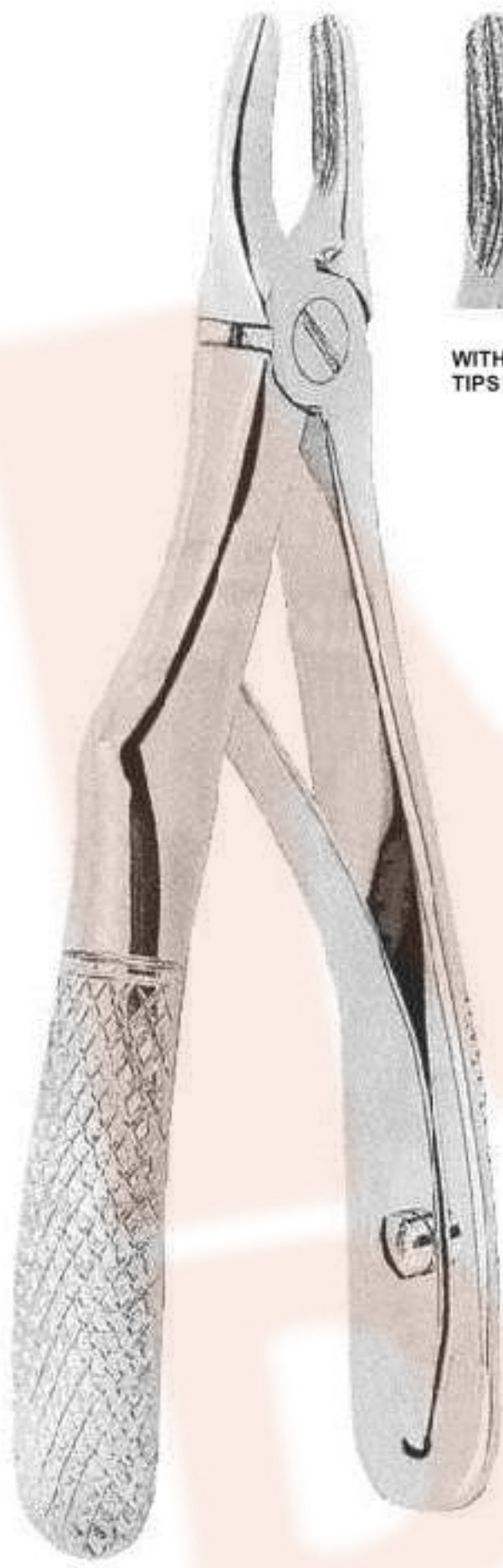

WITH SERRATED TIPS

1145
Fig 1
Upper incisors



WITH SERRATED TIPS

1148
Fig 4
Upper roots



WITH SERRATED TIPS

1149
Fig 5
Lower incisors

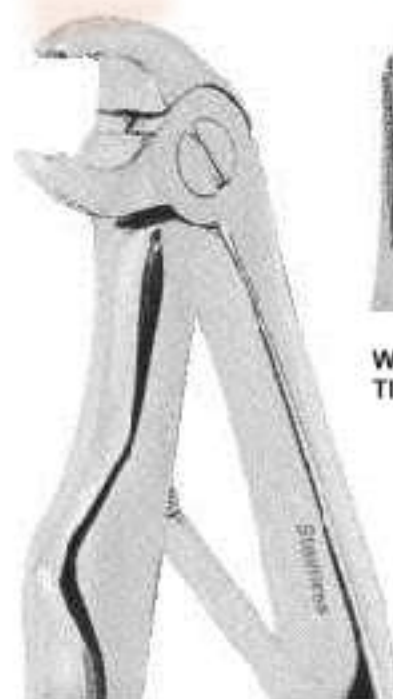

WITH SERRATED TIPS

1150
Fig 6
Lower molars



WITH SERRATED TIPS

1151
Fig 7
Lower roots

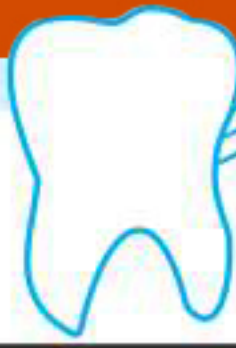

Root Splinter Extracting Forceps

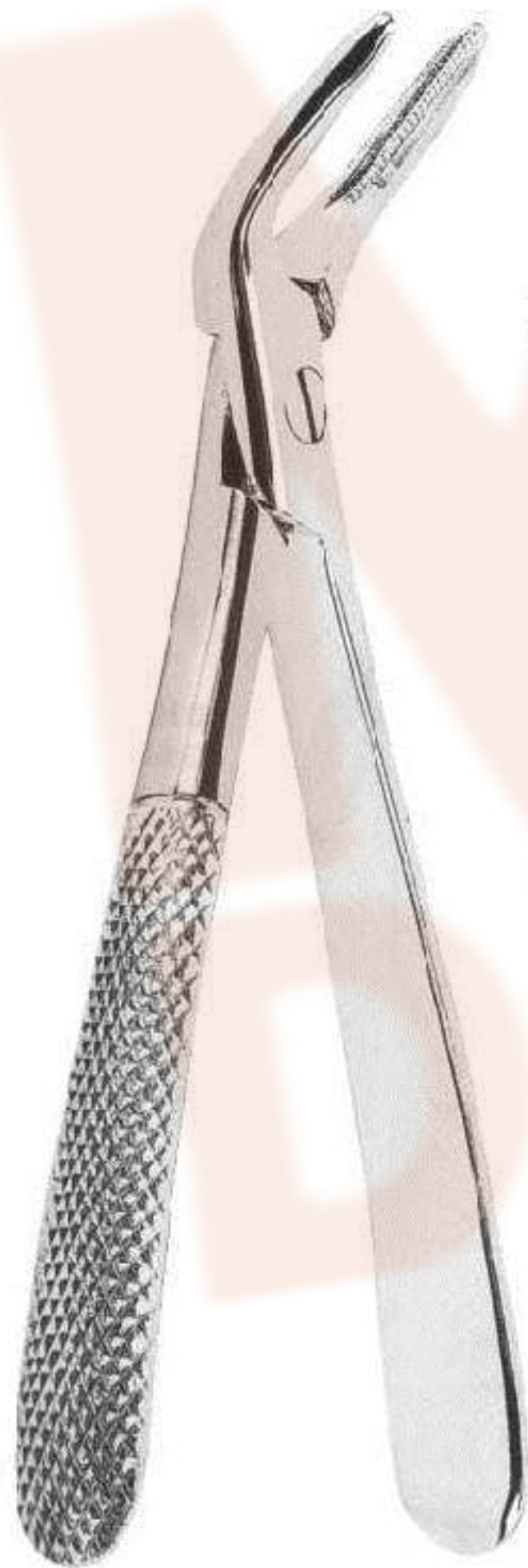

1152
Fig 1
Lower roots



1153
Fig 2
Upper roots

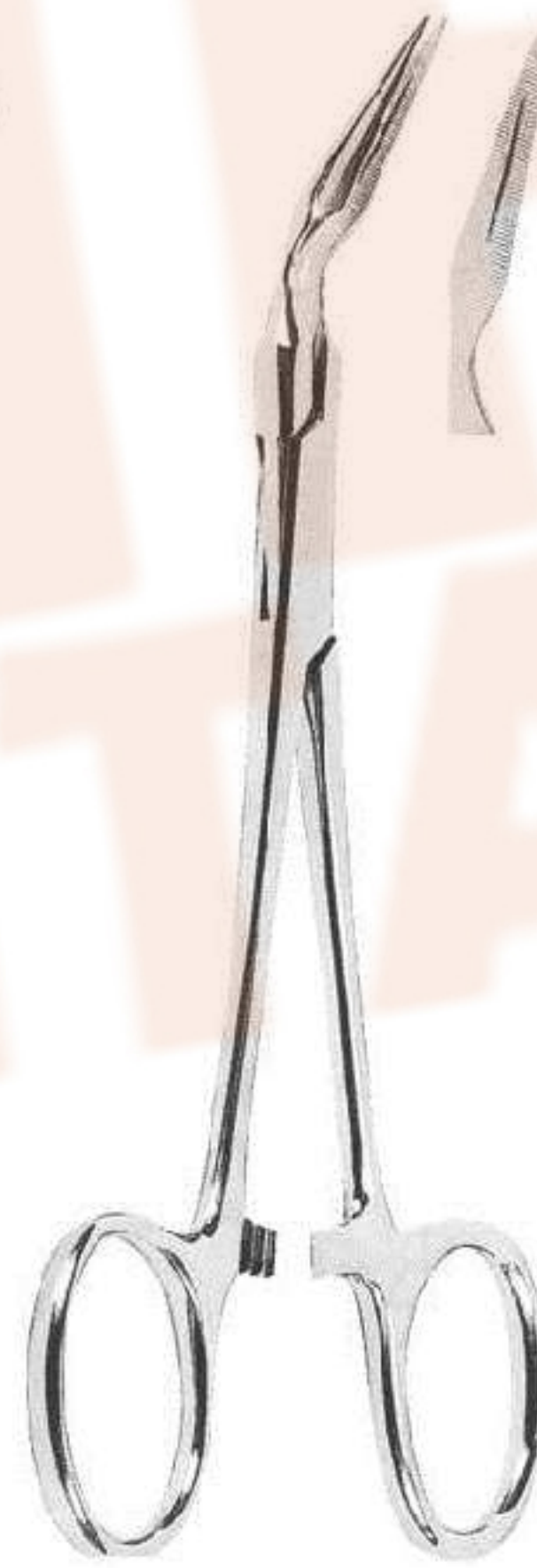

1155
Fig 2
Roots fragments

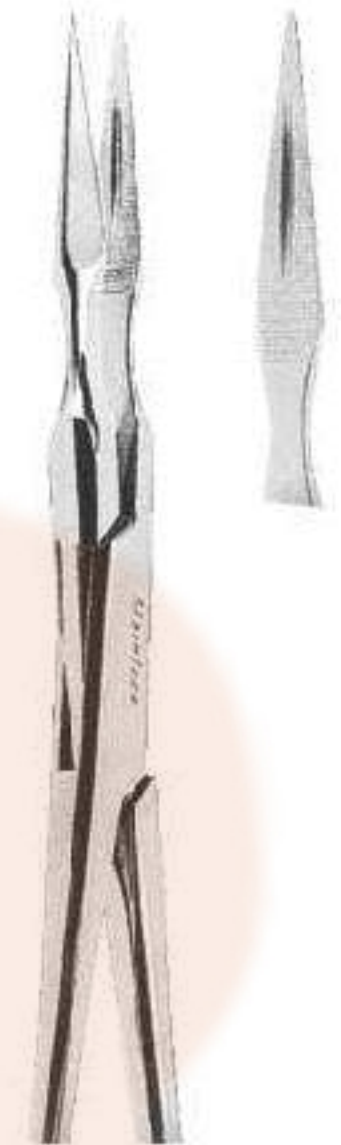

1154
Fig 1
Roots fragments



Root Elevators

lower jaw, left side

lower jaw, right side

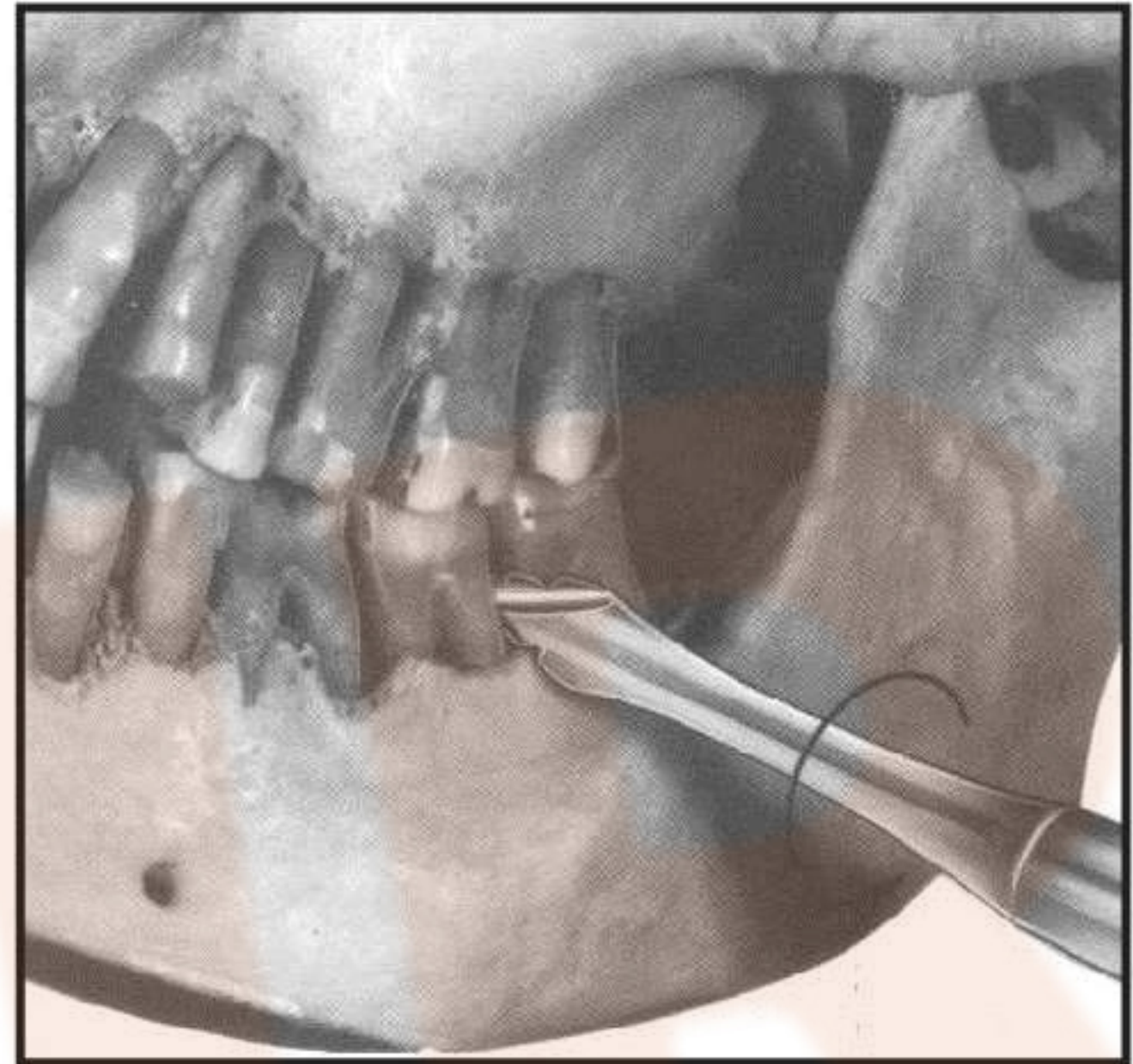

1200

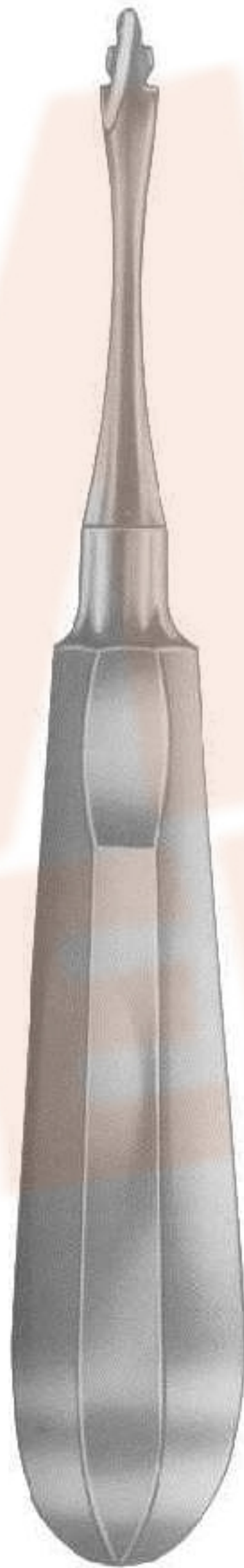

1201

Root elevator, spiral-shaped, for extremely facilitated extraction of the molars in the lower jaw. The slender, conical points allow deep penetration between tooth and gum. Owing to the hook-shaped working parts, slipping of the elevator is avoided.

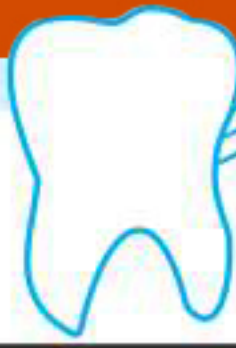

Root Elevators

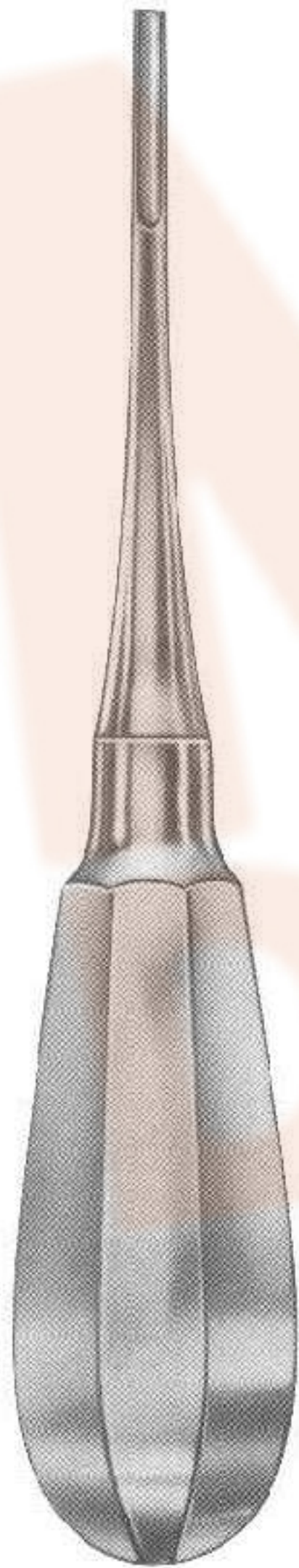

Bein



Bein
1202
Fig 1

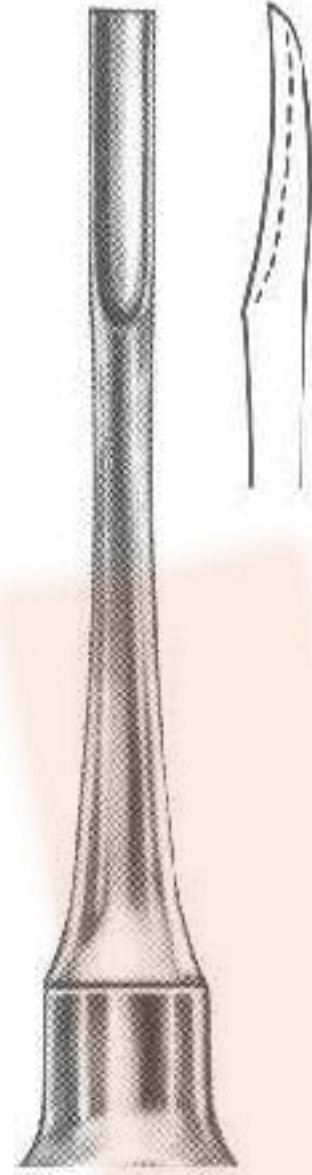

Bein
1203
Fig 2

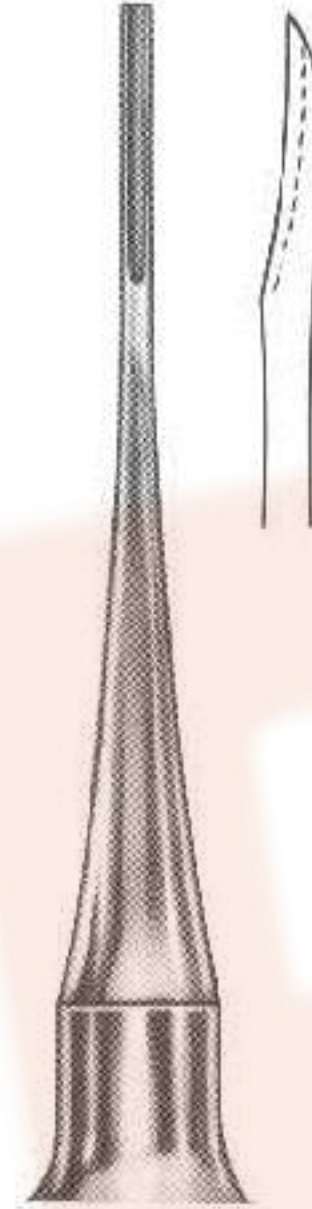

Bein
1204
Fig 0

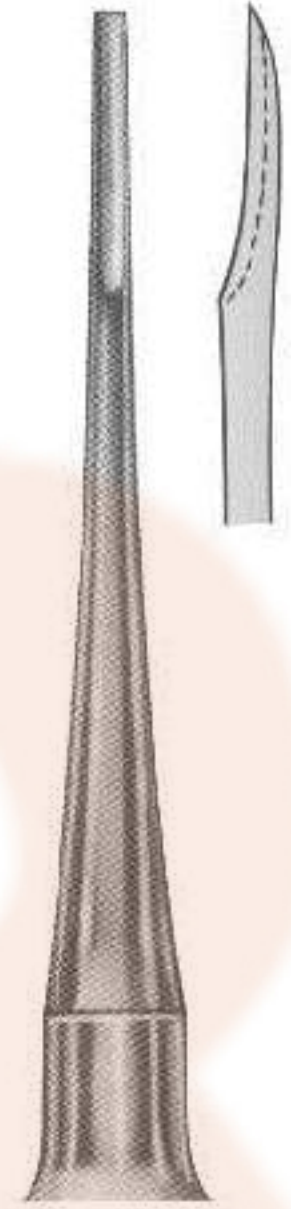

Bein
1205
Fig 3

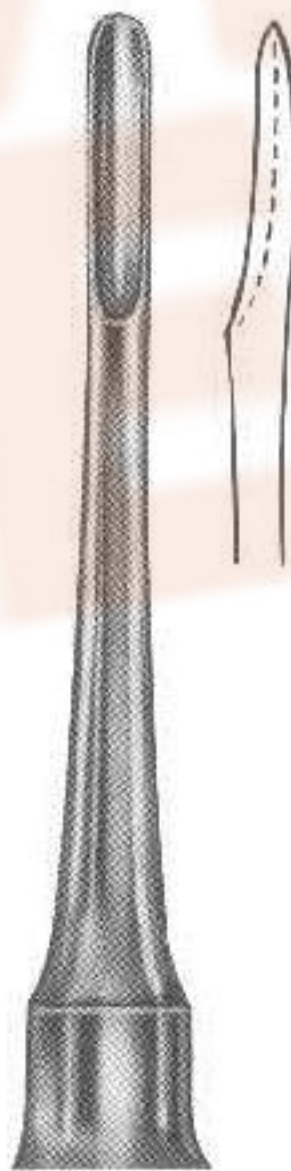

Bein
1206
Fig 4



Bein
1207
Fig 5



Bein
1208
Fig 6



Root Elevators

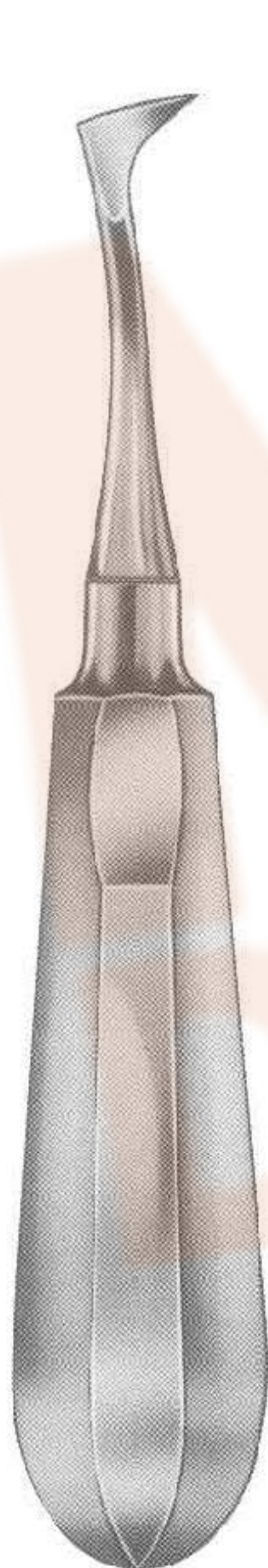

Seldin



Seldin
1209
Fig 1L



Seldin
1210
Fig 1R



Seldin
1211
Fig 2

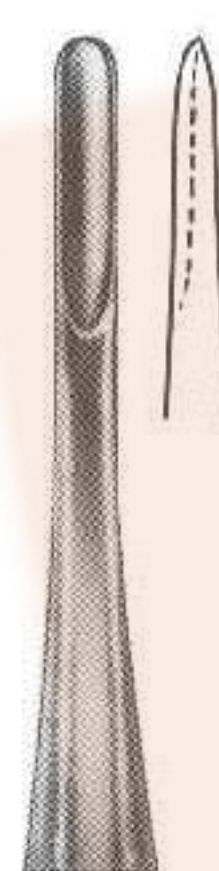

Seldin
1212
Fig 3



Seldin
1213
Fig 4L



Seldin
1214
Fig 4R



Root Elevators



**Cryer
1215
Fig 3**



**Cryer
1216
Fig 4**

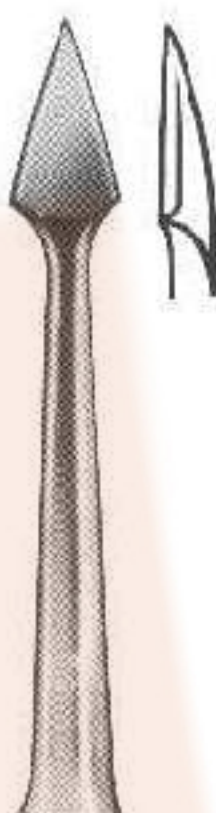

**Cryer
1217
Fig 12**



**Cryer
1218
Fig 27**



**Cryer
1219
Fig 28**



**Cryer
1220
Fig 27 S**

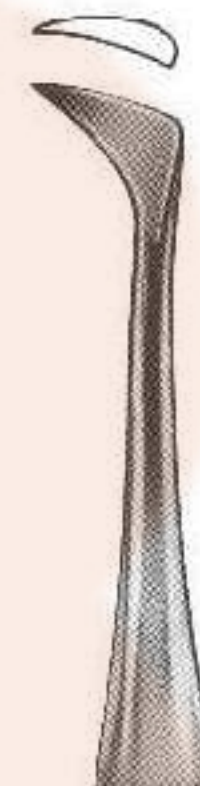

**Cryer
1221
Fig 28 S**



Root Elevators



Apical



Apical
1222
Fig 1



Apical
1223
Fig 2



Apical
1224
Fig 3



Apical
1225
Fig 4



Root Elevators



Cryer



Cryer
1226
Fig 1



Cryer
1227
Fig 2

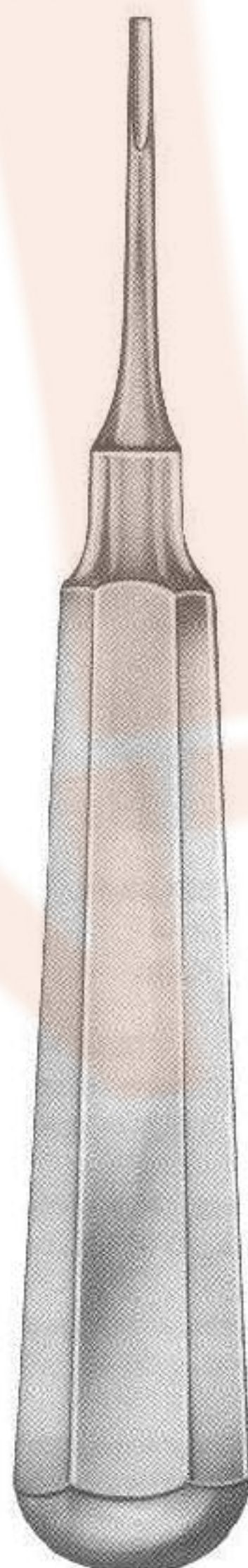

Coupland



Coupland
1228
Fig 1



Coupland
1229
Fig 2



Coupland
1230
Fig 3



Root Elevators

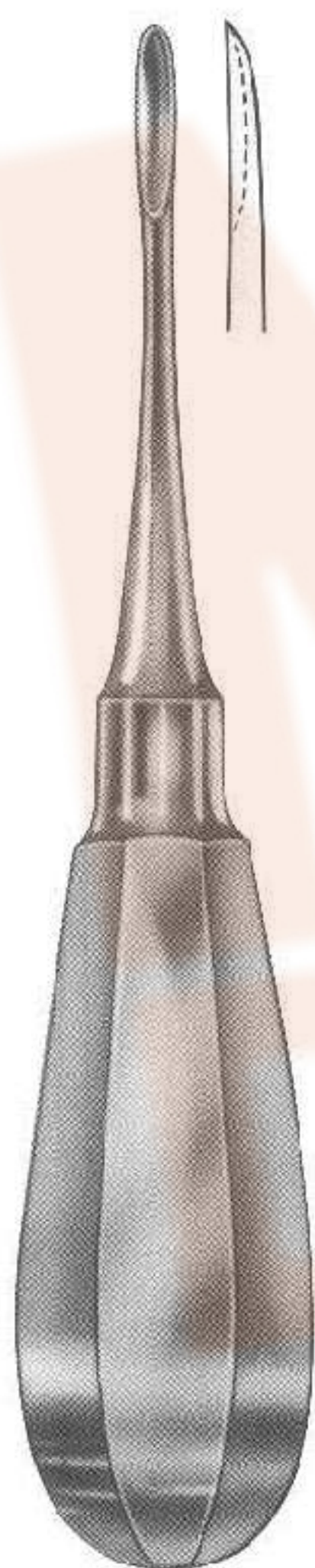

1231
Fig 1



1232
Fig 2

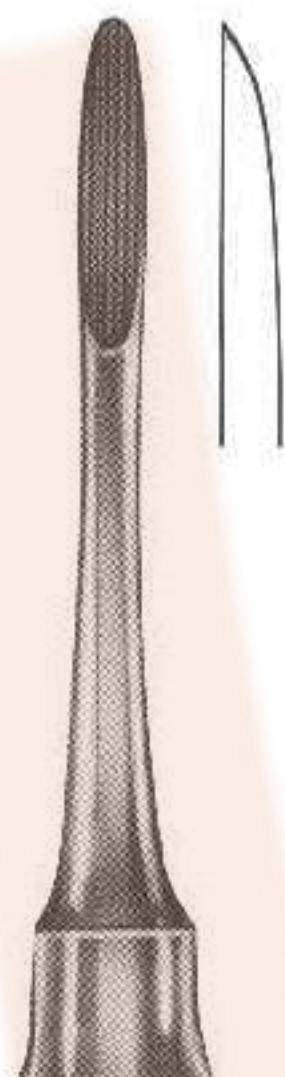

1233
Fig 3

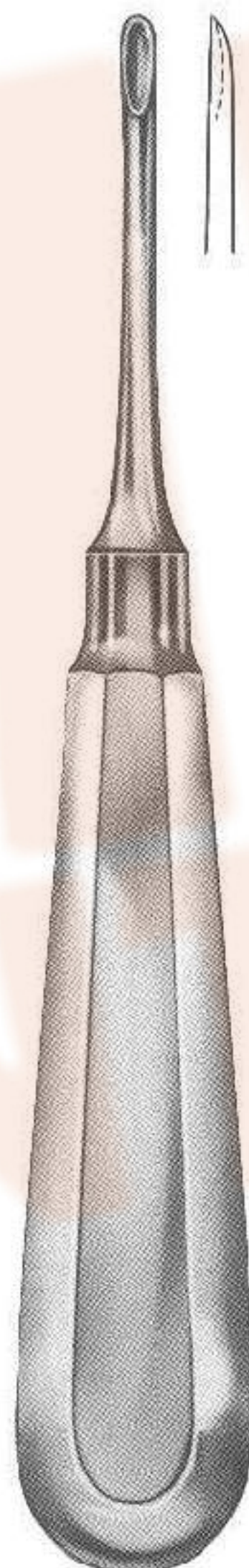

Flohr
1234
Fig 1



Flohr
1235
Fig 2



Flohr
1236
Fig 3



Root Elevators



**Kopp
1237
Fig 1**



**Kopp
1238
Fig 2**



**Kopp
1243
Fig 1**



**Kopp
1244
Fig 2**



**Kopp
1239
Fig 3**



**Kopp
1240
Fig 4**

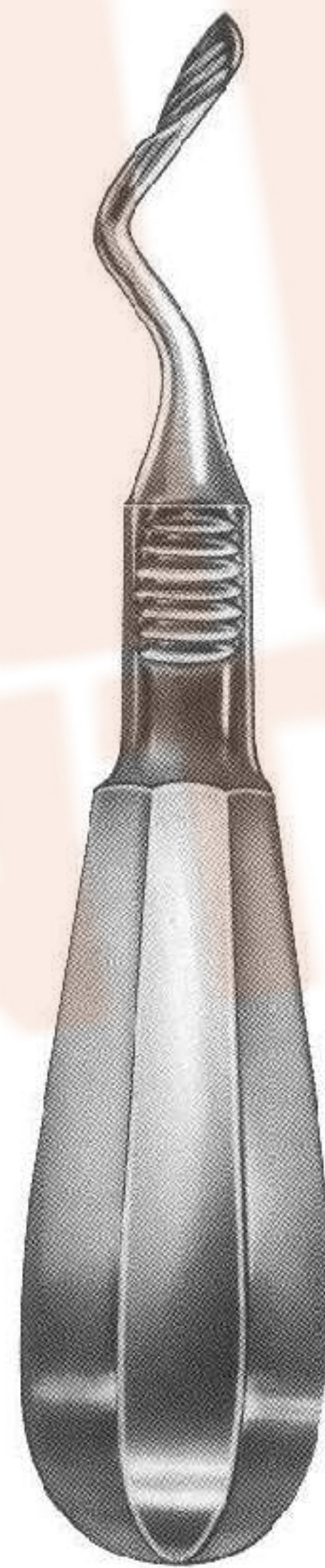

Kopp



**Kopp
1245
Fig 3**



**Kopp
1246
Fig 4**



**Kopp
1241
Fig 5**



**Kopp
1242
Fig 6**

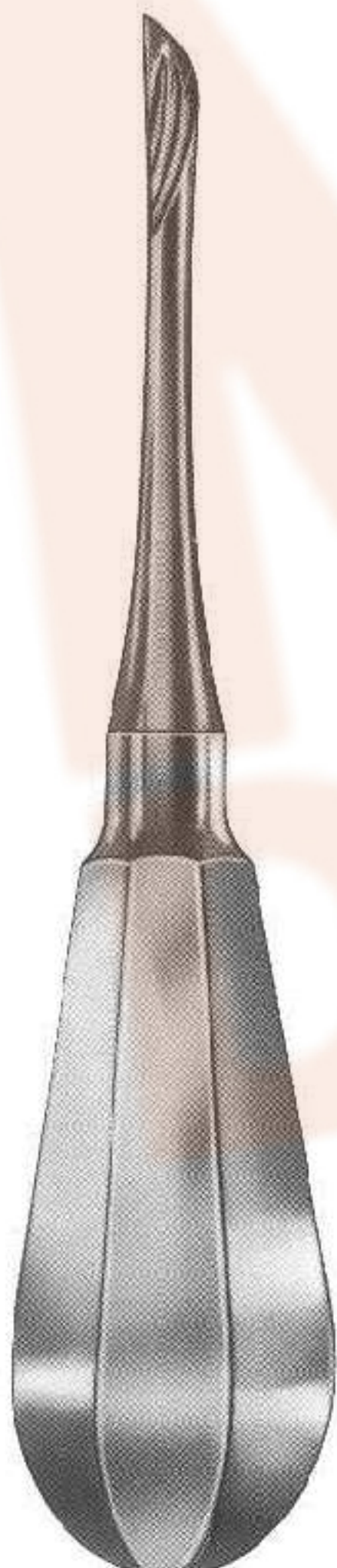

Kopp



Root Elevators

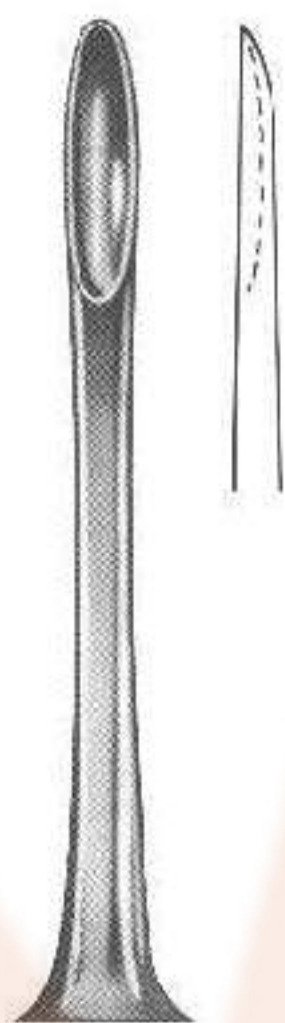

Hylin
1247
Fig 1

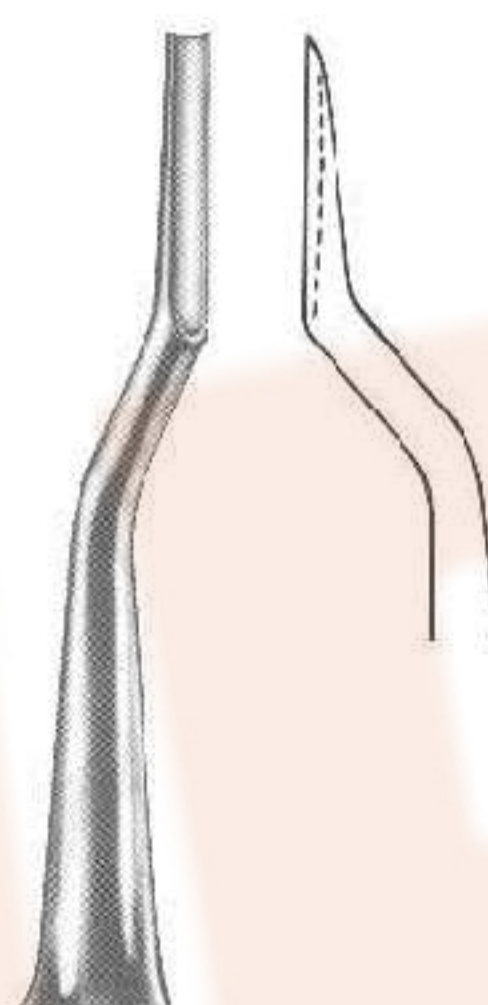

Bein
1249
Fig 1

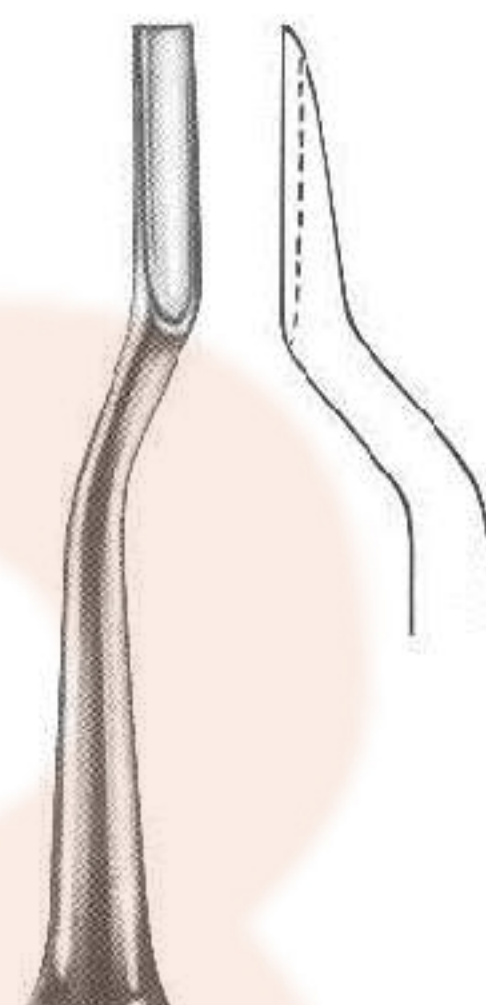

Bein
1250
Fig 2

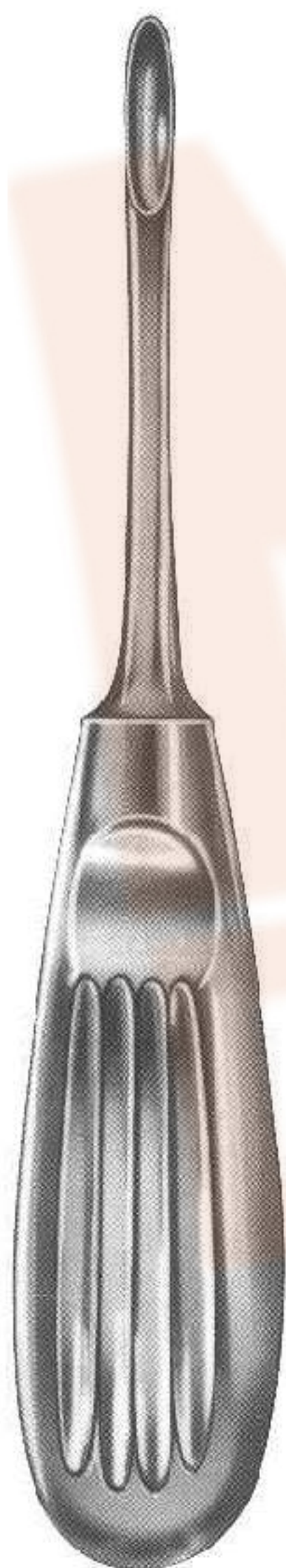

Hylin



Hylin
1248
Fig 2

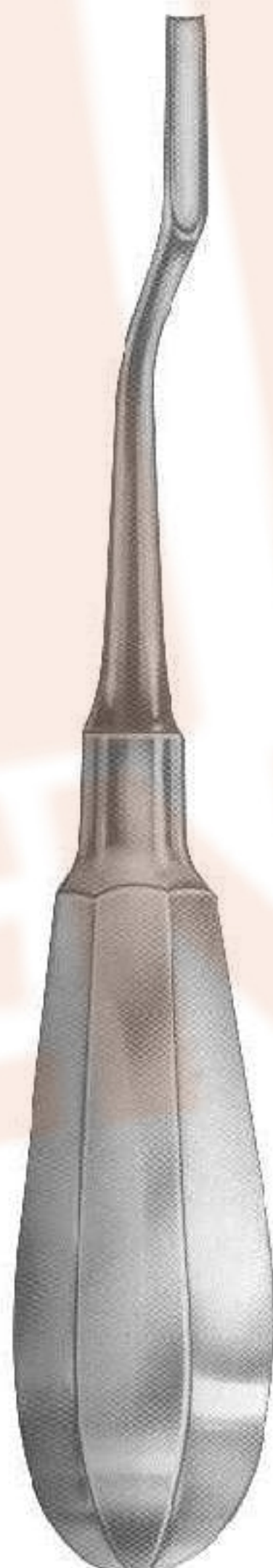

Bein

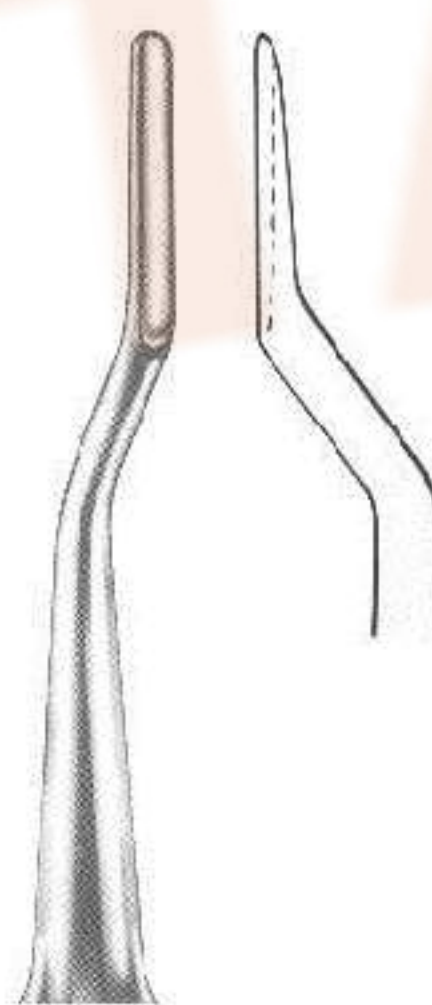

Bein
1251
Fig 3

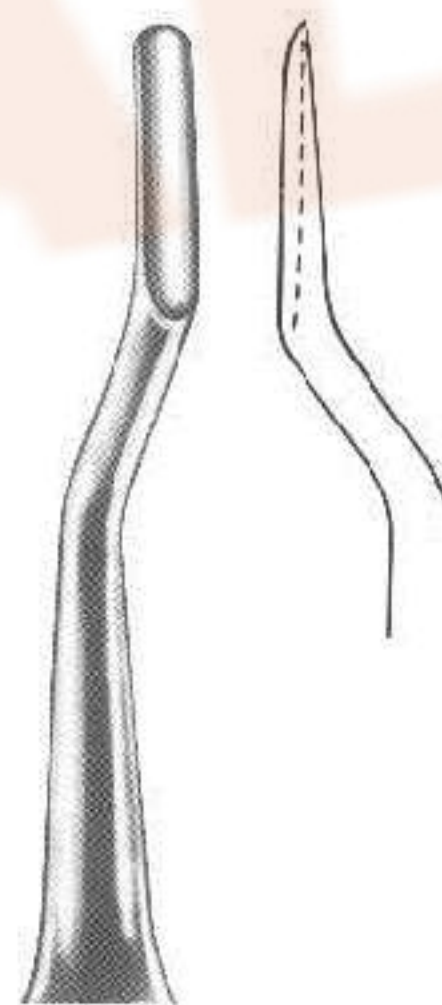

Bein
1252
Fig 4



Root Elevators



**Warwick-James
1253
Fig 1**



**Warwick-James
1254
Fig 2**



**Warwick-James
1255
Fig 3**



**London Hospital
1256
Fig 1**



**London Hospital
1257
Fig 2**

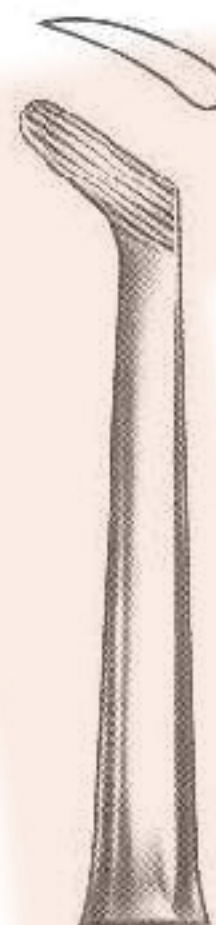

**London Hospital
1258
Fig 3**

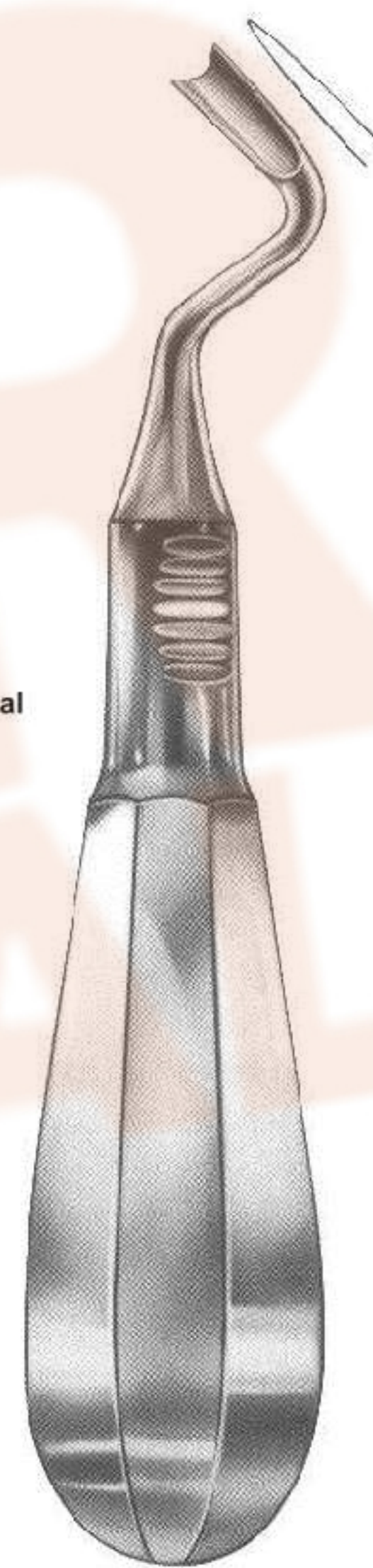

**Ott
1259**



Root Elevators

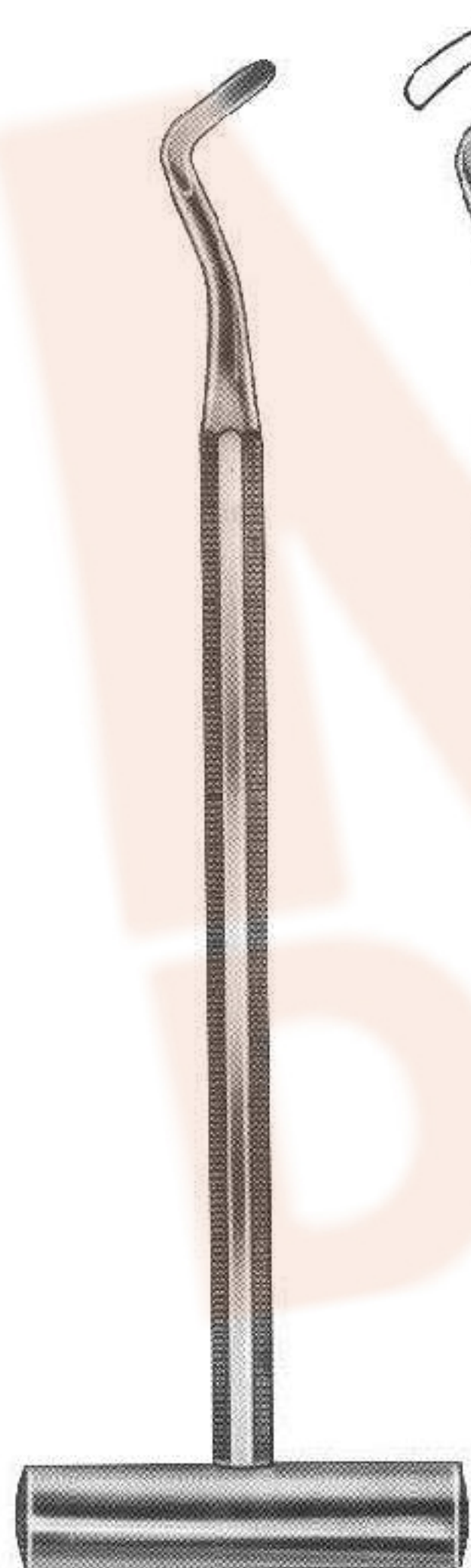

Pott



Pott
1260
Fig 1



Pott
1261
Fig 2

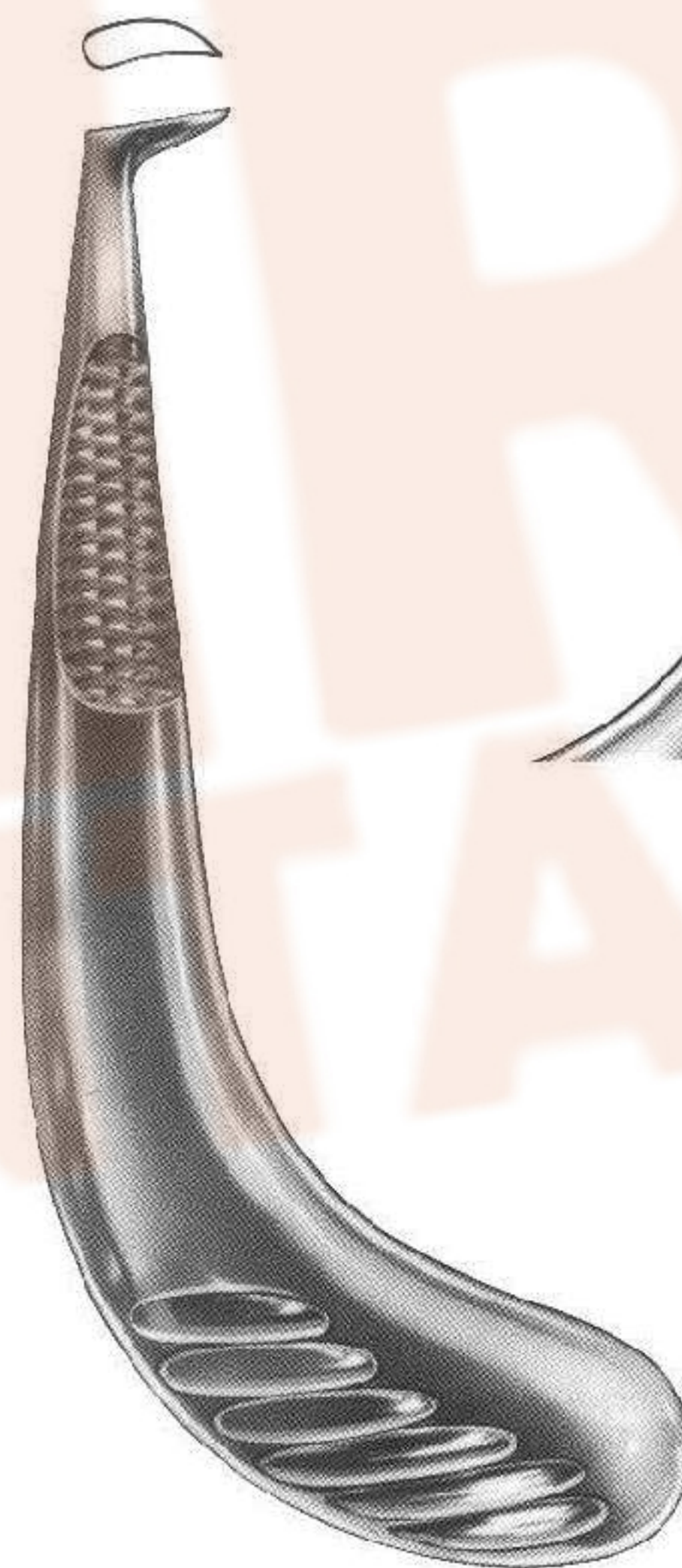

1262
Fig 1

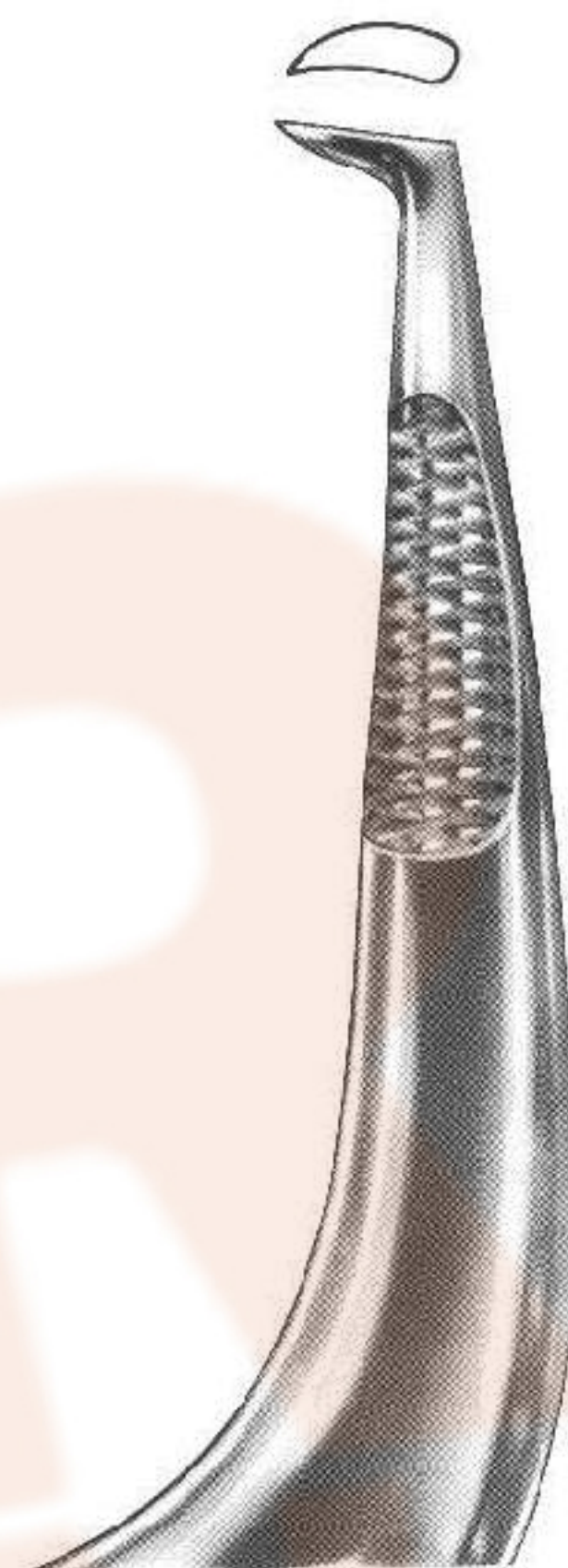

1263
Fig 2



Root Elevators



Mead
1265
MD-5 A



Mead
1266
MD-6 A



Mead
1267
MD-7 A



Mead
1268
MD-8



Mead
1264
MD 1



Lecluse
1269



Root Elevators



Chompret
1270
Fig 1



Chompret
1271
Fig 2



Chompret
1272
Fig 3

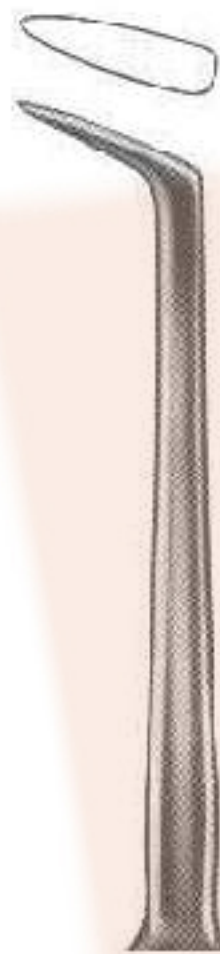

Chompret
1273
Fig 4

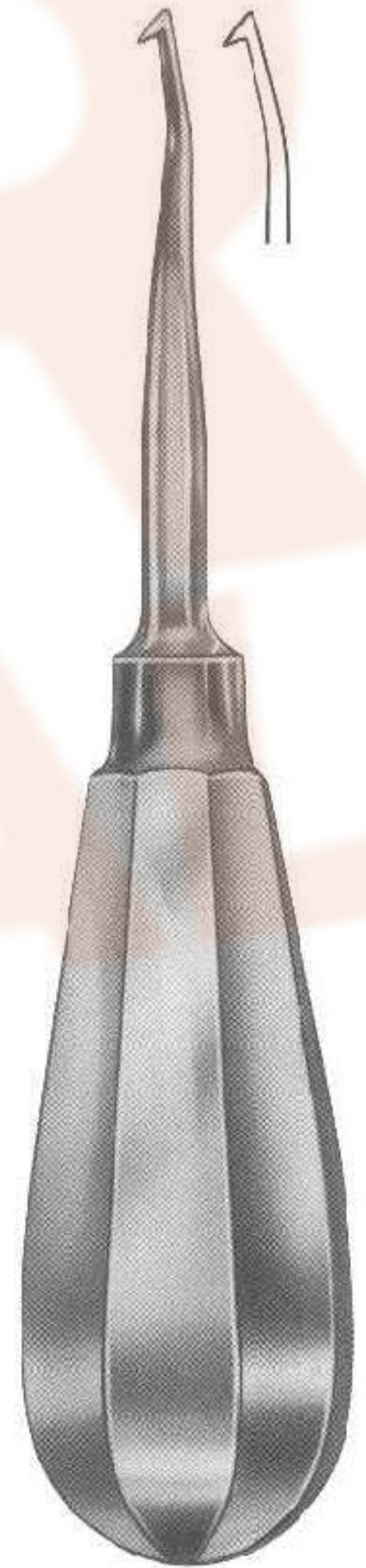

Apical
1274



Root Elevators, Root Tip Elevators



1275
Fig 1



1276
Fig 2



1277
Fig 3



Heidbrink
1278
Fig 1



Heidbrink
1279
Fig 2



Heidbrink
1280
Fig 3



Root Elevators

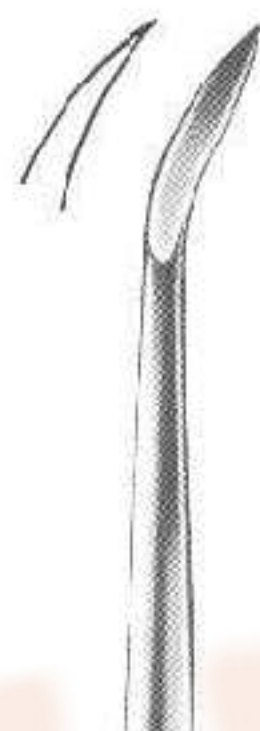

Winter
1281
Fig 1L

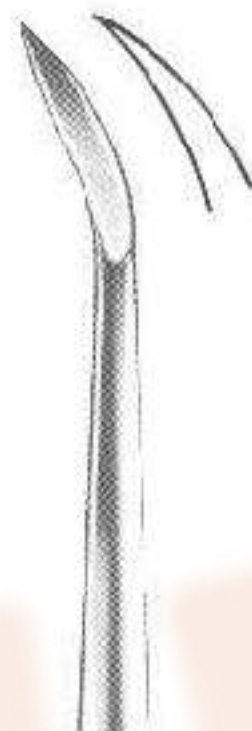

Winter
1282
Fig 1R



Winter
1283
Fig 2L



Winter
1284
Fig 2R



Winter
1285
Fig 11 L



Winter
1286
Fig 11 R



Winter
1287
Fig 12 L



Winter
1288
Fig 12 R

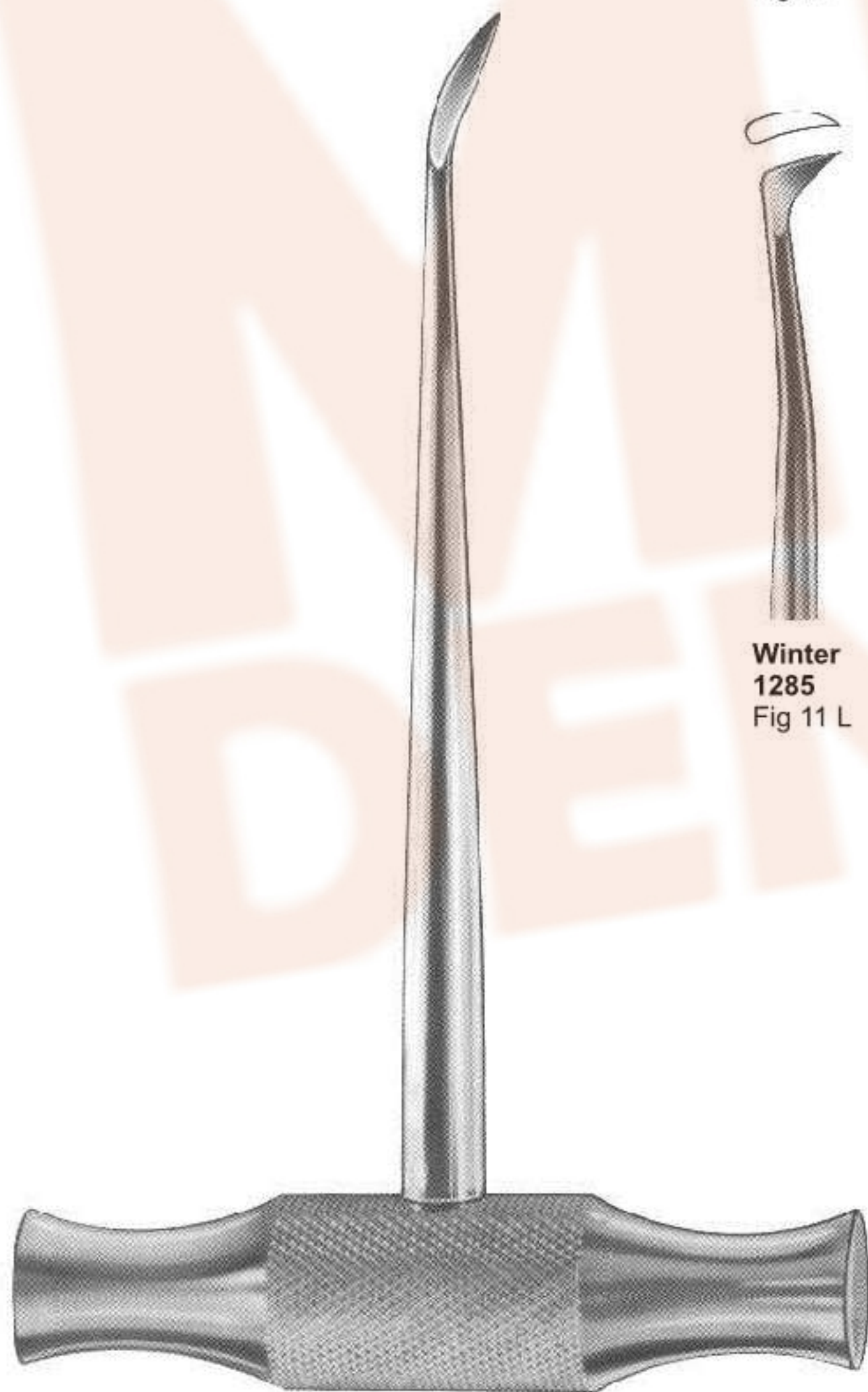

Winter



Winter
1289
Fig 14 L



Winter
1290
Fig 14 R



Root Elevators



Barry
1291
Fig 1



Barry
1292
Fig 2



Barry
1293
Fig 3



Barry
1294
Fig 4

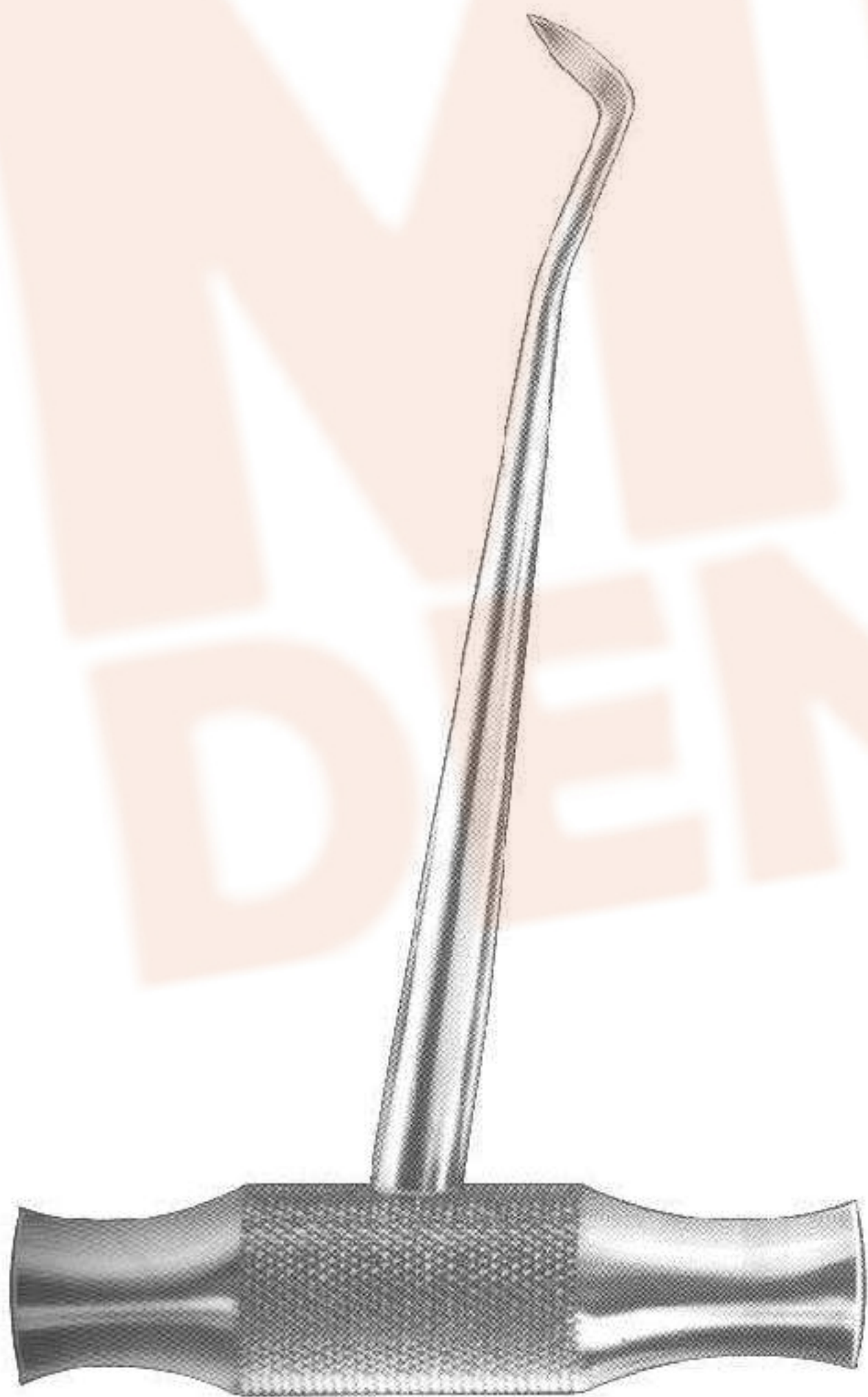

Barry

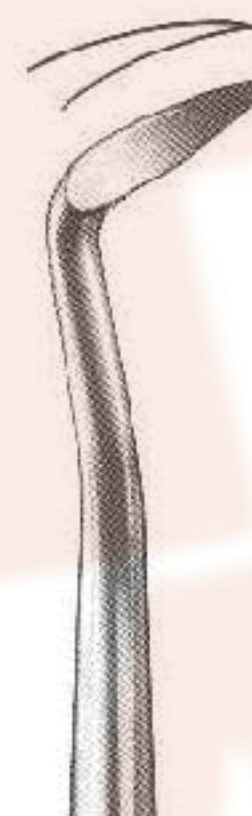

Barry
1295
Fig 11



Barry
1296
Fig 12



Barry
1297
Fig 17



Barry
1298
Fig 18



Root Elevators



Cryer
1300
Fig 26



Seldin
1301
Fig 27



Cryer
1302
Fig 28



Cryer
1303
Fig 29



Heidbrink
1304
Fig 22



Heidbrink
1305
Fig 23

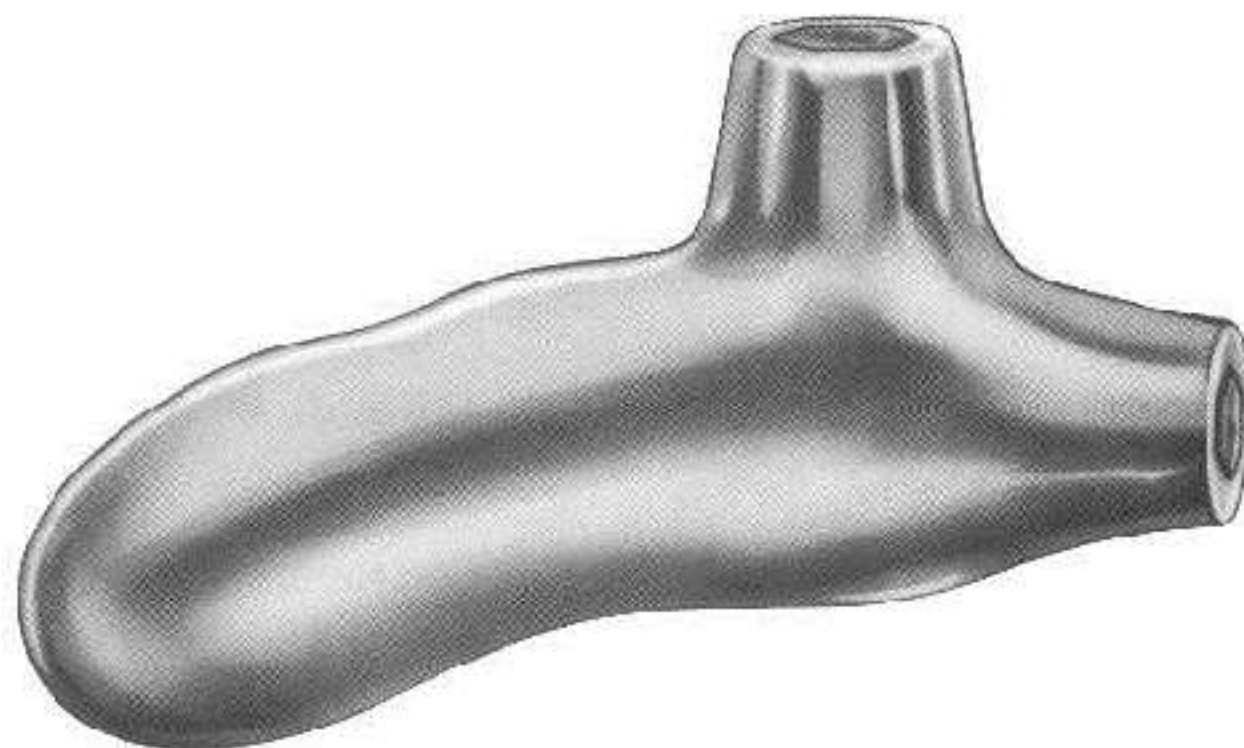

1299

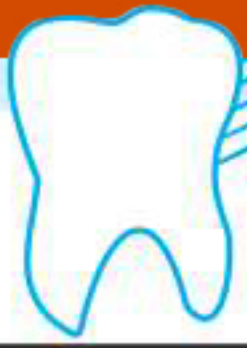

Root Elevators



**Kopp
1307**
Fig 31



**Kopp
1308**
Fig 32



**Kopp
1309**
Fig 33



**Kopp
1310**
Fig 34



**Kopp
1311**
Fig 35



**Kopp
1312**
Fig 44

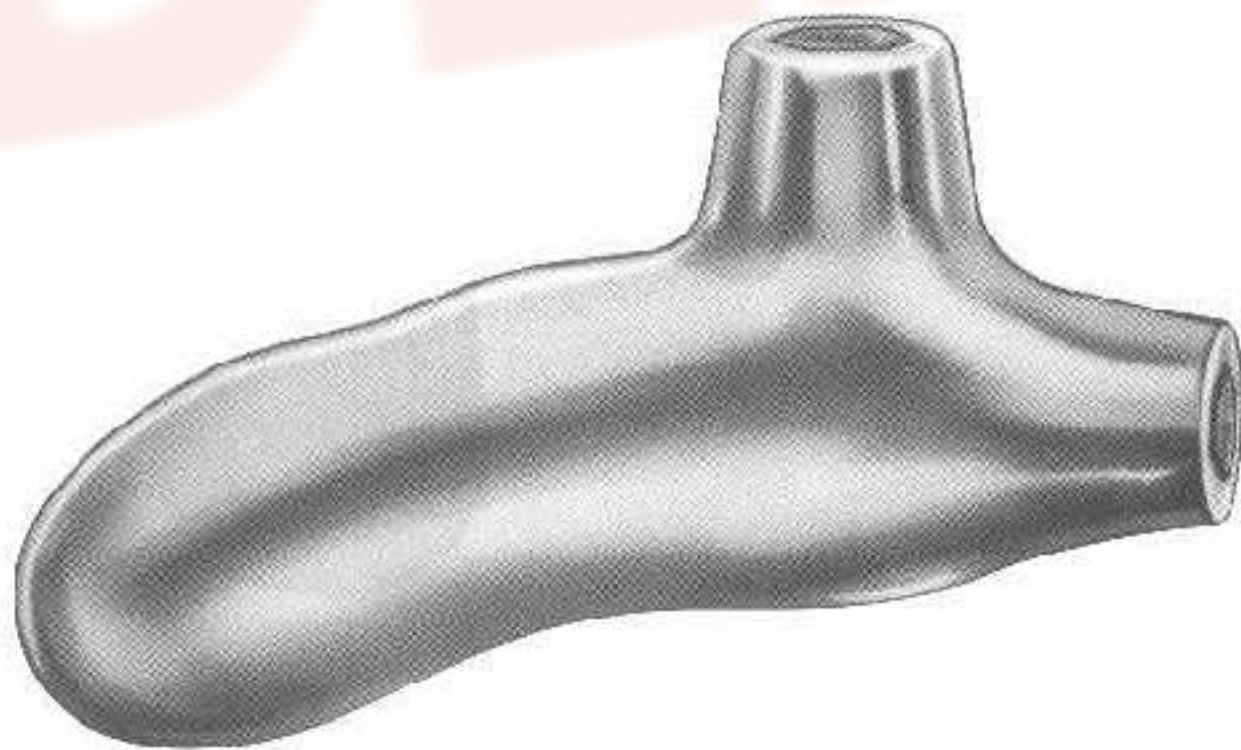

1306

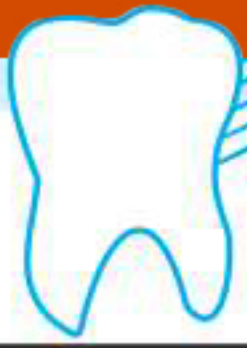

Root Elevators



**Heidbrink
1314
Fig 10**



**Winter
1315
Fig 11**



**Winter
1316
Fig 12**



**Barry
1317
Fig 17**



**Barry
1318
Fig 18**



**1319
Fig 20**

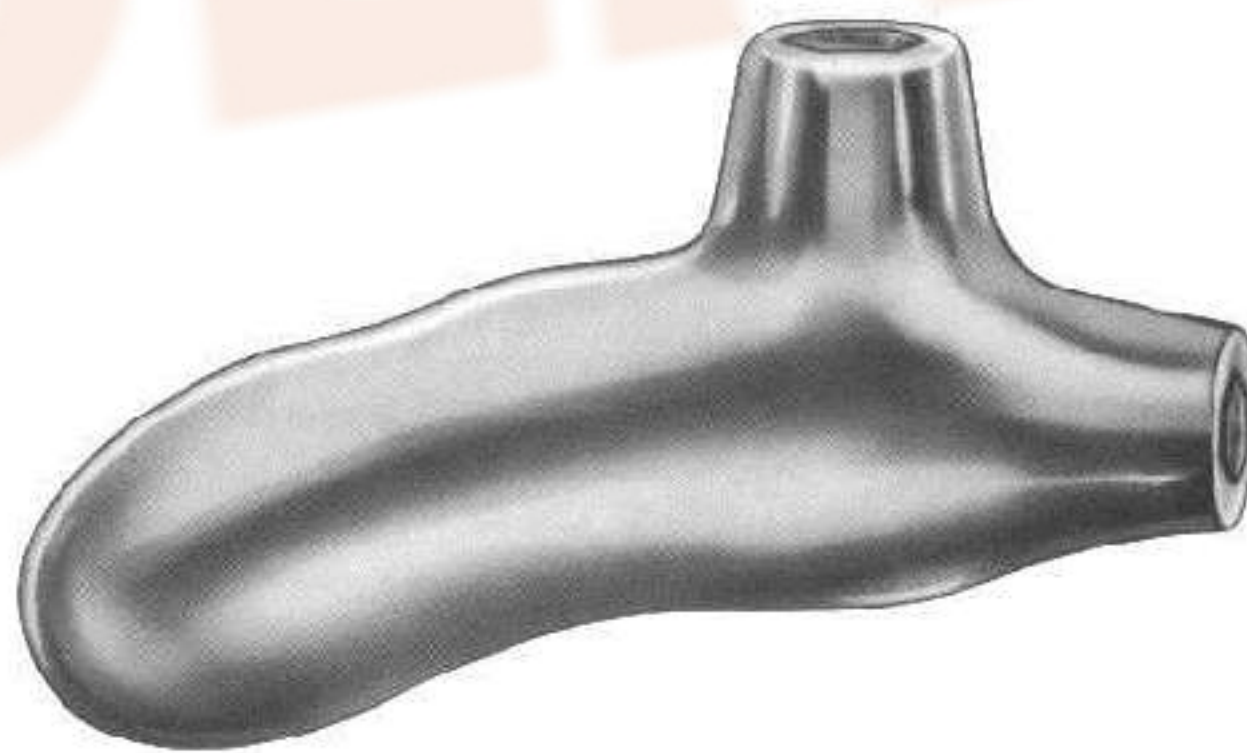

1313



Root Elevators

Root Elevators according to Dr. Sader,
with interchangeable working tips



1321

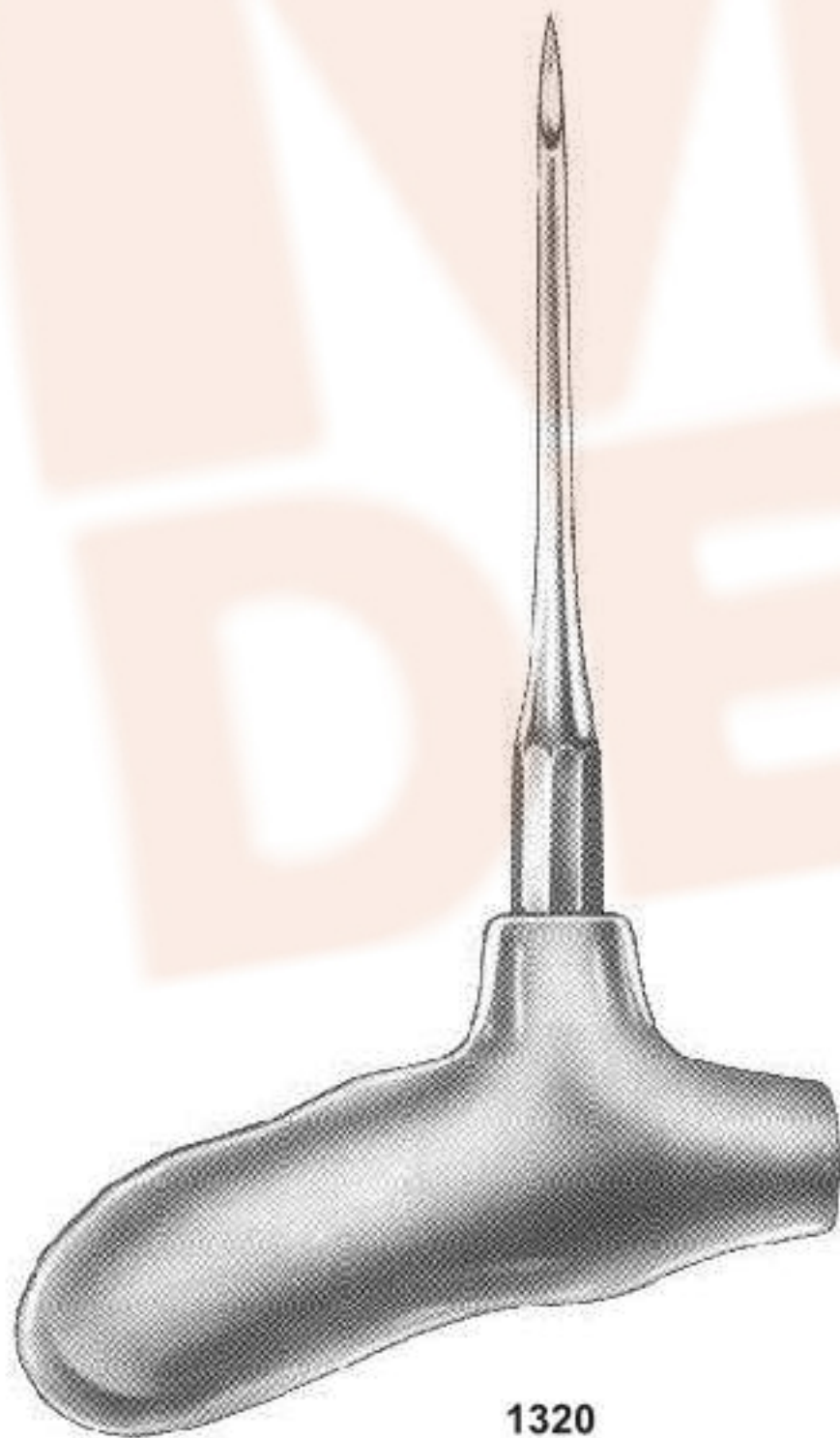

1320

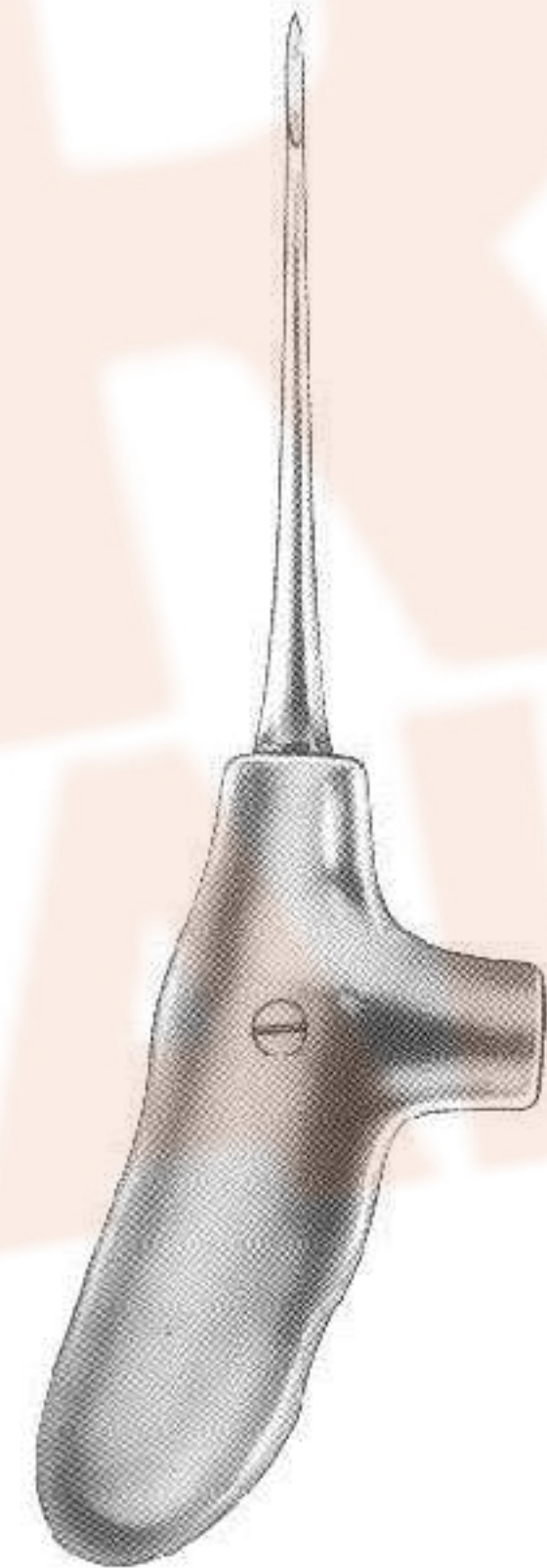

1322

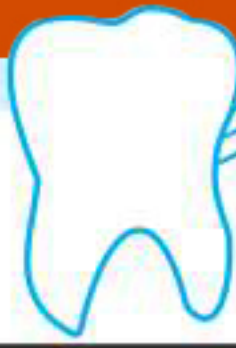

Filling Instruments

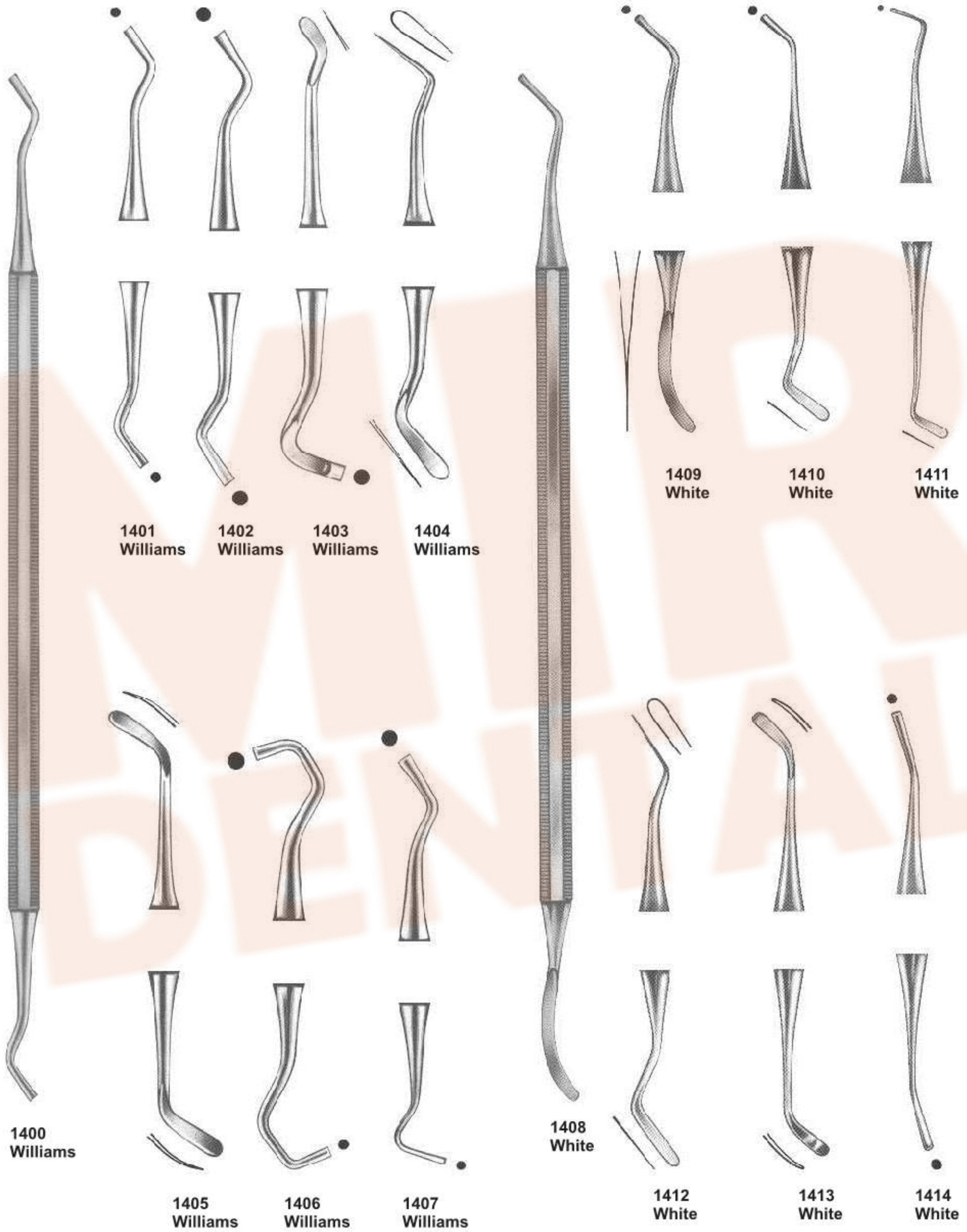

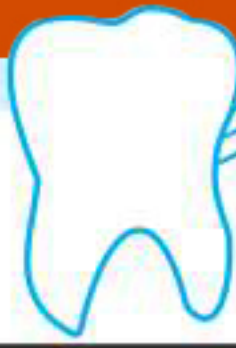

Filling Instruments

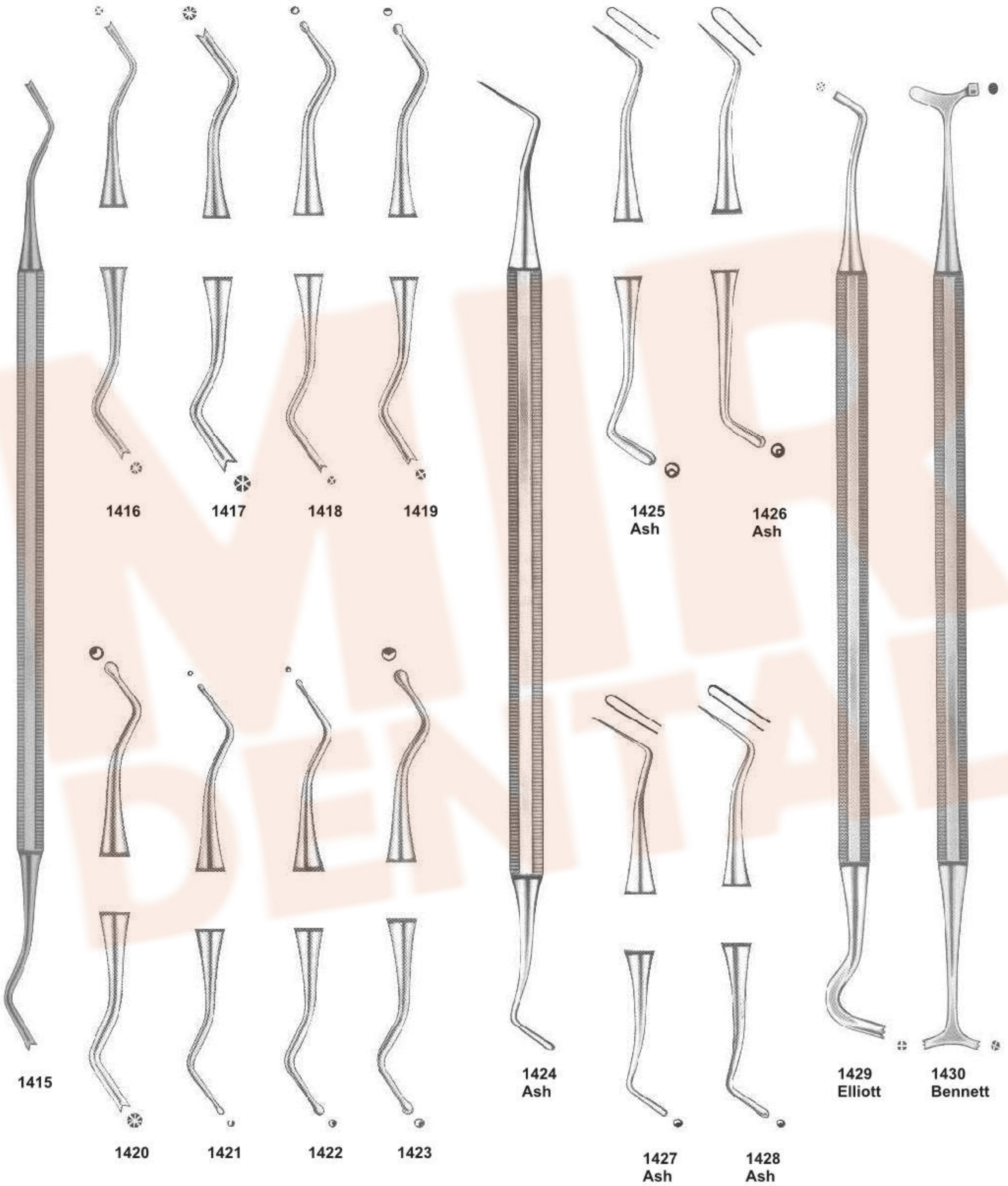

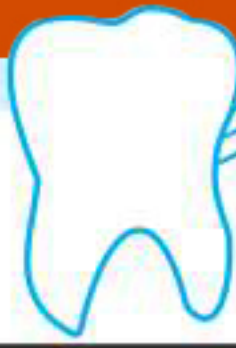

Filling Instruments

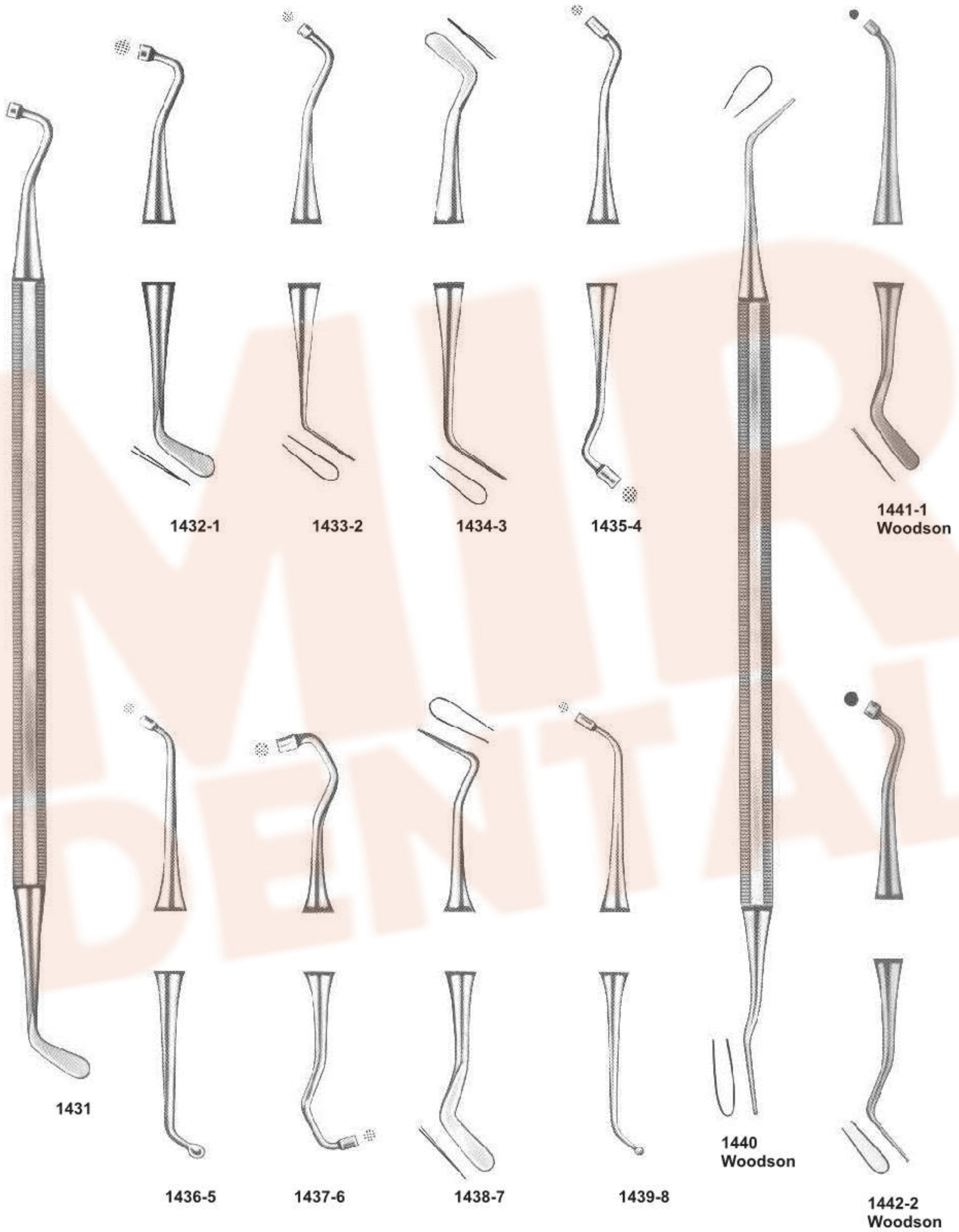



Filling Instruments



1443
Heidemann
Fig 1

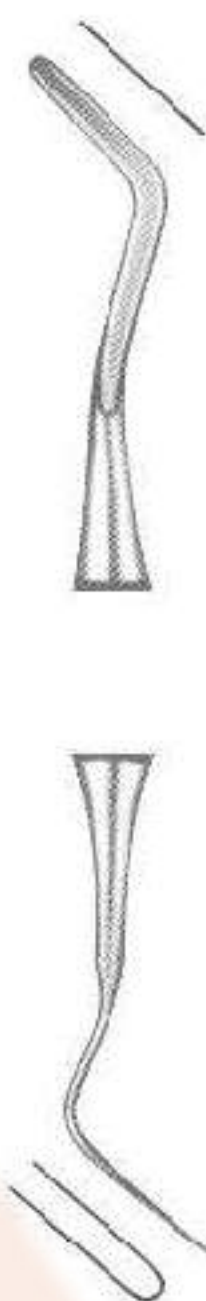

1444
Heidemann
Fig 2



1445
Heidemann
Fig 3



1446



1447
Fig 146



1448
Fig 147



1449
Fig 148



1450
Fig 149



1451
Fig 158



1452
Fig 159

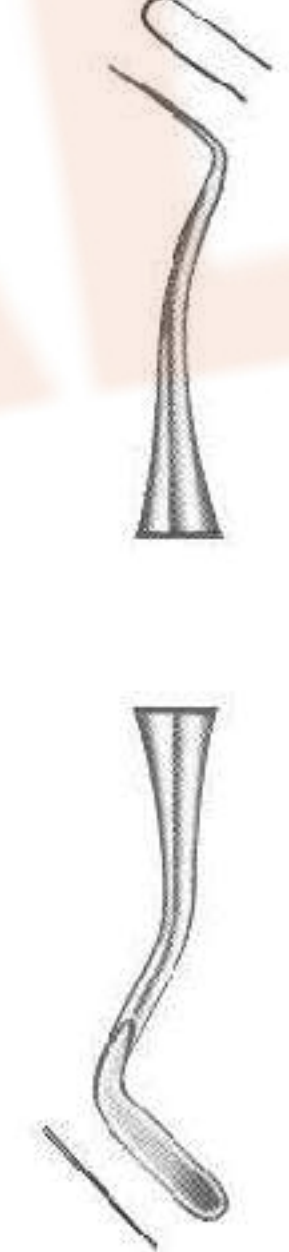

1453
Woodson
Fig 160

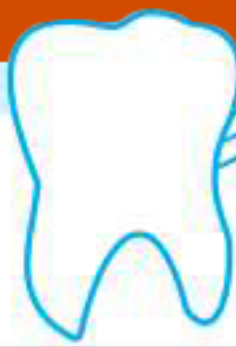

Periodontal Currettes and Filling Instruments



1454
Gracey



1455
Gracey
Fig 1

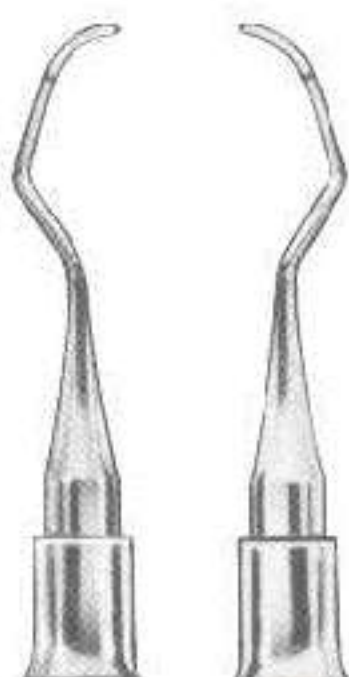

1456
Gracey
Fig 2

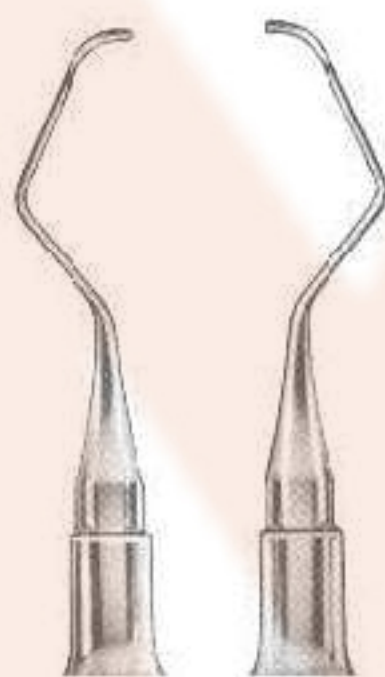

1457
Gracey
Fig 3

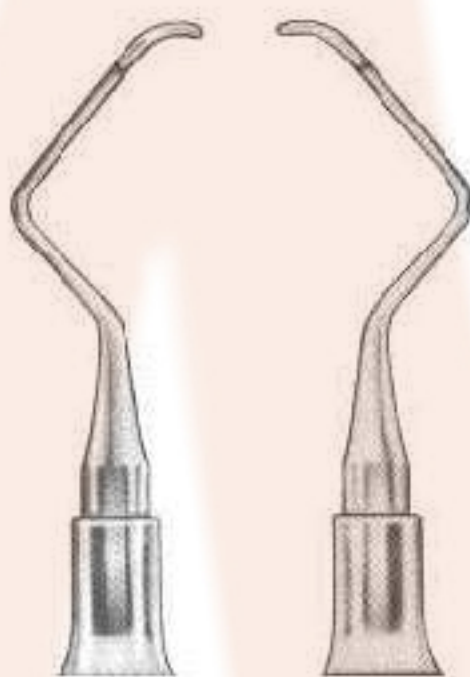

1458
Gracey
Fig 4



1459
Gracey
Fig 5

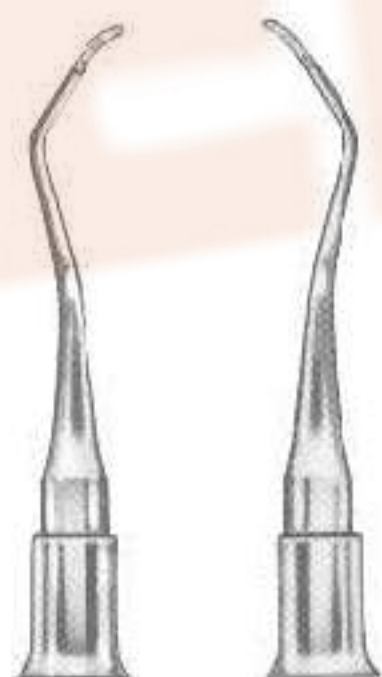

1460
Gracey
Fig 6

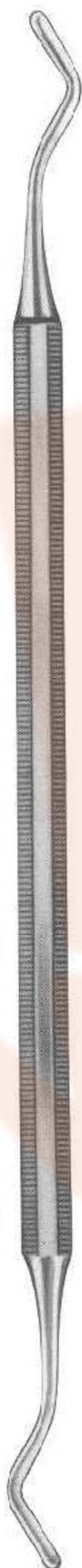

1461



1462-1
Fig 18



1463-2
Fig 19



1464-3
Fig 20



1465-4
Fig 22



1466-5
Fig 23



1467-6
Fig 25



1468-7
Fig 26



1469-8
Fig 27



Dental Probes

With Point Set In



1470



1471-1



1472-2



1473-3



1474-4



1475-5



1476-6



1477-7



1478-8



1479-9



1480-10

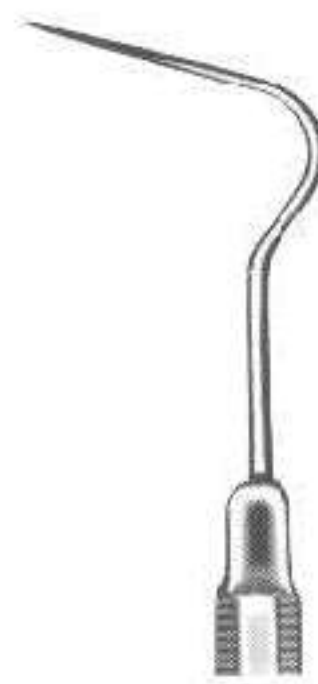

1481-11



1482-2
Woodson



Burnishers and Pocket Probes Scalers

Polishing Instruments

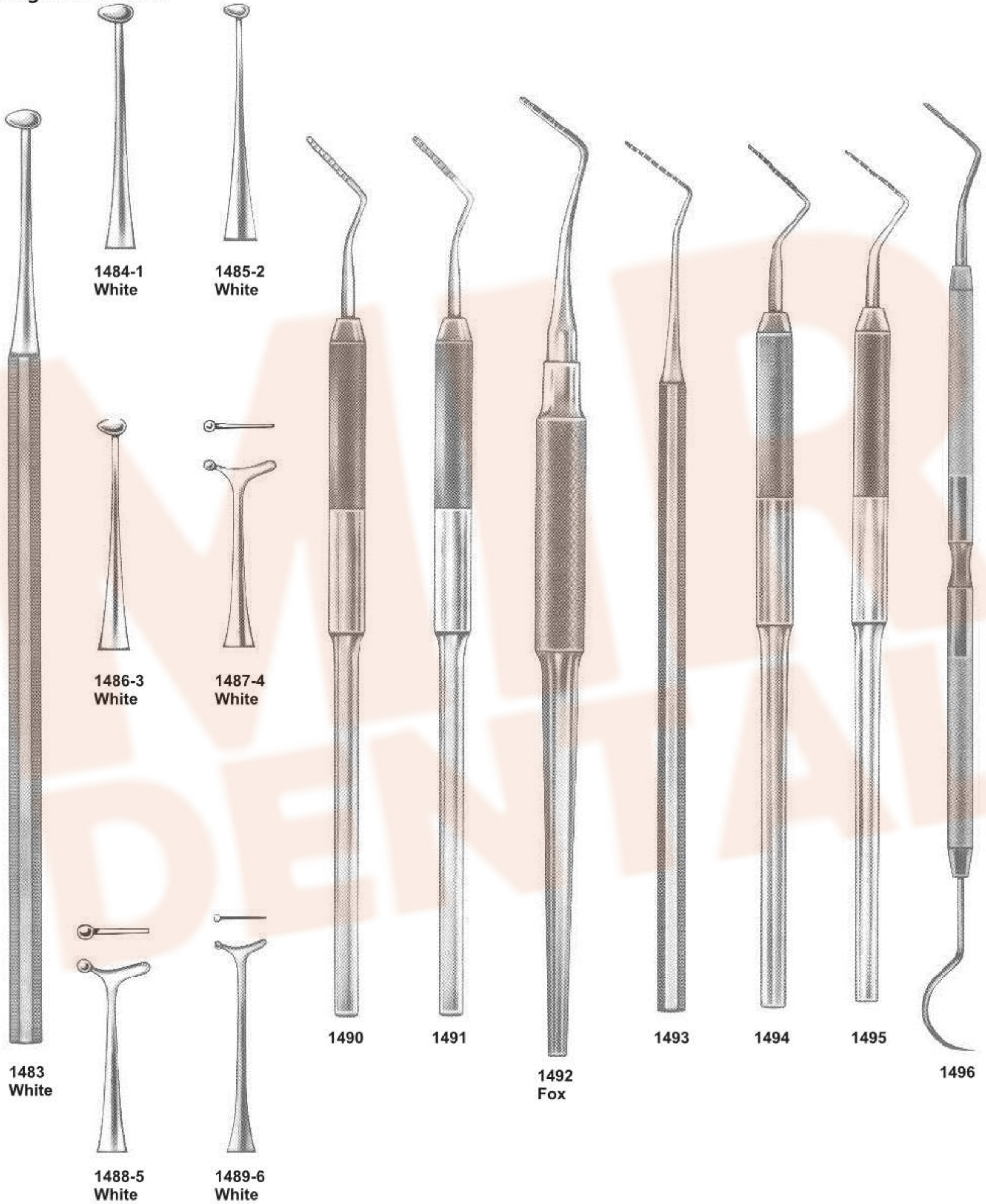



Periodontal Pocket Probes

MIR
DENTAL

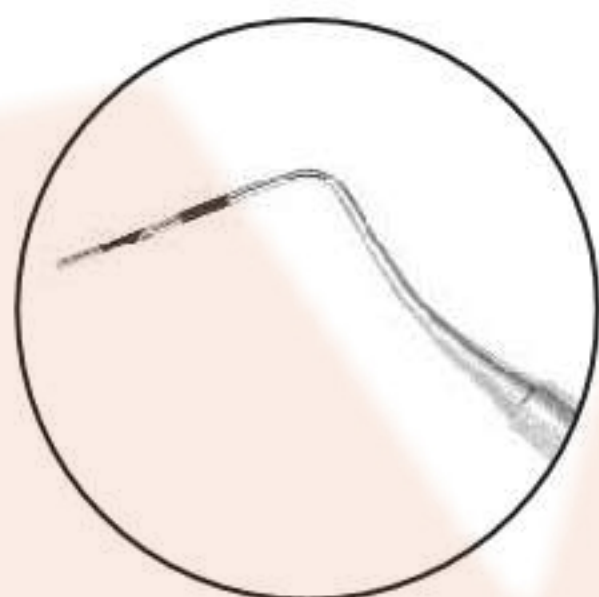

- New marking process.
- Laser system marking.
- No more paint peeling off.
- Permanent marking.
- Antiglare, low depth marking.
- Maximum tip resistance against breaking.



1497
Fig CP-C



1498
Fig CP-11



1499
Fig CP-12



1500
Fig CP-12S
O.M.S



Periodontal Pocket Probes

MIR
DENTAL



1501
Williams



1502
Merrit A



1503
Merrit B



1504
Goldman
Fox



1505
University of
Michigan



1506
26 G



Files

Chisels

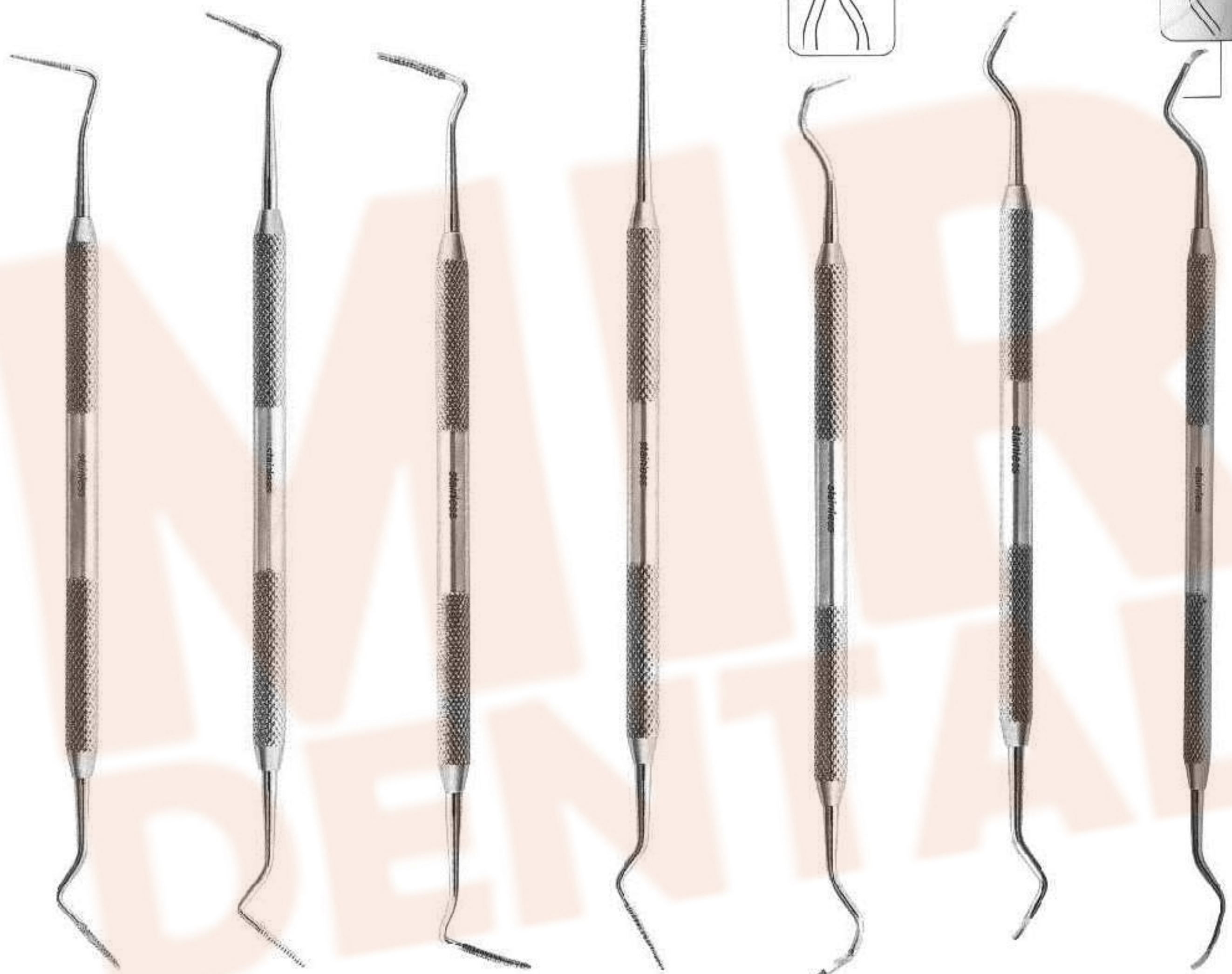

1507 Sugarman Fig. 1S/2S

1508 Sugarman Fig. 3S/4S

1509 Schluger Fig. 9/10

1510 Buck Fig. 11/12

1511 Ochsenbein Fig. 3

1512 Ochsenbein Fig. 4

1513 Rhodes Back - Action Fig. 36/37



Gingivectomy knives



1521
Goldman-Fox
Fig. 7

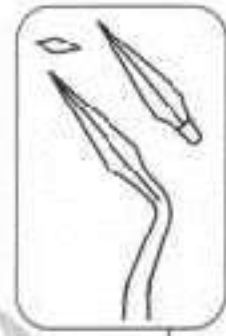

1522
Goldman-Fox
Fig. 8



1523
Goldman-Fox
Fig. 9



1524
Goldman-Fox
Fig. 11



1525
Buck
Fig. 3/4



1526
Buck
Fig. 5/6



Curettes and Scalers



1527
Curette
Fig. HU 1/2

1528
Columbia
Fig. 2R/2L

1529
Columbia
Fig. 4R/4L

1530
Columbia
Fig. 13/14

1531
Fig. 411/412

1532
Fig. 413/414

1533
Zerfing-chisel



Gingivectomy knives



1534
Goldman - Fox
Fig. 7

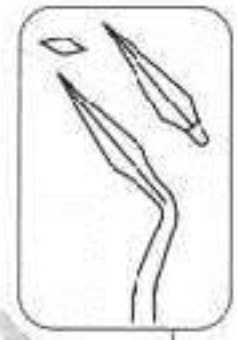

1535
Goldman - Fox
Fig. 8



1536
Goldman - Fox
Fig. 9



1537
Goldman - Fox
Fig. 11



1538
Buck
Fig. 3/4

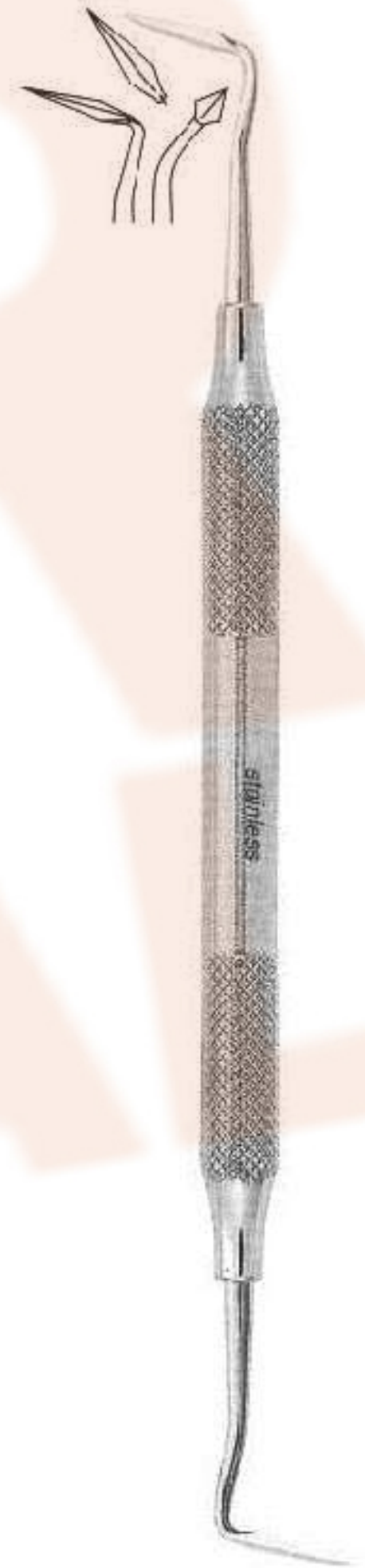

1539
Buck
Fig. 5/6



Curettes and Scalers

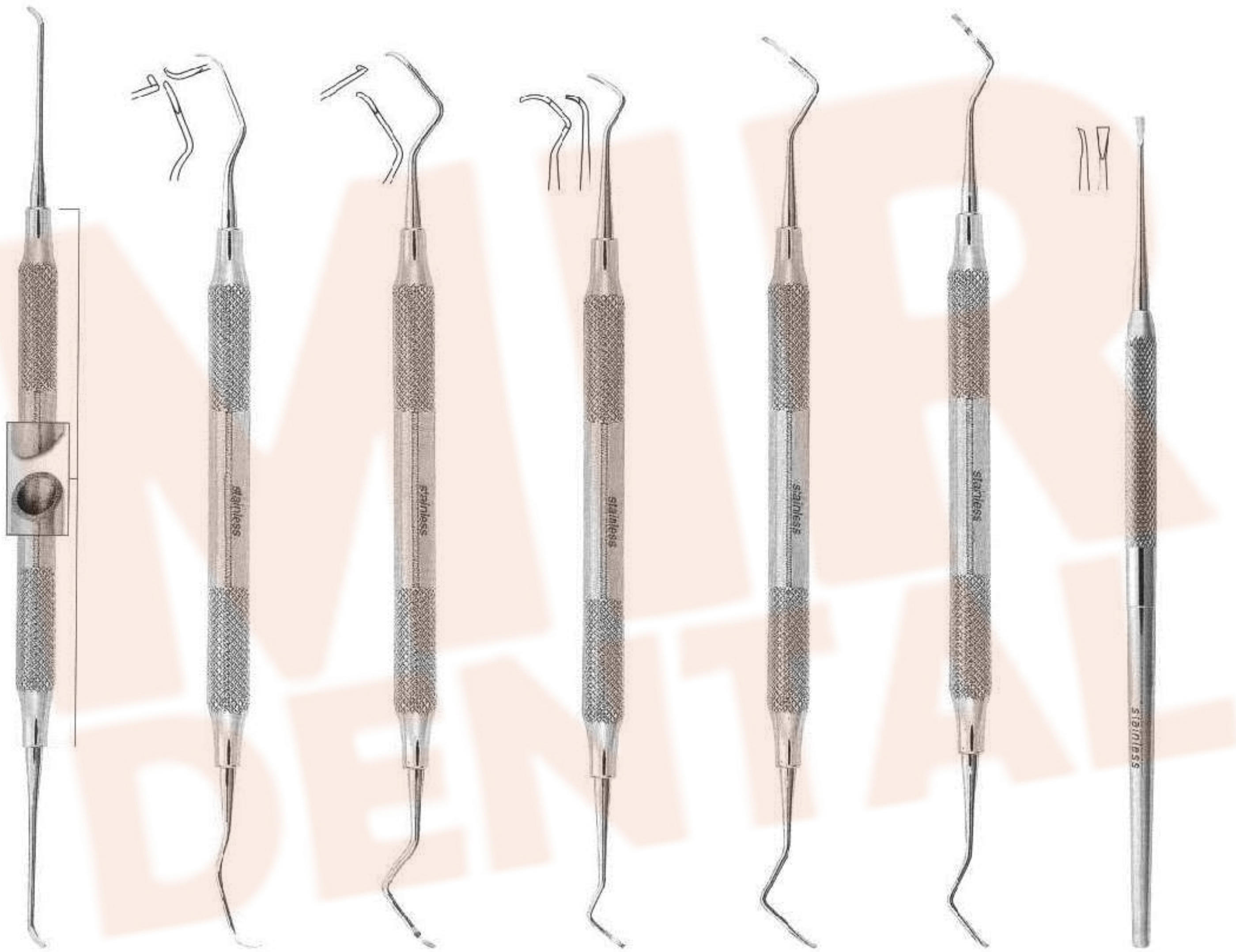

1540
Curette
Fig. HU 1/2

1541
Columbia
Fig. 2R/2L

1542
Columbia
Fig. 4R/4L

1543
Columbia
Fig. 13/14

1544
Fig. 413/412

1545
Fig. 411/414

1546
Zerfing-chisel



Bone Chisels and Gouges



1547
Ochsenbein
Fig. 1

1548
Ochsenbein
Fig. 2

1549
Gardner
Fig. 1

1550
Gardner
Fig. 2

1551
Gardner
Fig. 5

1552
Gardner
Fig. 5R

1553
Gardner
Fig. 6

1554
Wakefield
Fig. 1W

1555
Wakefield
Fig. 2W

1556
Buckley
Fig. 3



Bone Chisels and Gouges

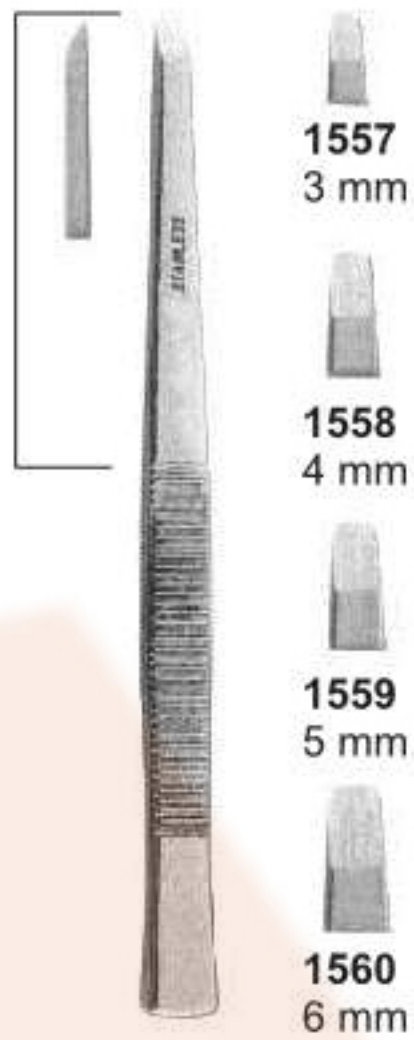

1557
3 mm

1558
4 mm

1559
5 mm

1560
6 mm

Partsch
13,5 cm



1561
3 mm

1562
4 mm

1563
5 mm

1564
6 mm

Partsch
13,5 cm

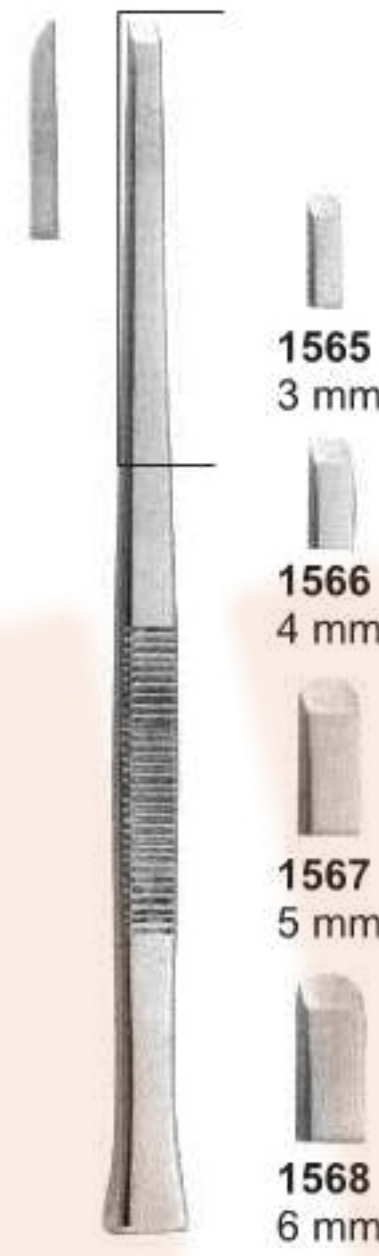

1565
3 mm

1566
4 mm

1567
5 mm

1568
6 mm

Partsch
17 cm



1569
3 mm

1570
4 mm

1571
5 mm

1572
6 mm

Partsch
17 cm

Martelli chirurgici
Mallet

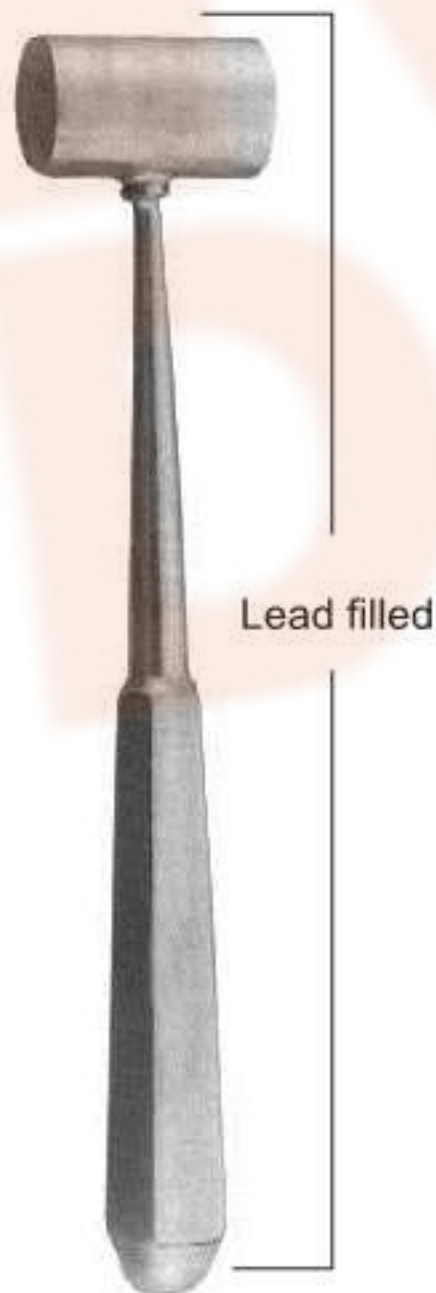

Lead filled

1573
Partsch
19 cm



Non autoclavable
plastic inserts

1574
Mead
19,5 cm

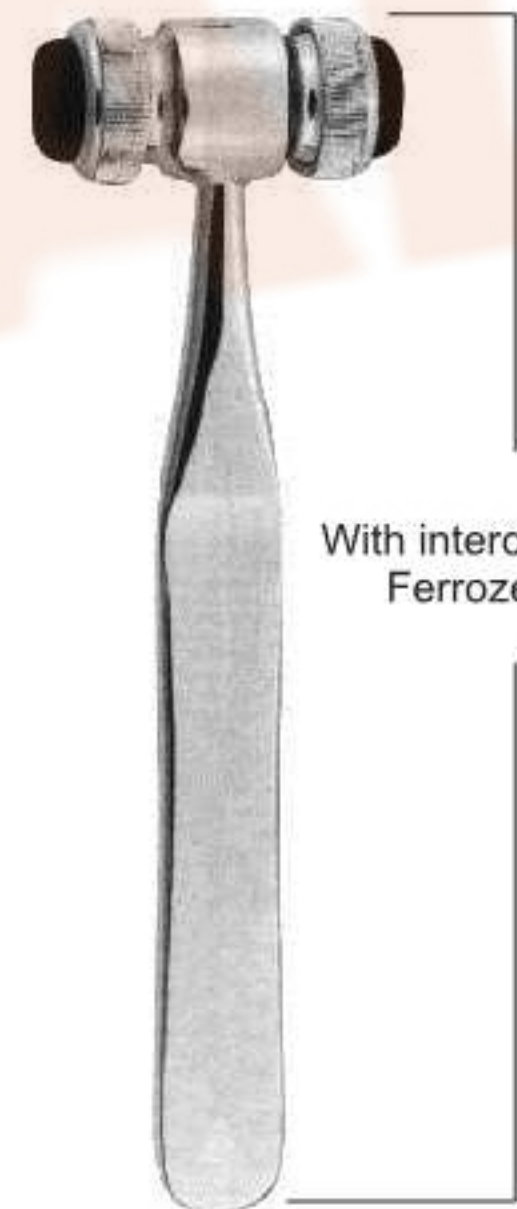

With interchangeable
Ferozel faces

1575
Mead
17 cm



Gracey Currettes

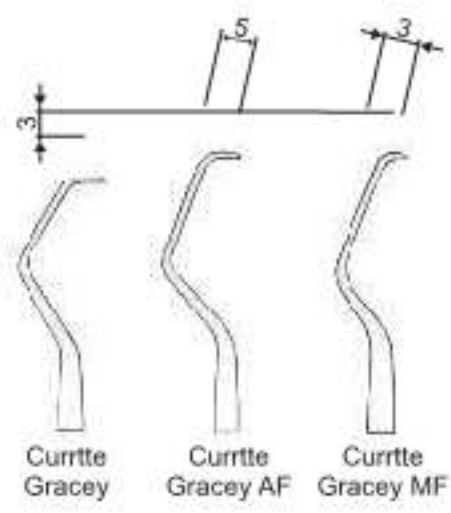

1576
Gracey
Fig. 1/2



1577
Gracey
Fig. 3/4



1578
Gracey
Fig. 5/6



1579
Gracey
Fig. 7/8



1580
Gracey
Fig. 9/10



1581
Gracey
Fig. 11/12



1582
Gracey
Fig. 13/14



1583
Gracey
Mesial Distal
Fig. 11/14



1584
Gracey
Mesial Distal
Fig. 12/13



Gracey Curettes AF Type

MIR
DENTAL

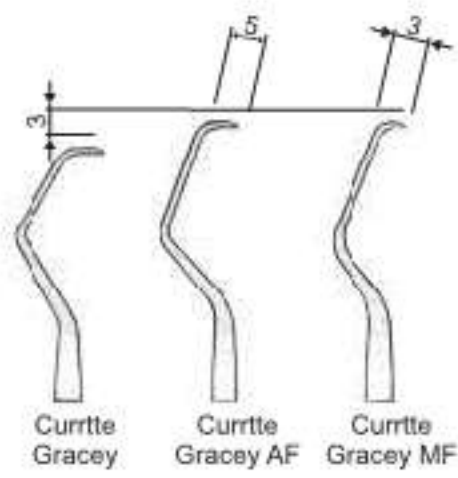

1585
Gracey
AF/type
Fig. 1/2



1586
Gracey
AF/type
Fig. 3/4



1587
Gracey
AF/type
Fig. 5/6



1588
Gracey
AF/type
Fig. 7/8



1589
Gracey
AF/type
Fig. 11/12



1590
Gracey
AF/type
Fig. 13/14



1591
Gracey
AF/type
Fig. 15/16



Gracey Curettes, AF, MF, Type



1592
Gracey
AF/type

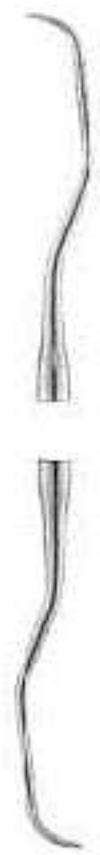

1593
Gracey
AF/type
Fig. 1/2



1594
Gracey
AF/type
Fig. 3/4



1595
Gracey
AF/type
Fig. 5/6



1596
Gracey
AF/type
Fig. 7/8



1597
Gracey
AF/type
Fig. 11/12



1598
Gracey
AF/type
Fig. 13/14



1599
Gracey
AF/type
Fig. 15/16



1600
Gracey
MF/type
Fig. 1/2



1601
Gracey
MF/type
Fig. 3/4



1602
Gracey
MF/type
Fig. 5/6



1603
Gracey
MF/type
Fig. 7/8

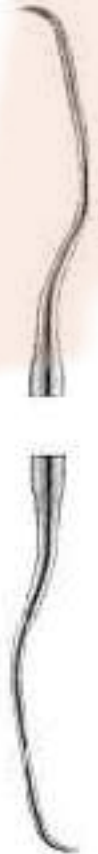

1604
Gracey
MF/type
Fig. 11/12



1605
Gracey
MF/type
Fig. 13/14



1606
Gracey
MF/type
Fig. 15/16



Curettes Gracey AF Type

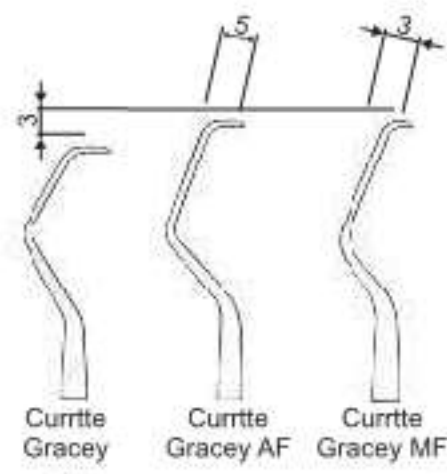

1607
Gracey
MF/type
Fig. 1/2



1608
Gracey
MF/type
Fig. 3/4



1609
Gracey
MF/type
Fig. 5/6



1610
Gracey
MF/type
Fig. 7/8



1611
Gracey
MF/type
Fig. 11/12



1612
Gracey
MF/type
Fig. 13/14



1613
Gracey
MF/type
Fig. 15/16



Curettes and Scalers



1614
Goldman - Fax
Fig. 1

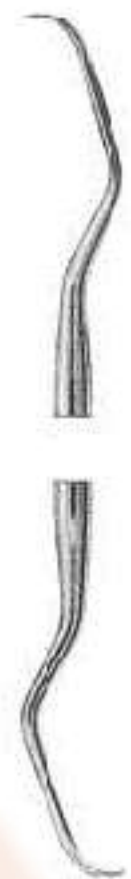

1615
Goldman - Fax
Fig. 2



1617
Goldman - Fax
Fig. 3



1618
Goldman - Fax
Fig. 4



1621
Mc Call
Fig. 13S/14S



1622
Younger-Good
Fig. 7/8

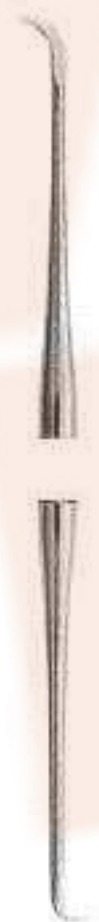

1619
Goldman - Fax
Fig. 21

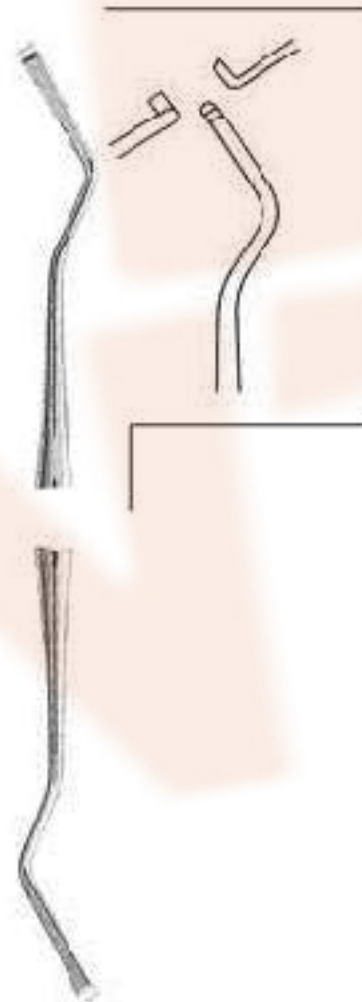

1620
Goldman - Fax
Fig. 5



Curettes and Scalers

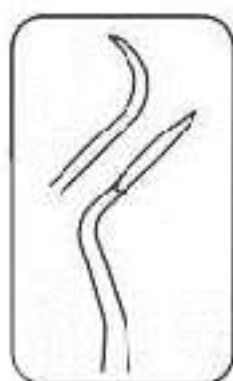

1623
Towner
Fig. U15



1624
Crane - Kaplan
Fig. 6

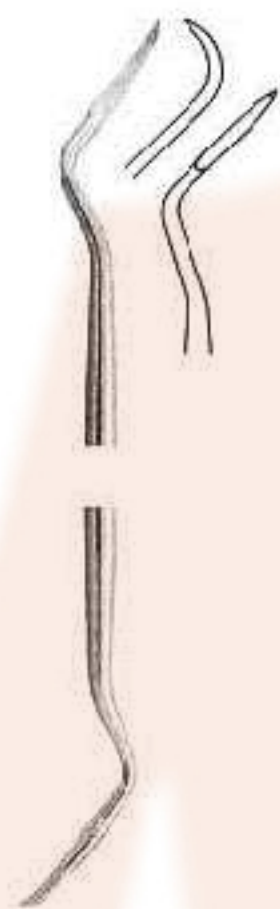

1625
Crane - Kaplan
Fig. 6S

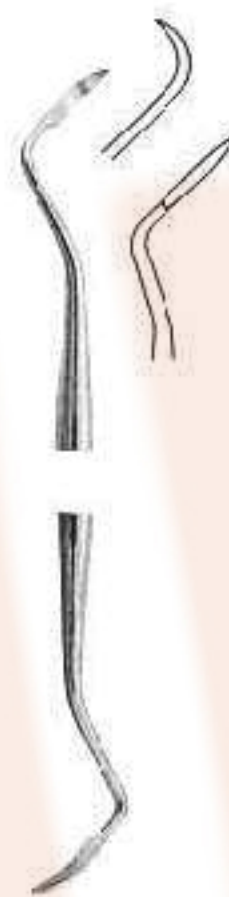

1626
Taylor
Fig. 2/3



1627
Fig. 204S



1628
Towner Jaquette
Fig. U15/33



1633
Jaquette
Fig. 2



1629
Columbia
Fig. 2R/2L

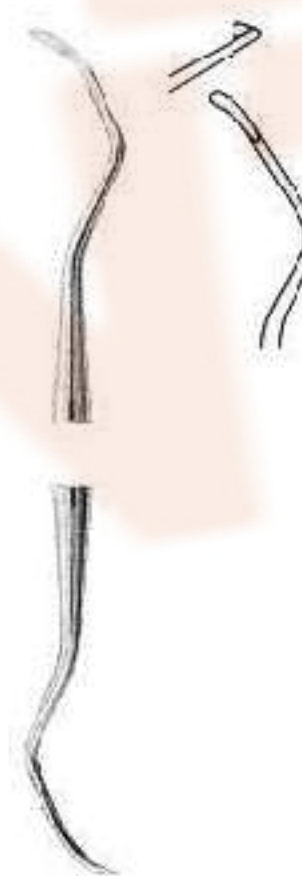

1630
Columbia
Fig. 4R/4L



1631
Columbia
Fig. 13/14



1632
Jaquette
Fig. 1



1634
Jaquette
Fig. 3



Bone Currettes

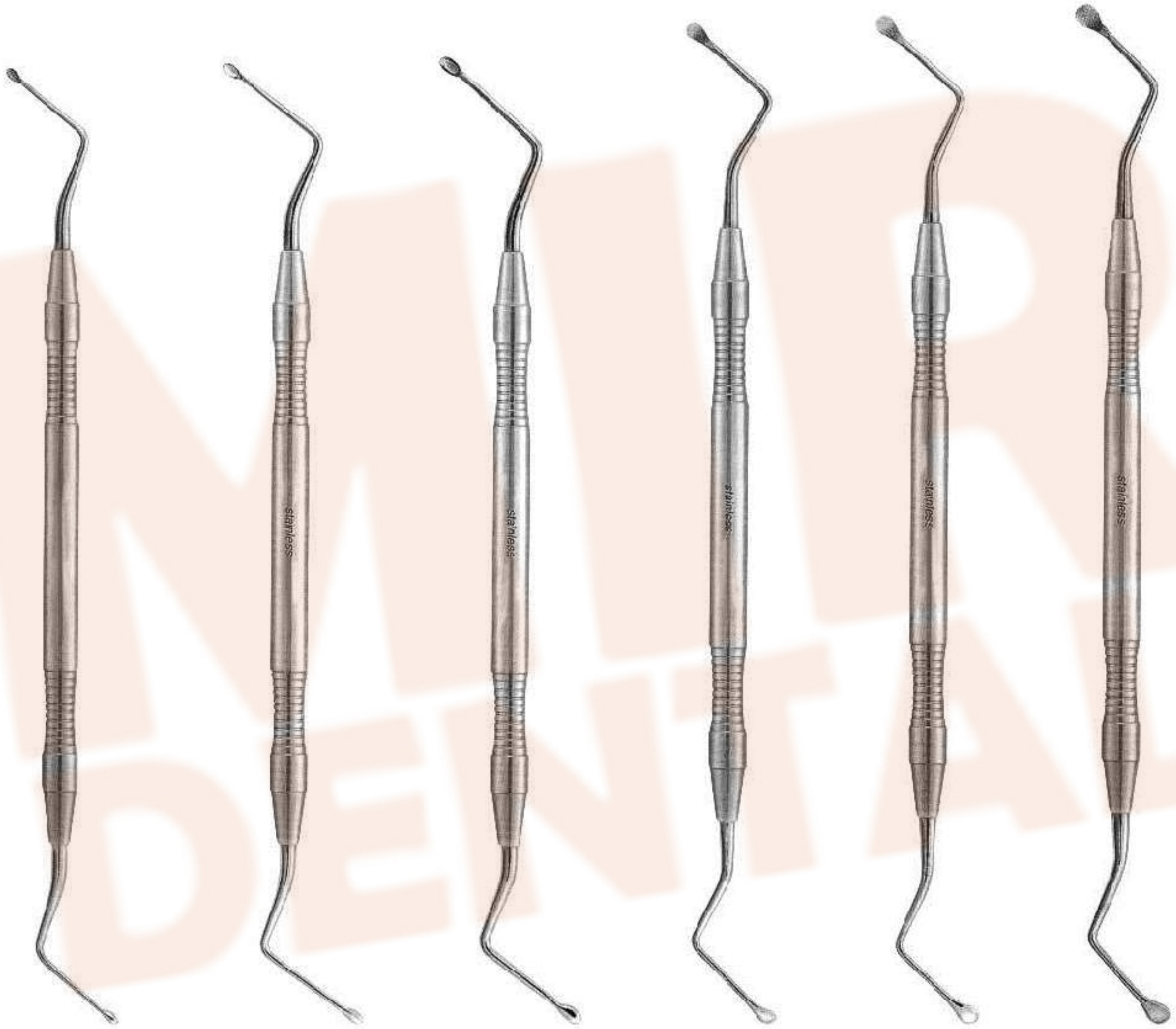

1635
Hemingway
Fig. 1

1636
Hemingway
Fig. 2

1637
Hemingway
Fig. 3

1638
Lucas
Fig. 85

1639
Lucas
Fig. 86

1640
Lucas
Fig. 87



Modelling Instruments

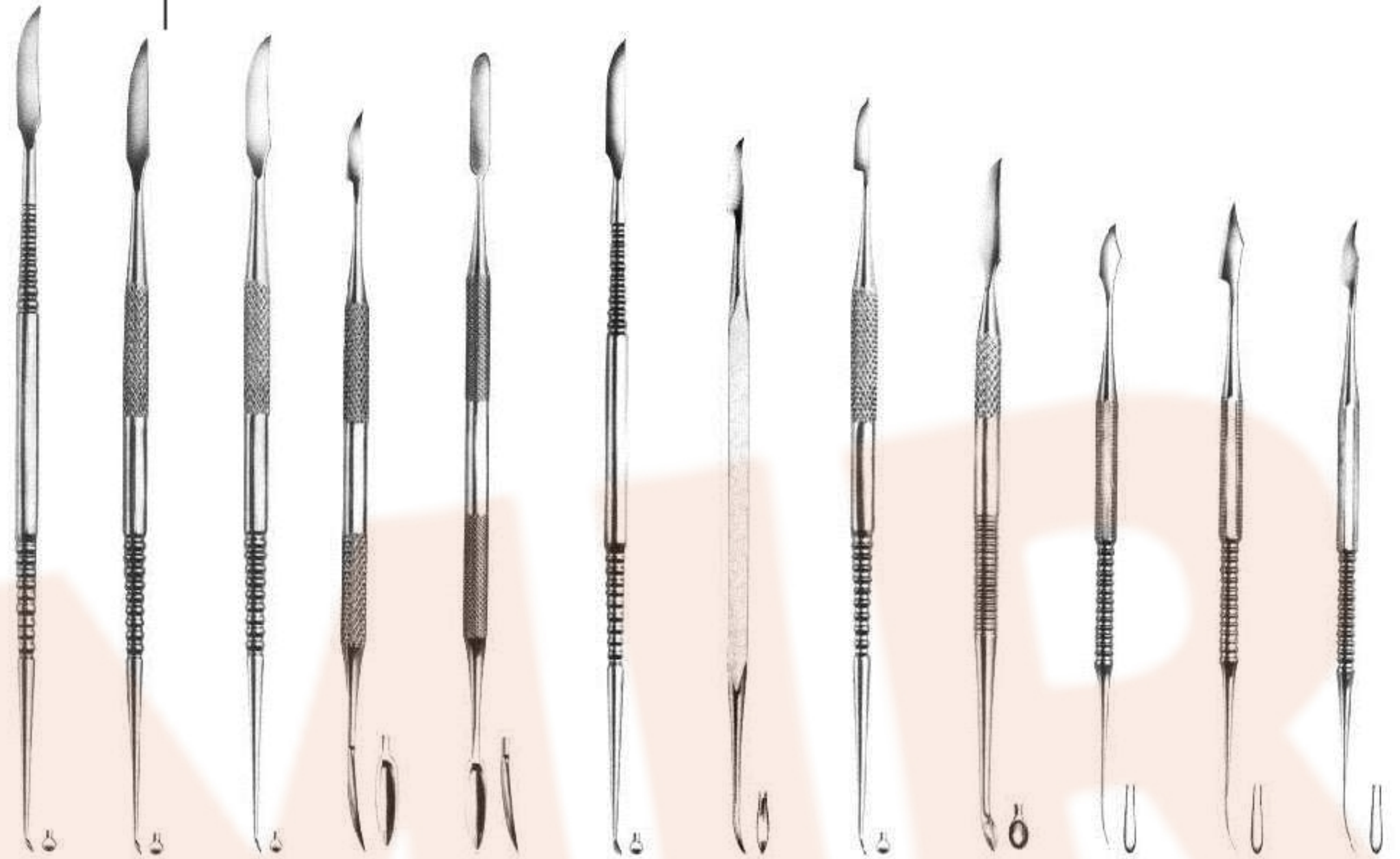

1641 Le Cron	1642 Le Cron	1643 Le Cron	1644 MSY	1645 MSY	1646 Le Cron	1647 Hylin	1648 Hylin	1649 Hylin	1650 Zahle	1651 Zahle	1652 Zahle
------------------------	------------------------	------------------------	--------------------	--------------------	------------------------	----------------------	----------------------	----------------------	----------------------	----------------------	----------------------



1653 Gritman	1654 Beale	1655 Roach	1656 Vehe	1657 P.K. Thomas Fig, 1	1658 P.K. Thomas Fig, 2	1659 P.K. Thomas Fig, 3	1660 P.K. Thomas Fig, 4	1661 P.K. Thomas Fig, 5
------------------------	----------------------	----------------------	---------------------	--------------------------------------	--------------------------------------	--------------------------------------	--------------------------------------	--------------------------------------



Measuring Instruments

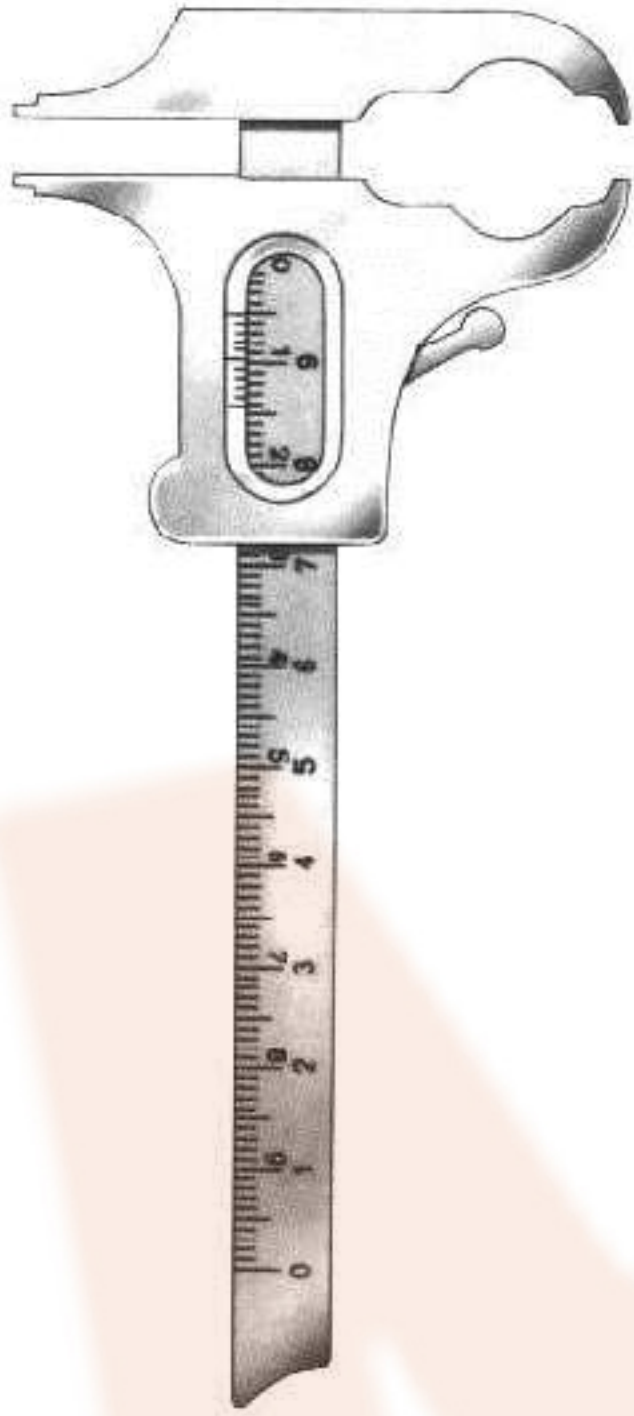

1662
Boley

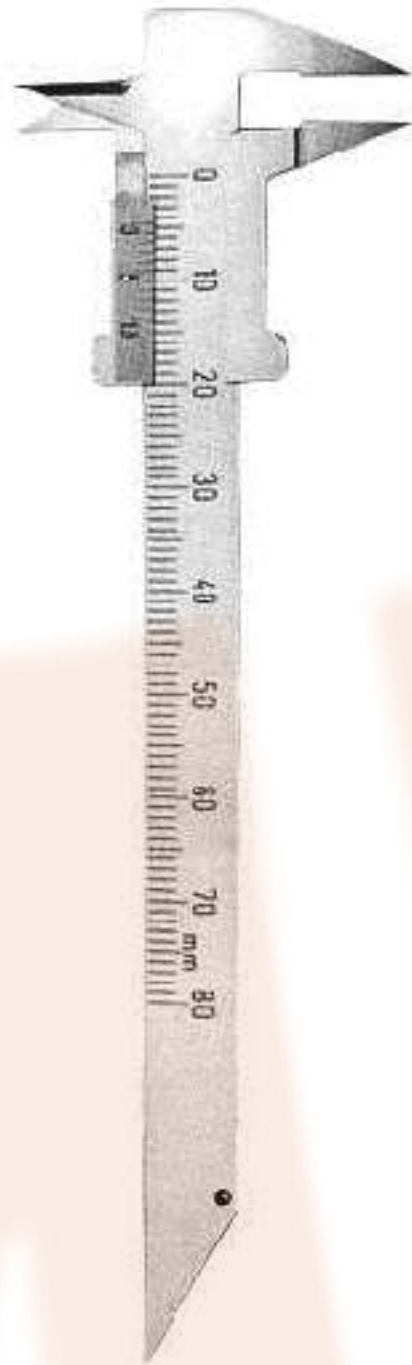

1663
Zuricher
130 mm

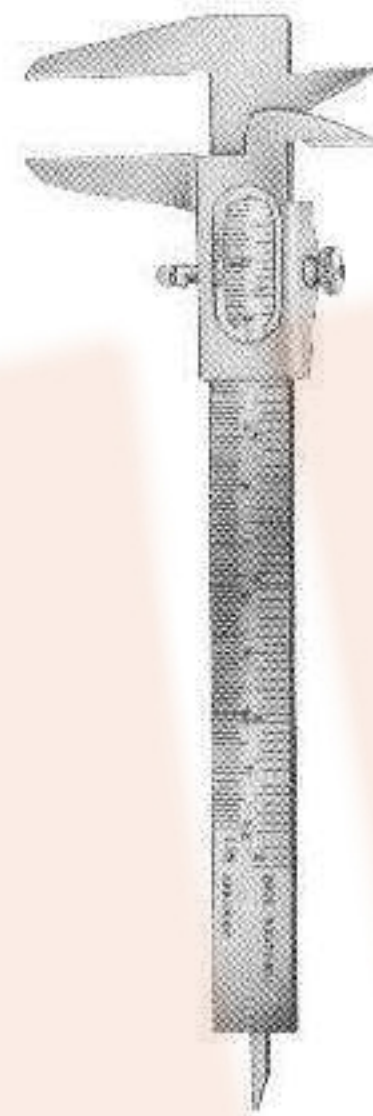

1664
Vernier
12 cm

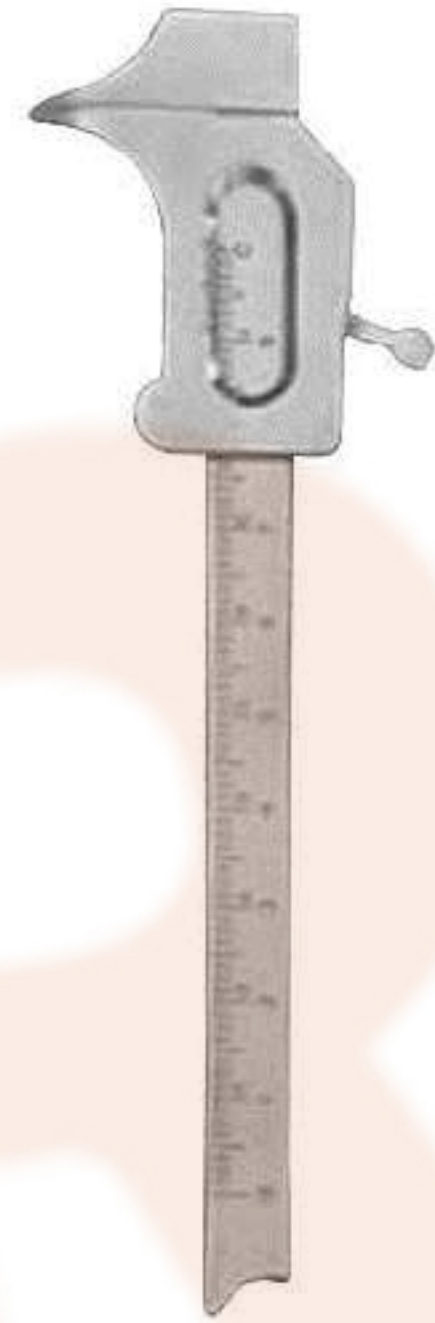

1665
Vernier

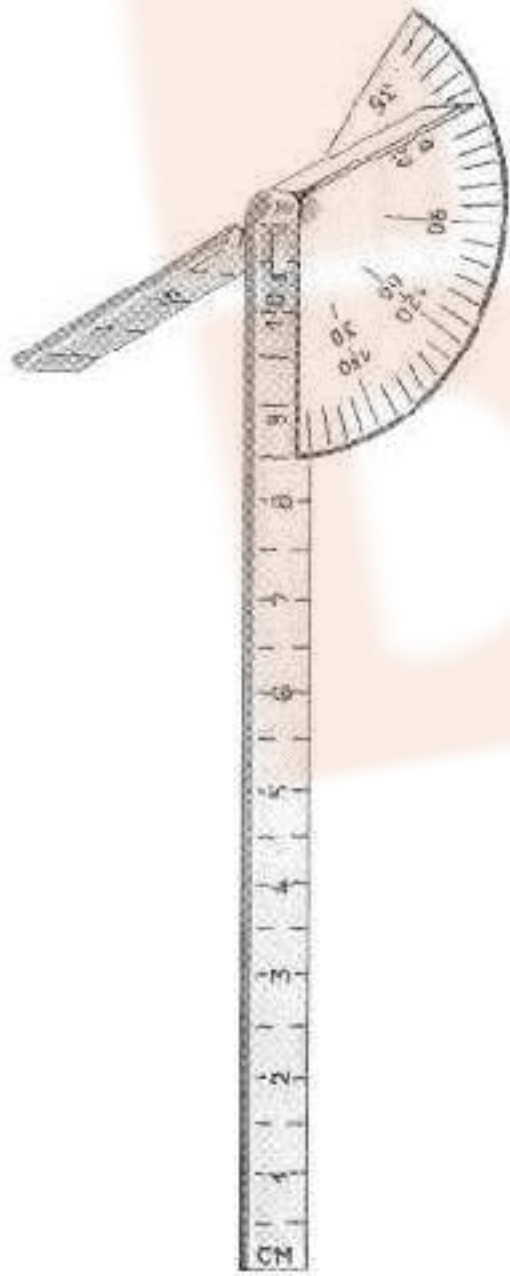

1666
Caroll

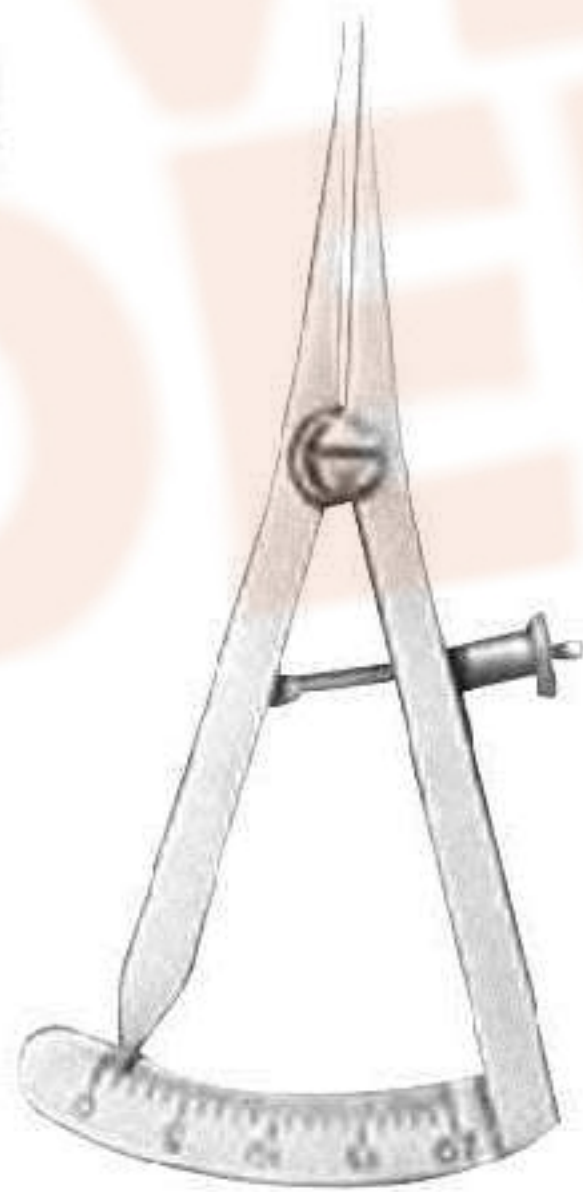

1667
Castroviejo's
Scleral Marker

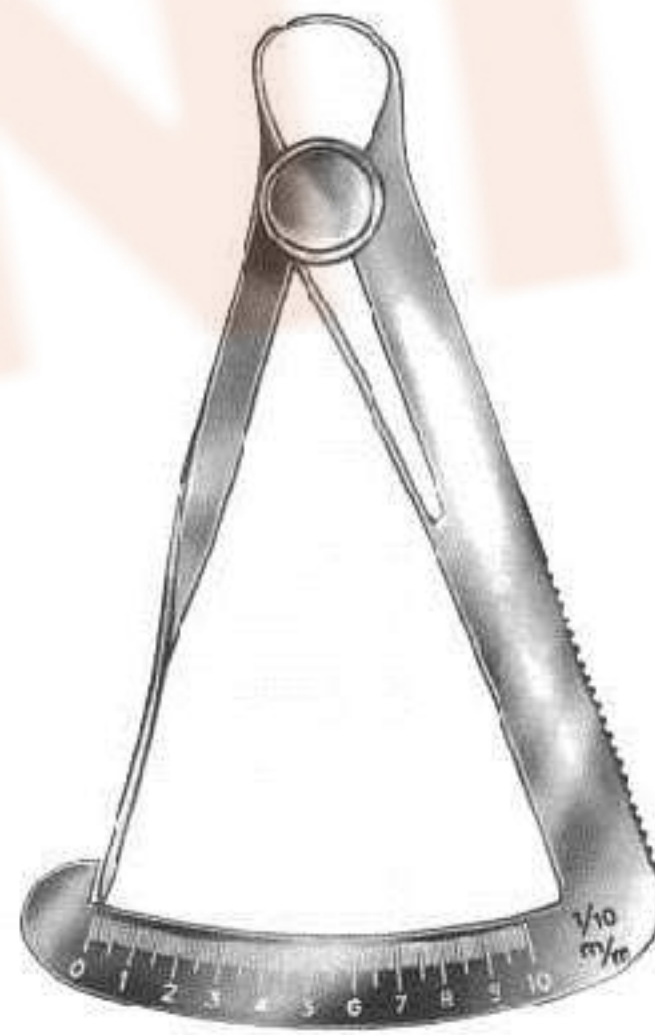

1668
Iwanson

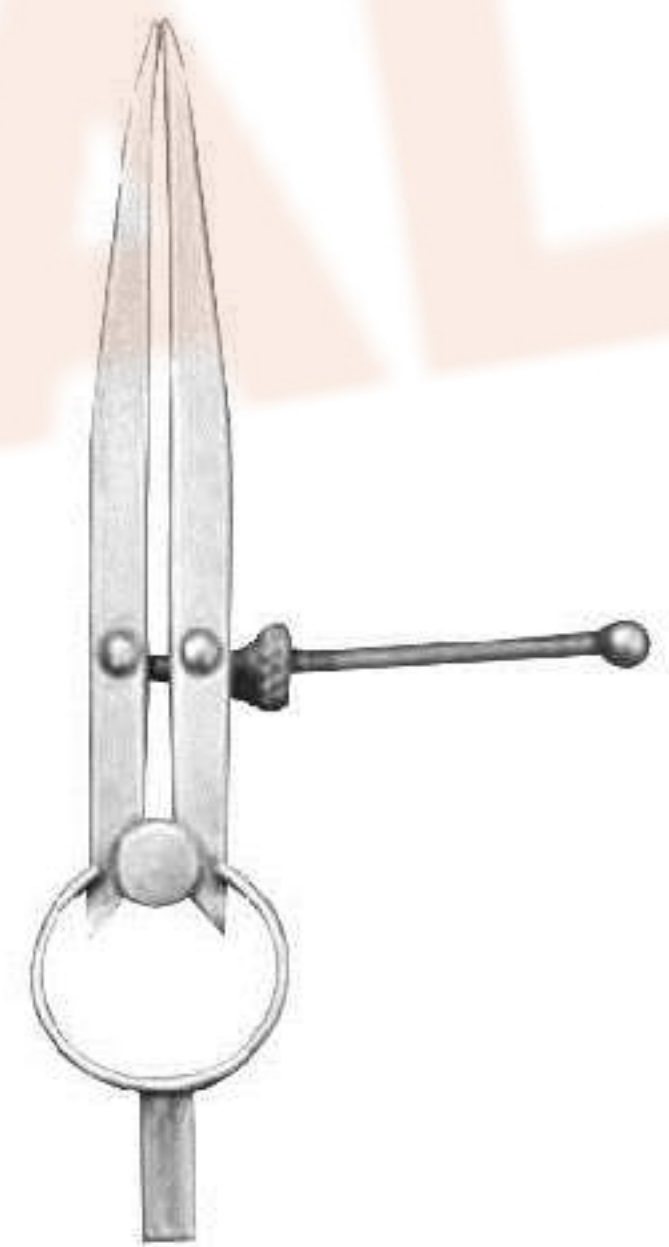

1669
Albee



Modelling Instruments



1700
18 cm
7 1/8"



1701
18 cm
7 1/8"



1702
17 cm
6 3/4"
Gritman



1703
17 cm
6 3/4"
Medicon



1704
22 cm
8 3/4"



1705
Antkoviak



1706
Ermert



1707
Ermert



Wax Knives

MIR
DENTAL



1708
Fahnenstock
Fig, 1
12,5cm

1709
Fahnenstock
Fig, 2
17cm

1710
Lessmann
Fig, 1
12,5cm

1711
Lessmann
Fig, 2
17cm

1712
Con scodellino
Fig, 1
12,5cm

1713
Con scodellino
Fig, 2
17cm



Plaster Knives



1714
Fig, 1
17 cm



1715
Gritman
Fig, 2
17 cm



1716
Fig, 3
16 cm



1717
Fig, 4
16 cm

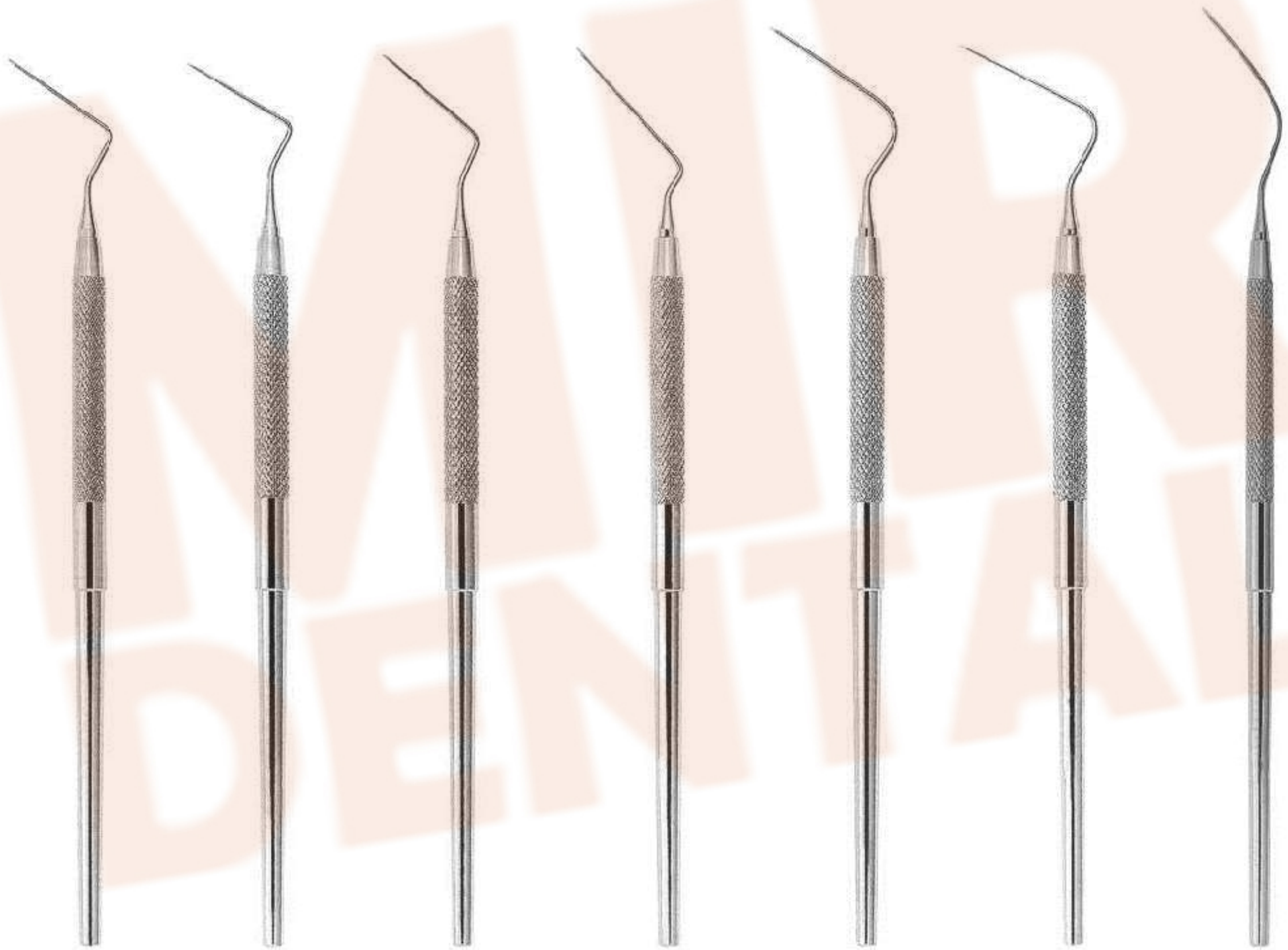

1808
Fig.1
Spreader

1809
Fig.2
Spreader

1810
Fig.3
Spreader

1811
Fig.4
Spreader

1812
Fig.5
Spreader

1813
Fig.6
Spreader

1814
Fig.7
Spreader



Double-Ended Root Canal Explorers Plugger/Spreaders

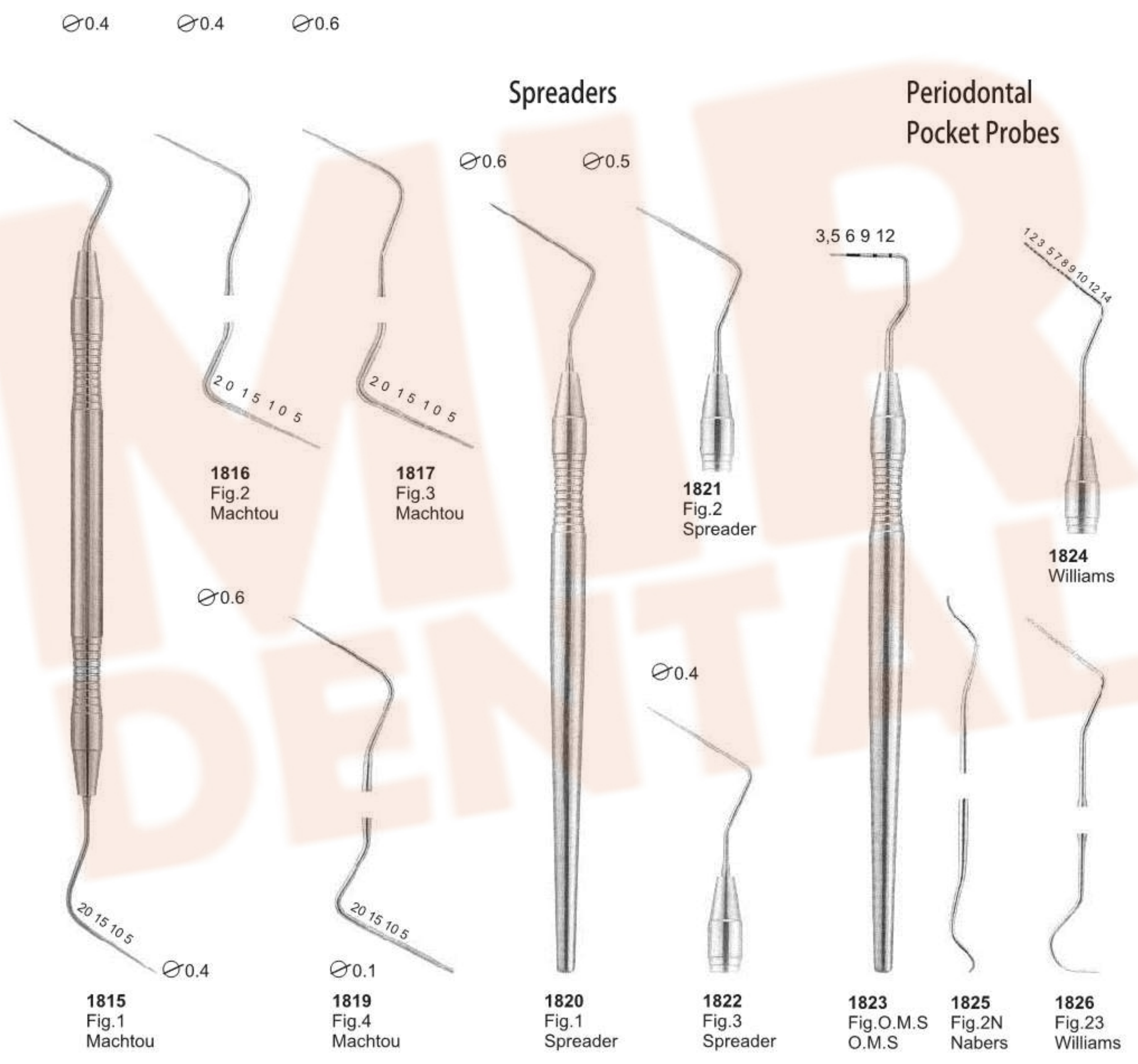



Root-canal pluggers

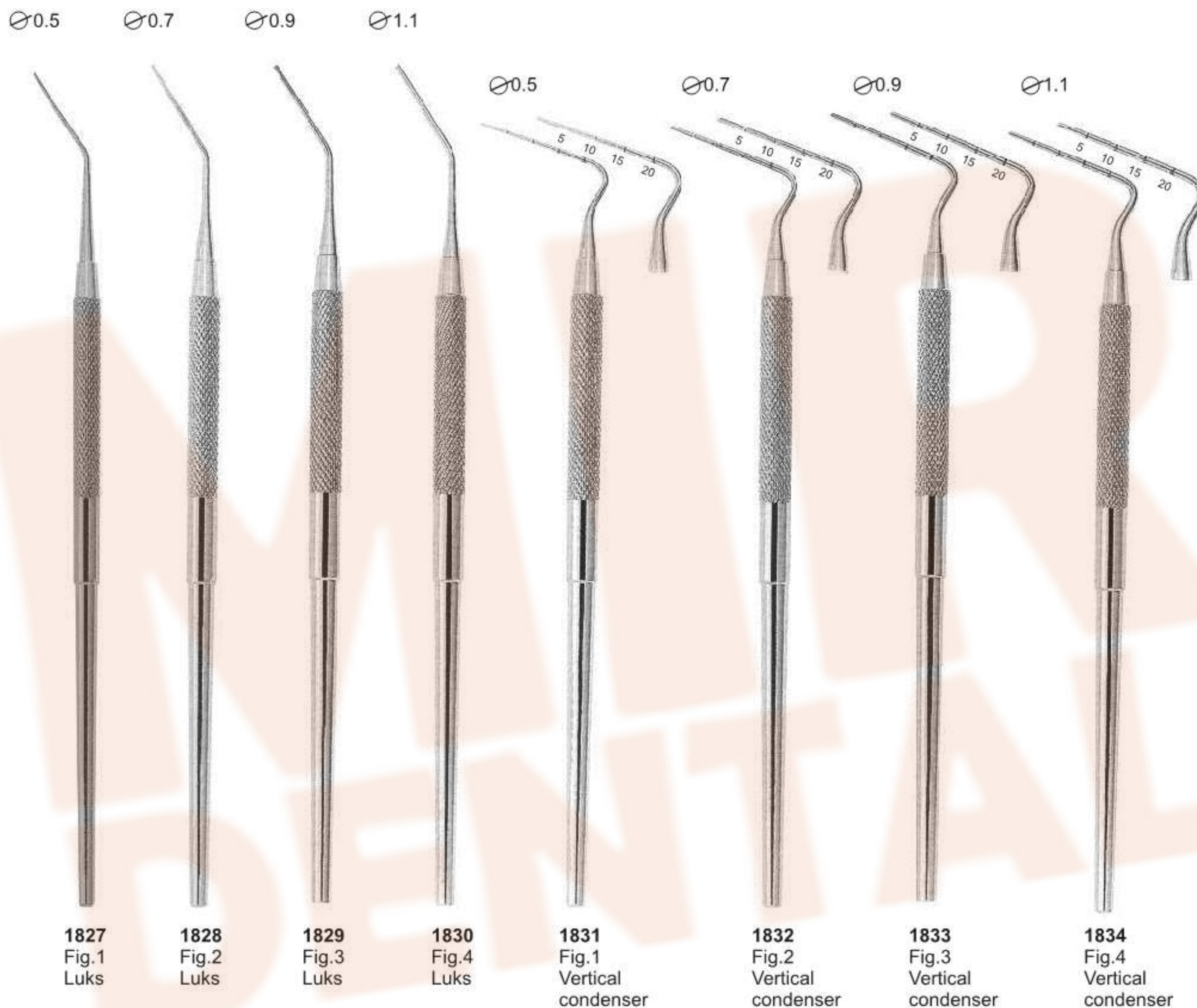

1827
Fig.1
Luks

1828
Fig.2
Luks

1829
Fig.3
Luks

1830
Fig.4
Luks

1831
Fig.1
Vertical
condenser

1832
Fig.2
Vertical
condenser

1833
Fig.3
Vertical
condenser

1834
Fig.4
Vertical
condenser

Endodontic set

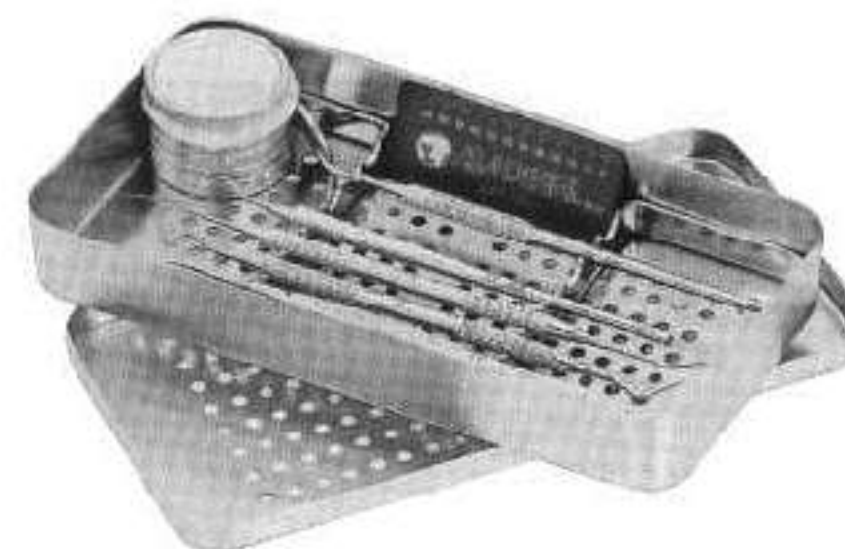

1835
Measuring Plate



Root-canal pluggers

Optimum Flexibility
Very Fine Points

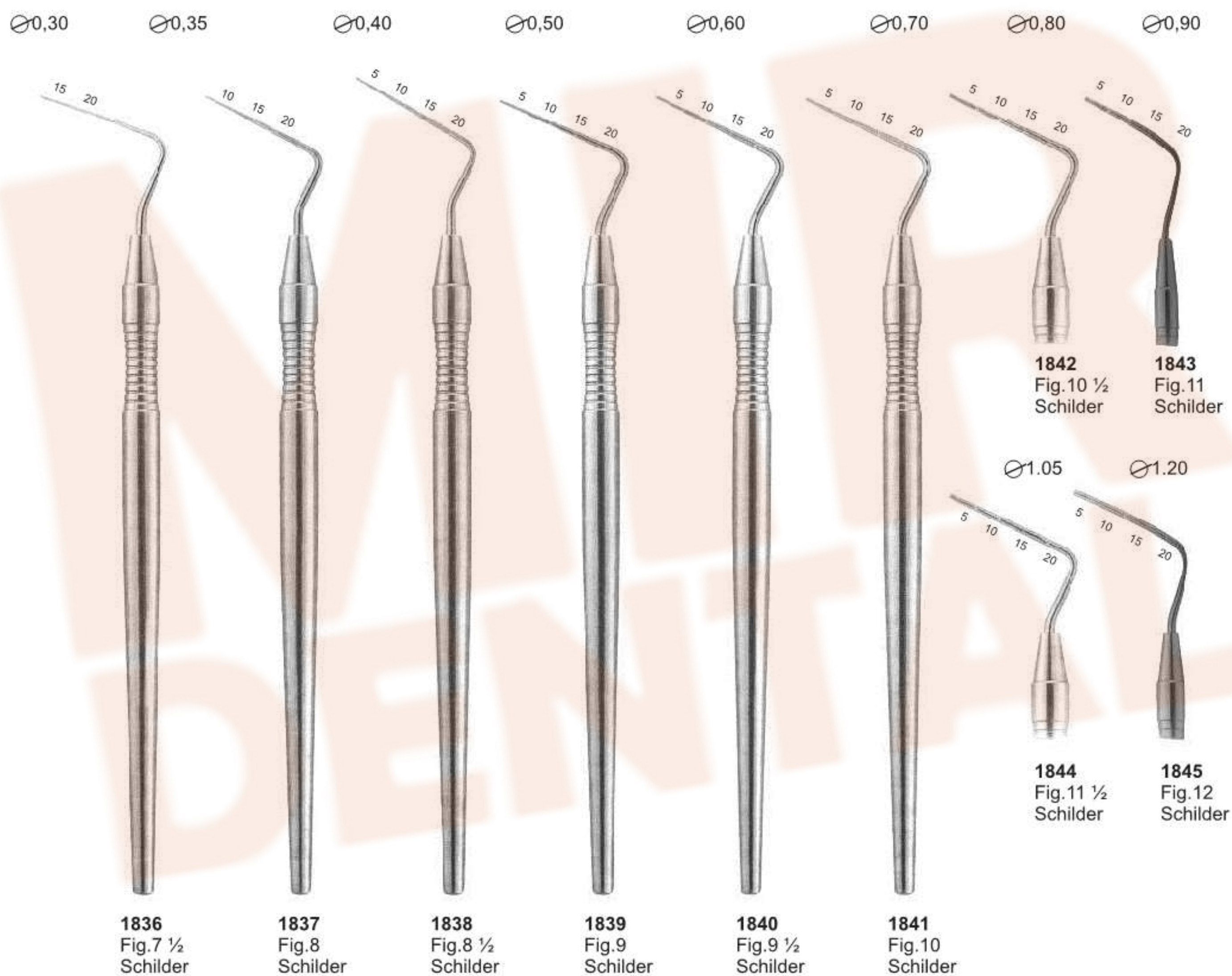



Root-canal explorers

Root-canal excavators



1846
Fig.6/1



1847
Fig.6/17

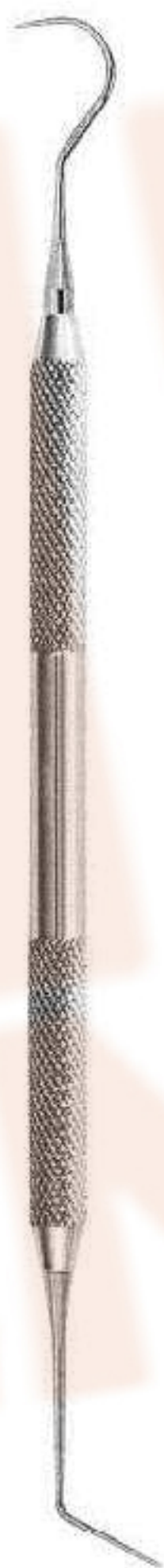

1848
Fig.6/23



1849
Fig.31L



1850
Fig.32L



1851
Fig.33L



Excavators

1 mm



1852
Fig 5

1.2 mm

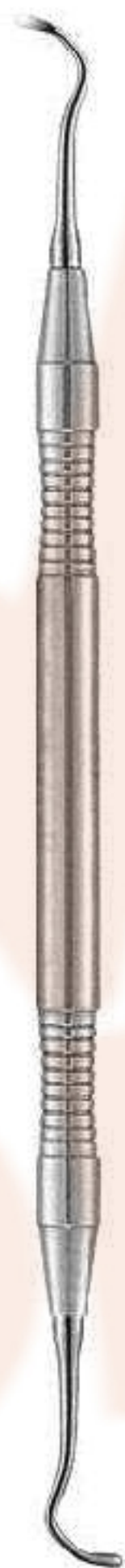

1853
Fig 14

1 mm



1854
Fig 17

1.2 mm



1855
Fig 18

1.6 mm



1856
Fig 19

2 mm



1857
Fig 20



Excavators

1 mm



1858
ASH
Fig.243

1,4 mm



1859
ASH
Fig.G2

0,8 mm



1860
Fig.1

0,8 mm



1861
Fig.2

1 mm



1862
Fig.11

1 mm



1863
Fig.12

1,2 mm



1864
Fig.21

1,2 mm



1865
Fig.22

1,6 mm



1866
Fig.31

1,6 mm



1867
Fig.32

2 mm



1868
Fig.41

2 mm



1869
Fig.42



Handles for Mouth Mirrors and Mouth Mirrors

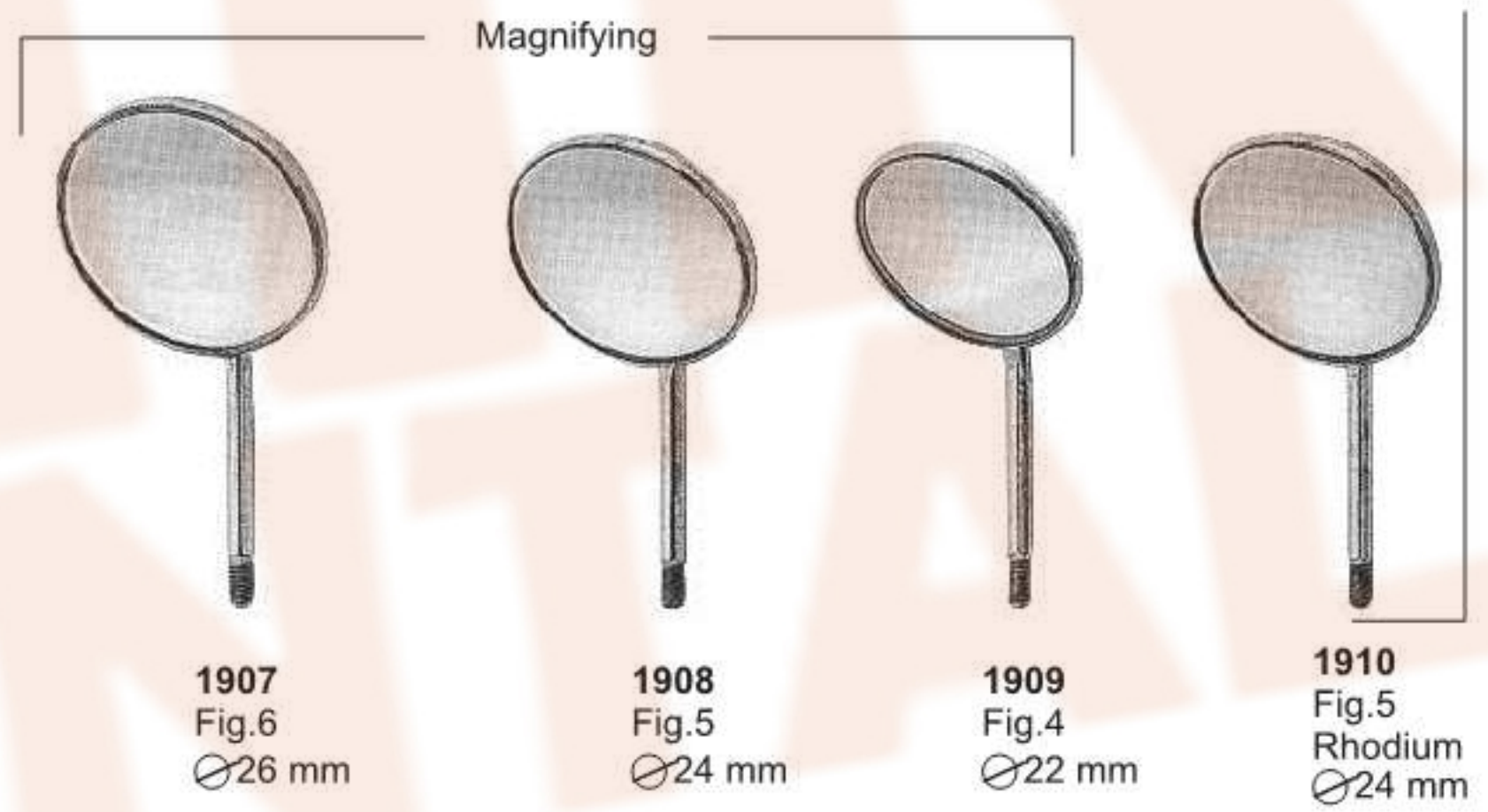
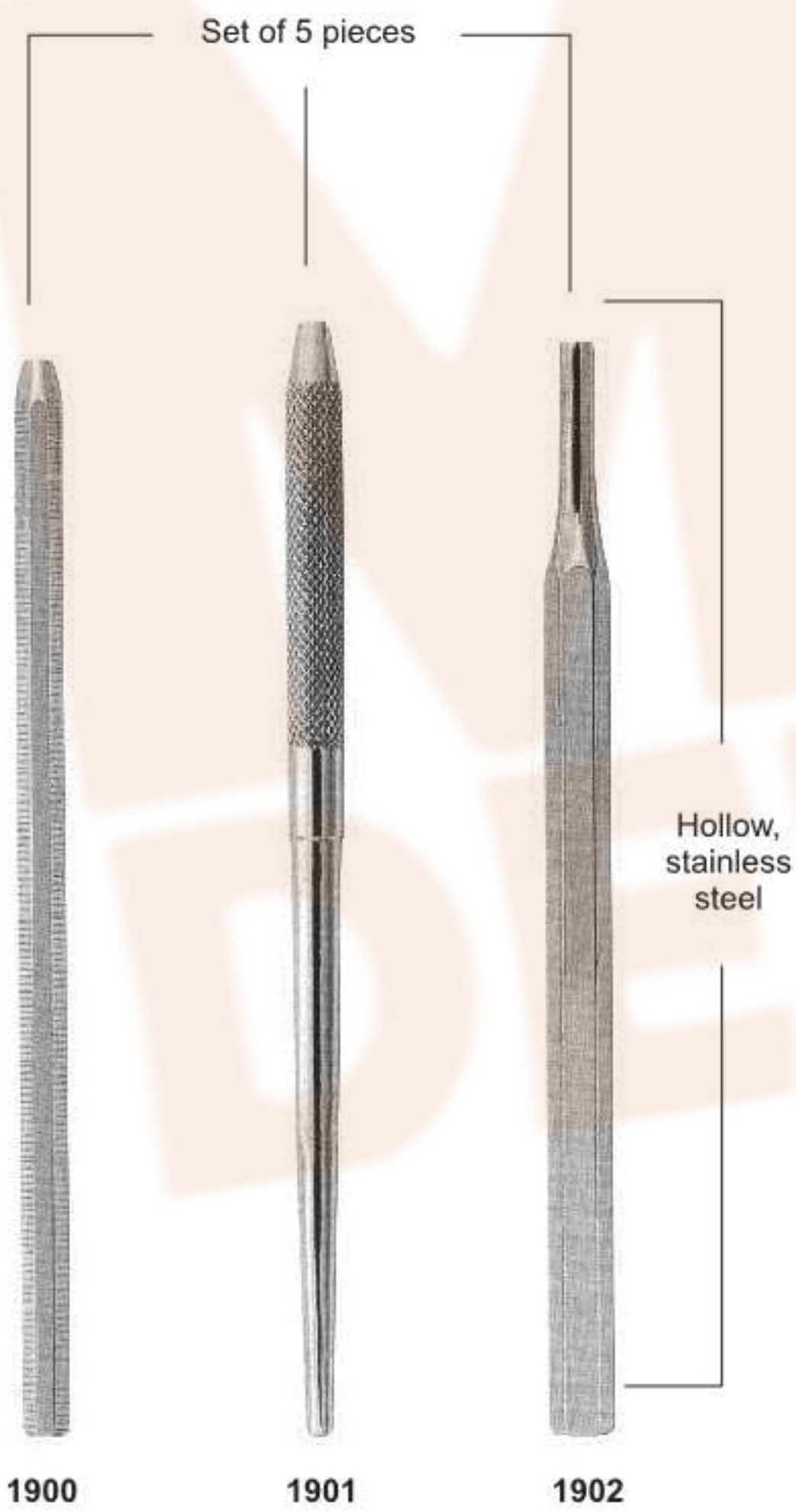
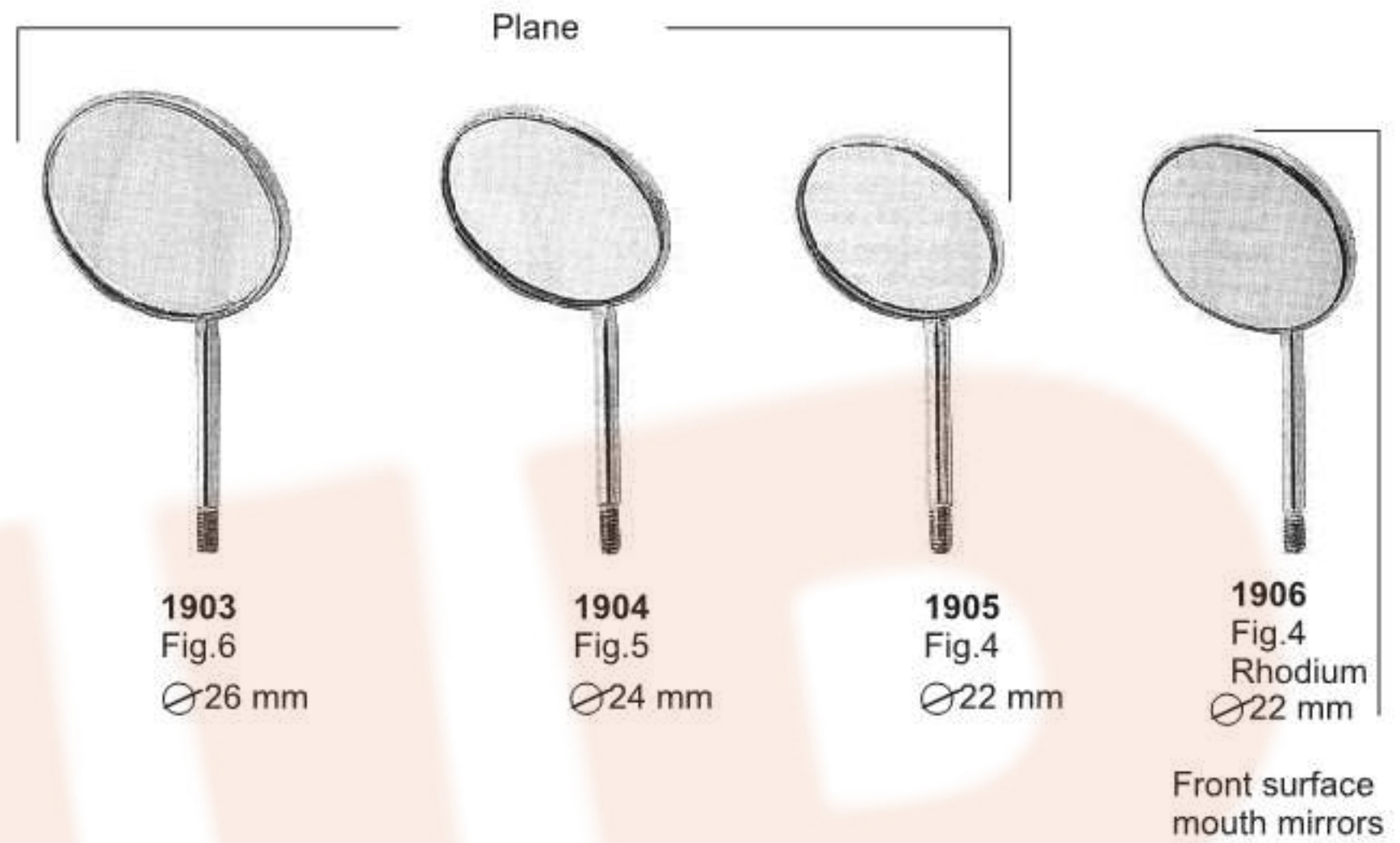



Handles for Mouth Mirrors and Mouth Mirrors



1911



1912



1913



1914



1915



1916
Parallelometer
mouth mirror



1917
Parallelometer
mouth mirror
+ handle
code 2101

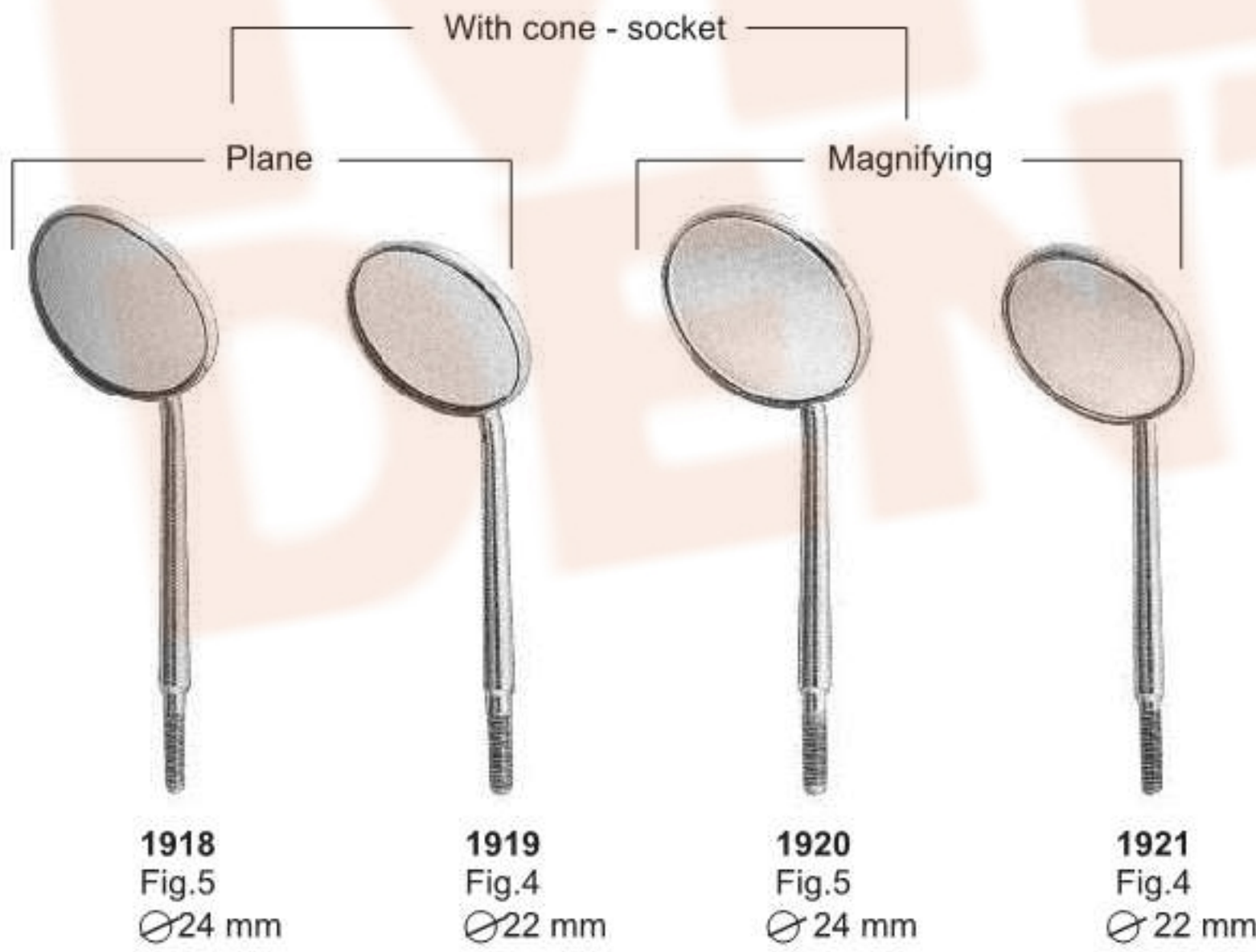

1922
Cone - socket



1923
Cone - socket



1924
Cone - socket



Cement Spatulas



2000



2001



2002



2003

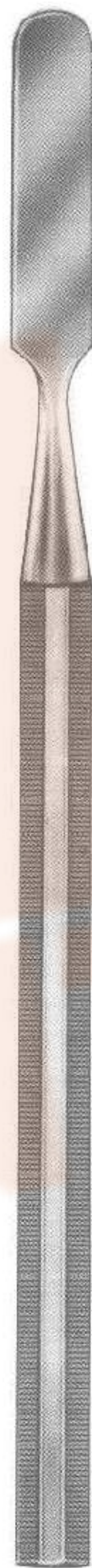

2004



2005



2006



2007



Cement Spatulas

MIR
DENTAL



2008

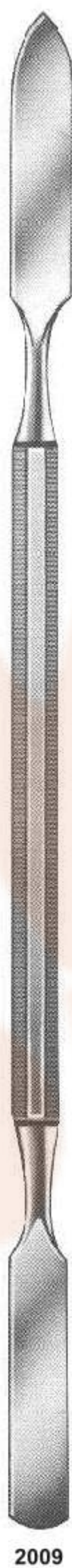

2009



2010



2011



2012



2013



2014



Spatulas for Plaster and Alginate

Rigid



2100
Fig. 1
18.5 cm



2121
Fig. 2
18 cm



2122
Fig. 3
18.5 cm



2123
Fig. 4
19.5 cm



2124
Fig. 5
21.5 cm



2125
Fig. 6
20.5 cm

Flexible



Spatulas for Plaster and Alginate

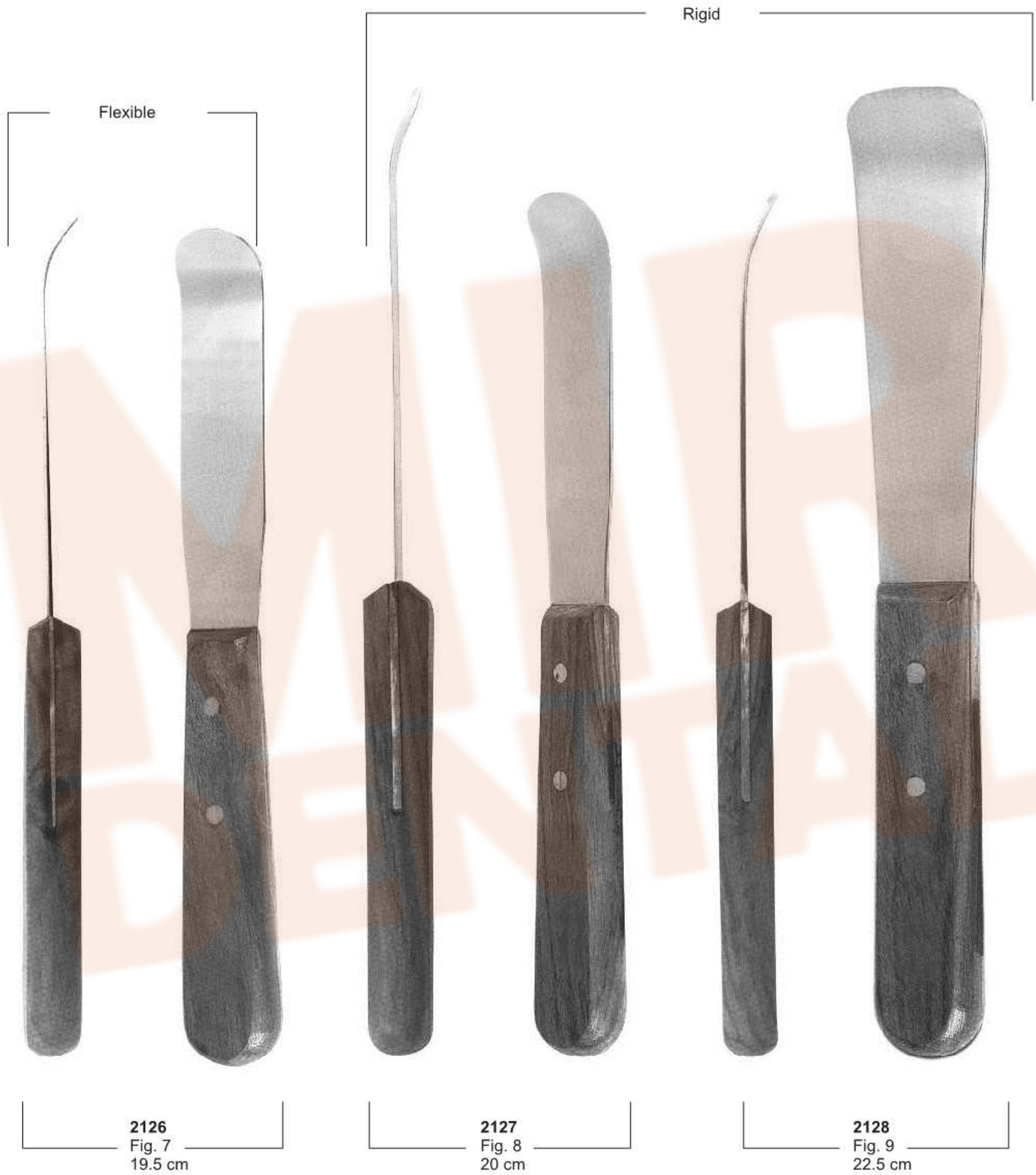

Flexible

Rigid

2126
Fig. 7
19.5 cm

2127
Fig. 8
20 cm

2128
Fig. 9
22.5 cm



Needle Holders

MIR
DENTAL



2200
Mayo-Hegar
16 cm

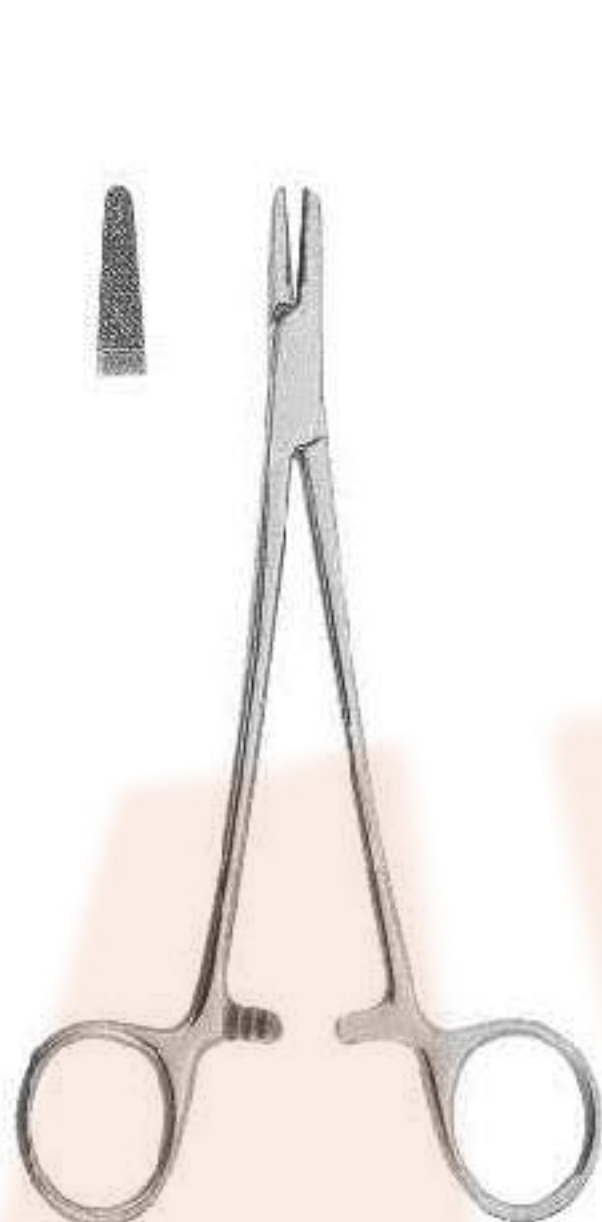

2201
Mayo-Hegar TC
16 cm

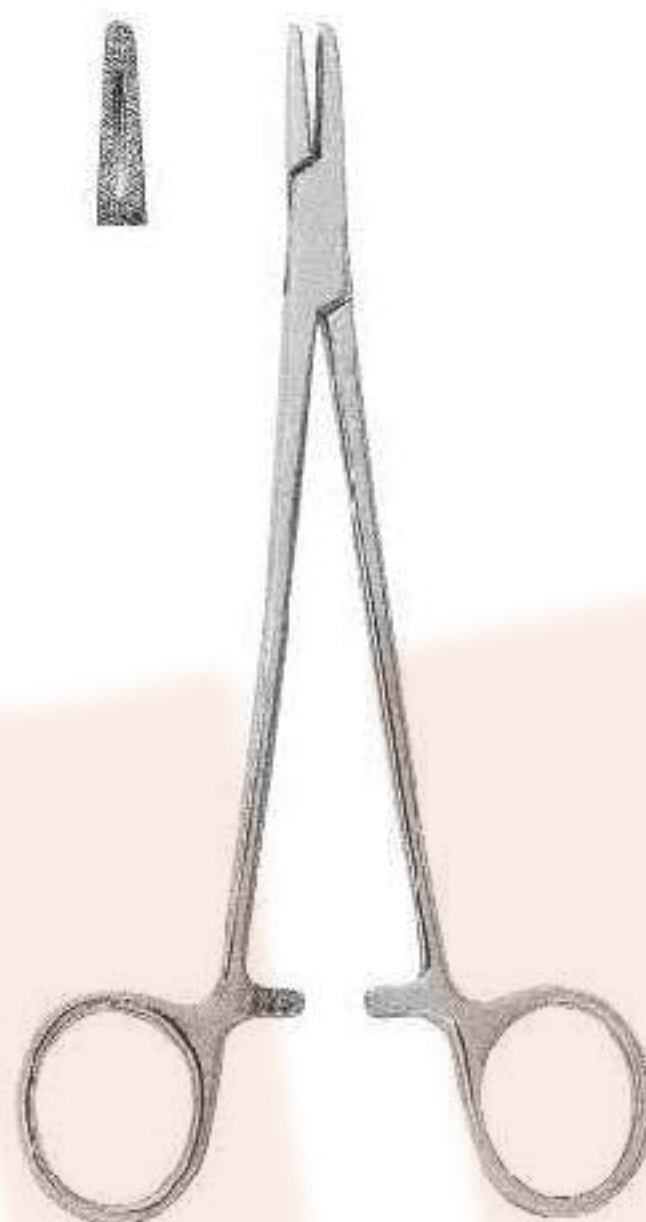

2202
Mayo-Hegar
18 cm

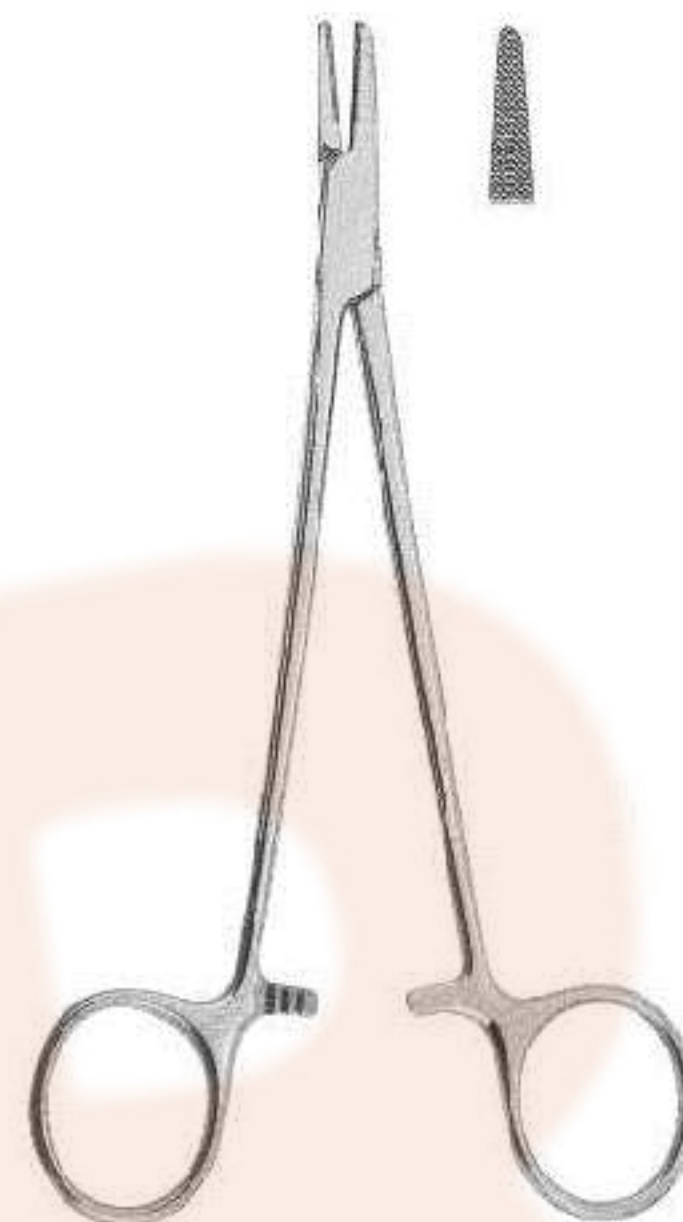

2203
Mayo-Hegar TC
18 cm

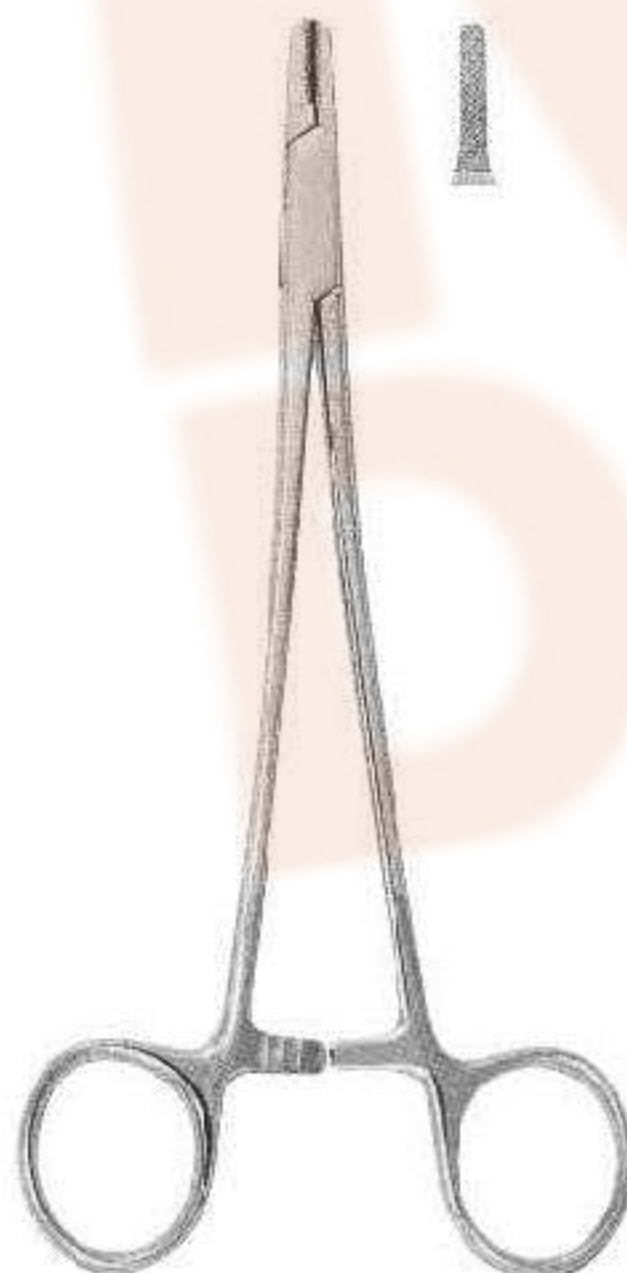

2204
Mini-Ryder
18 cm

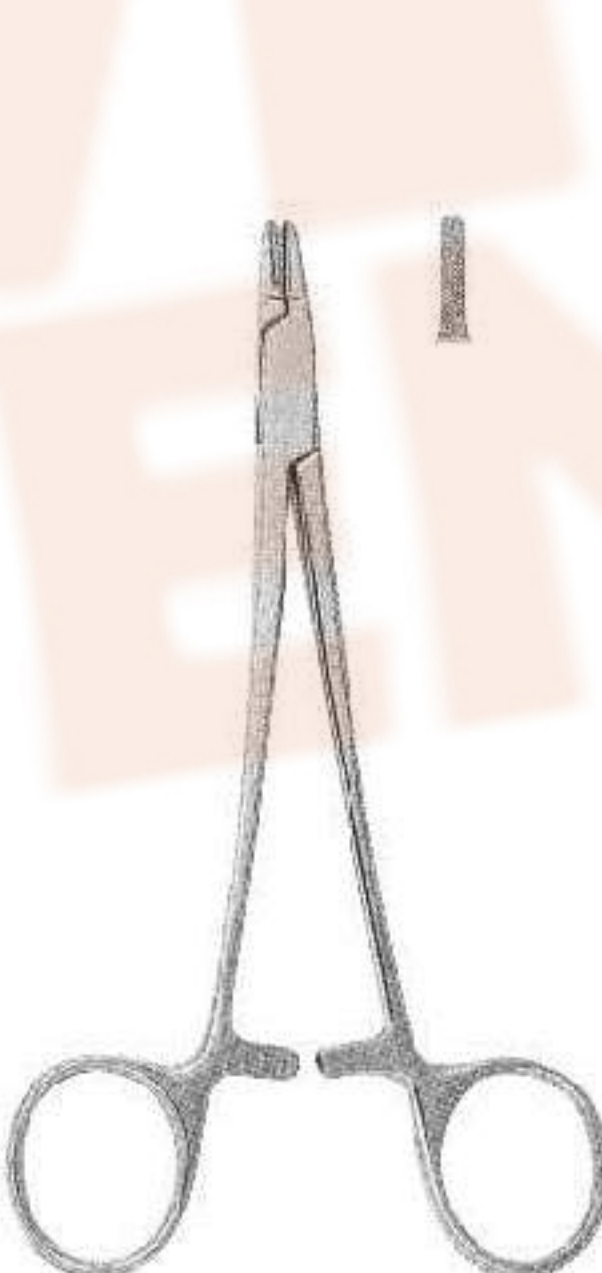

2205
Mini-Ryder
15 cm

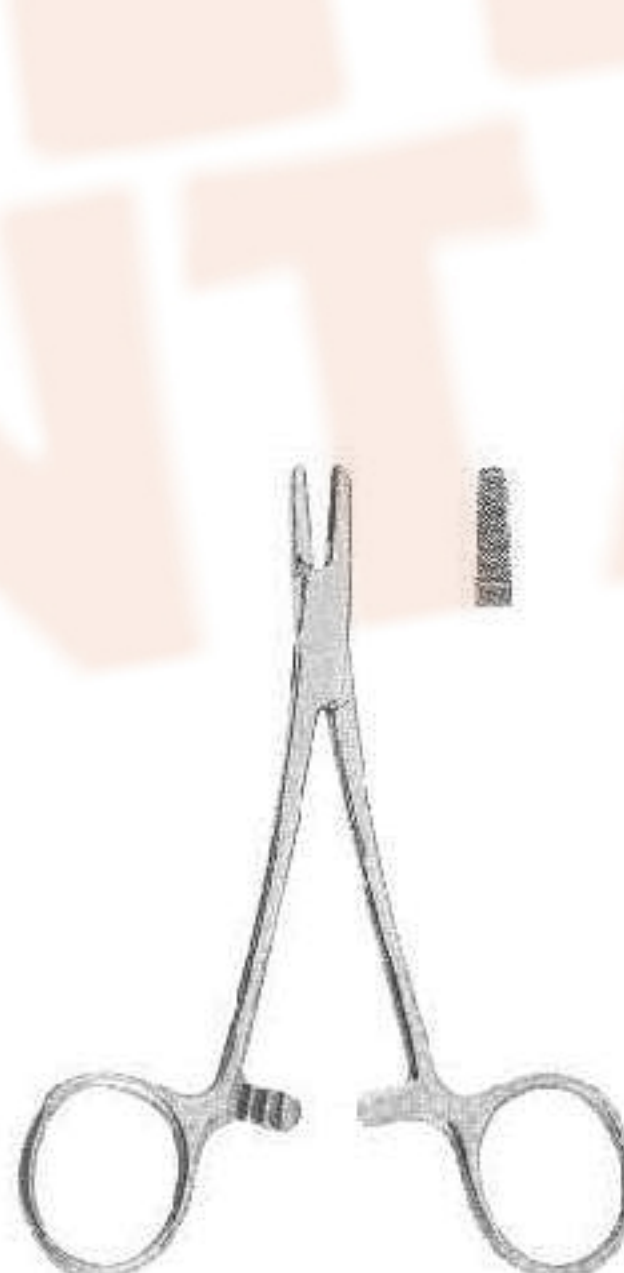

2206
Derf
12 cm

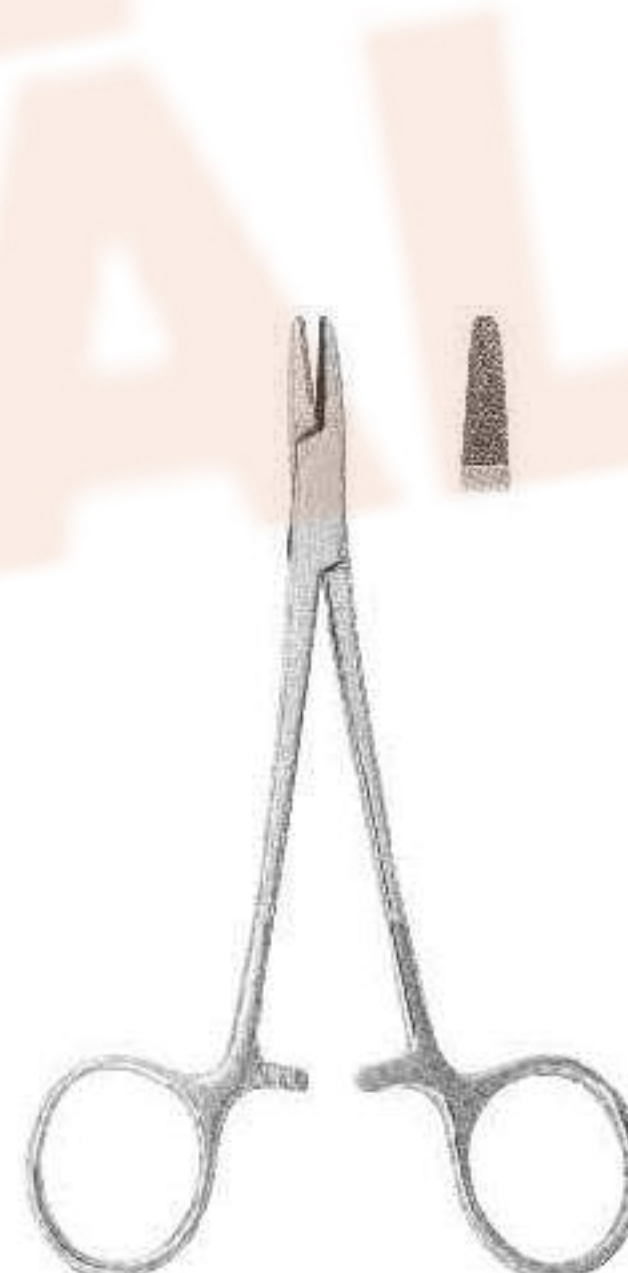

2207
Hegar-Baumgarther
14 cm



Needle Holders

MIR
DENTAL



2208
Crile-Wood
15 cm

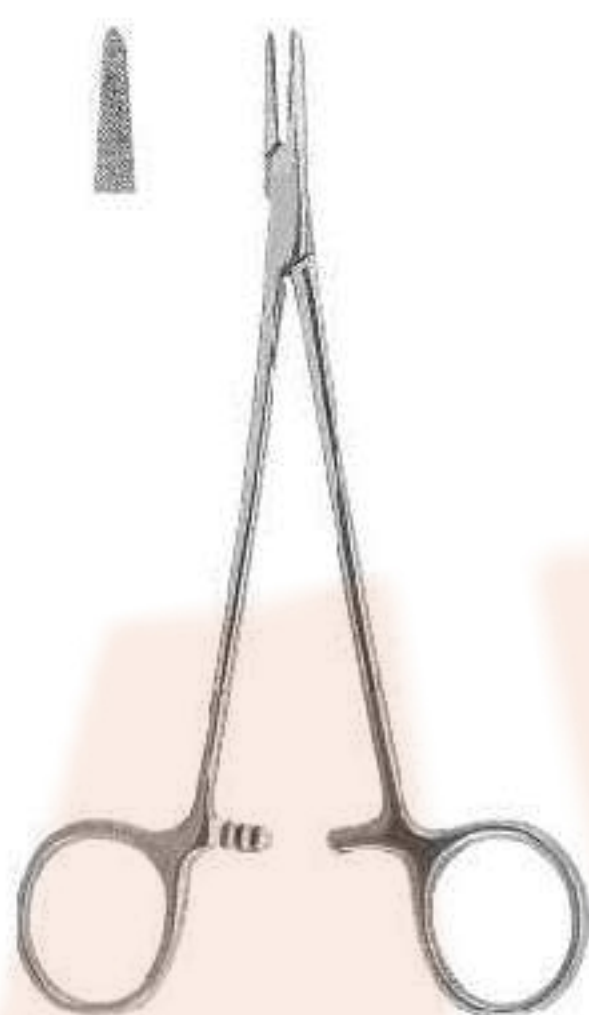

2209
Crile-Wood TC
15 cm

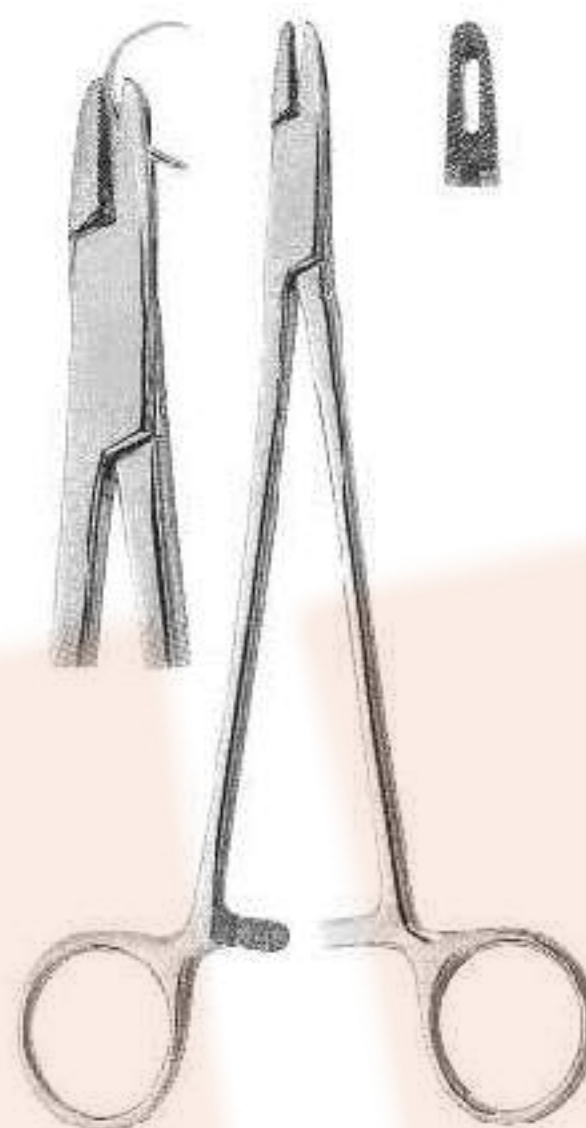

2210
Adson
17.5 cm



2211
Olsen-Hegar
14 cm

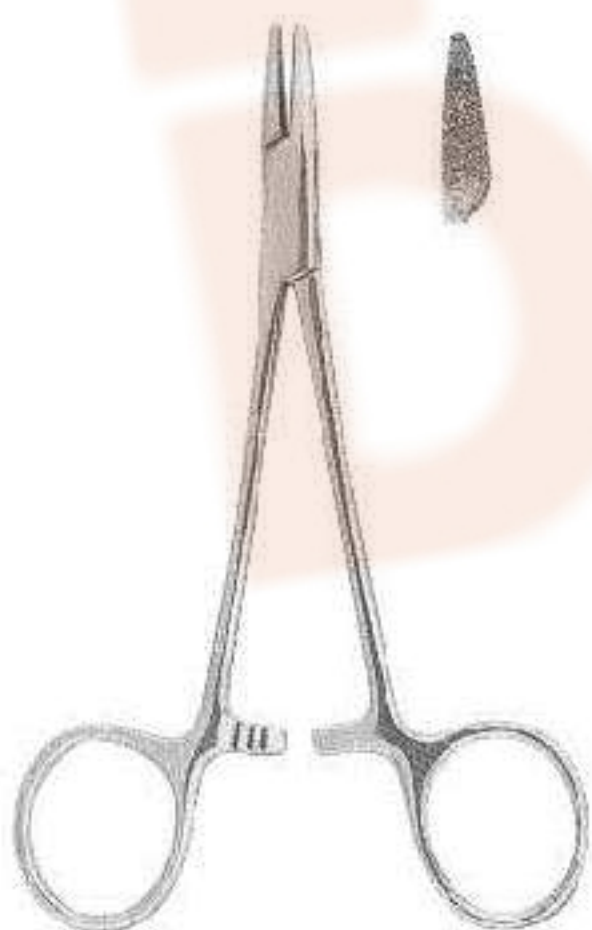

2212
Baumgarther
14.5 cm



2213
Gillies
16 cm



2214
Gillies
16 cm

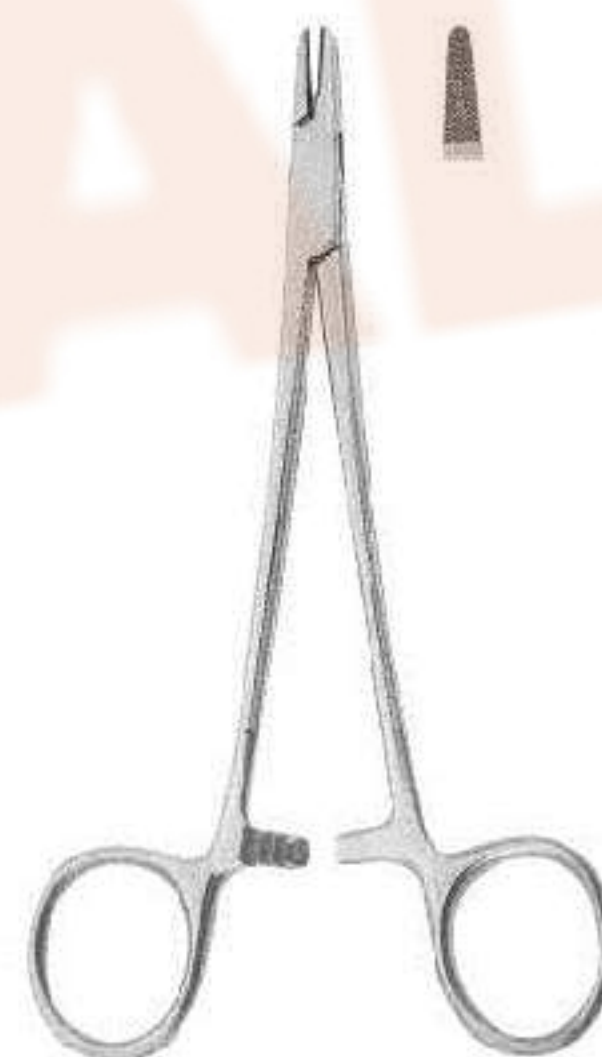

2215
Hegar-Baumgarther
14 cm



Needle Holders



2216
Toennis
18 cm



2217
Toennis
18 cm

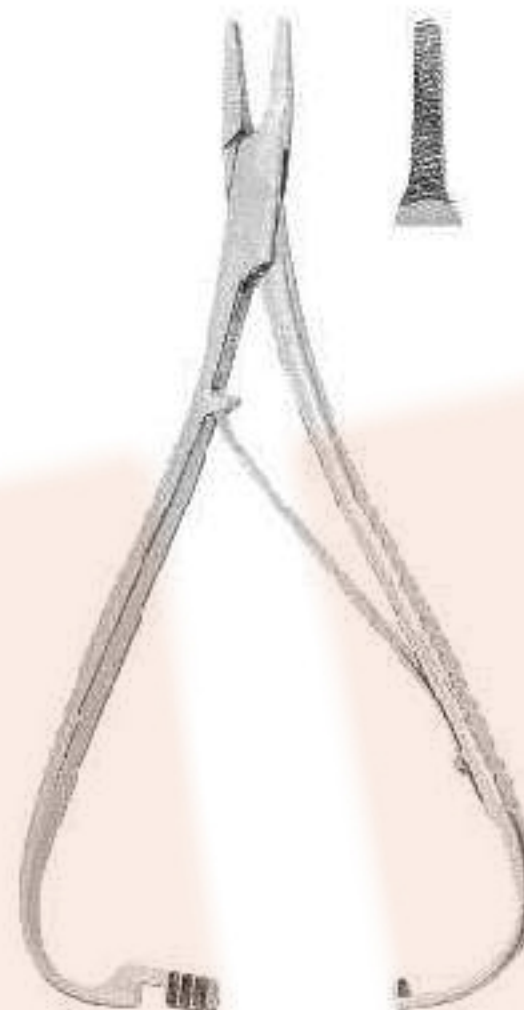

2218
Lichtenberg
17 cm

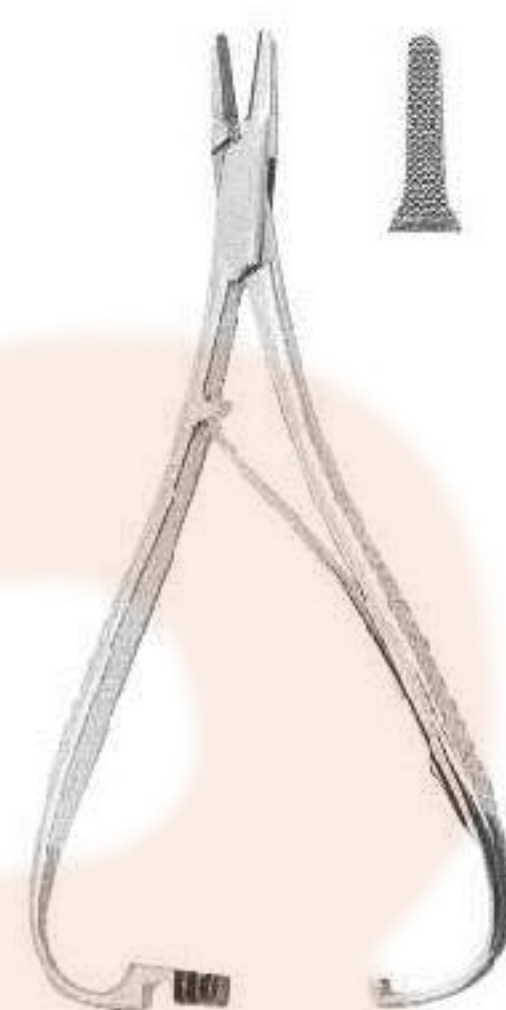

2219
Lichtenberg
17 cm

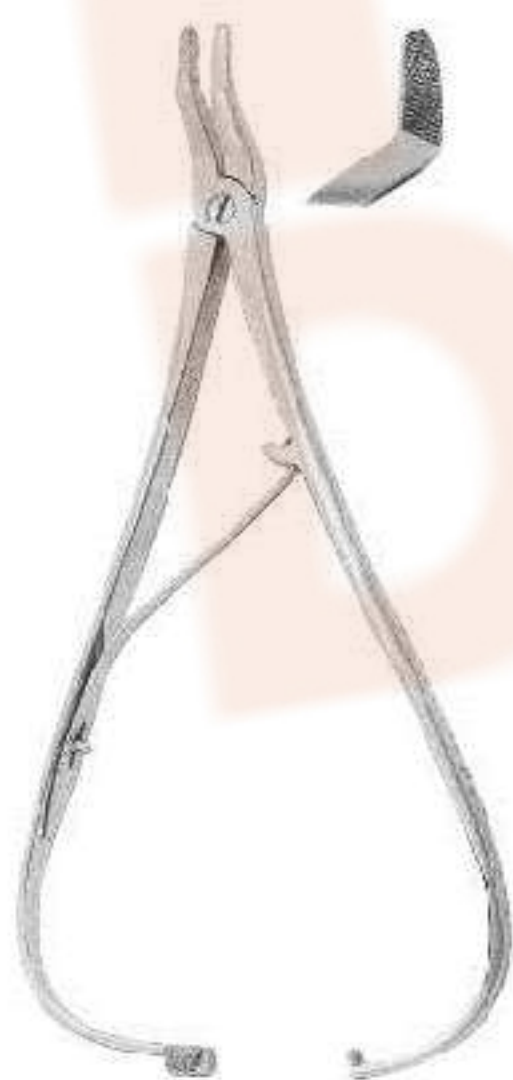

2220
Eiselberg-Mathieu
19.5 cm

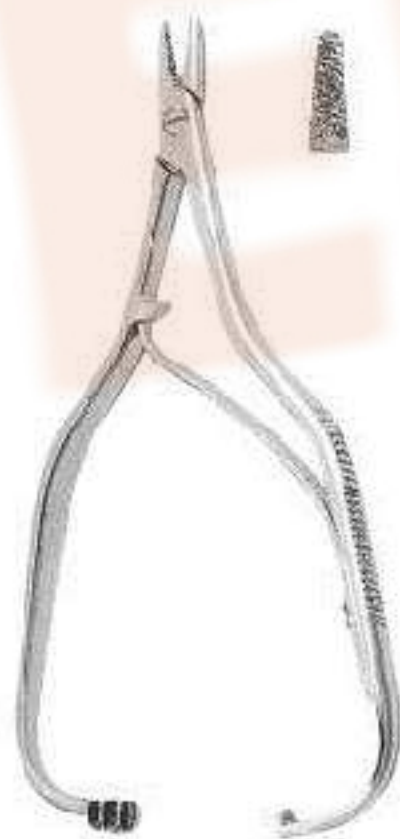

2221
Boynton
12 cm

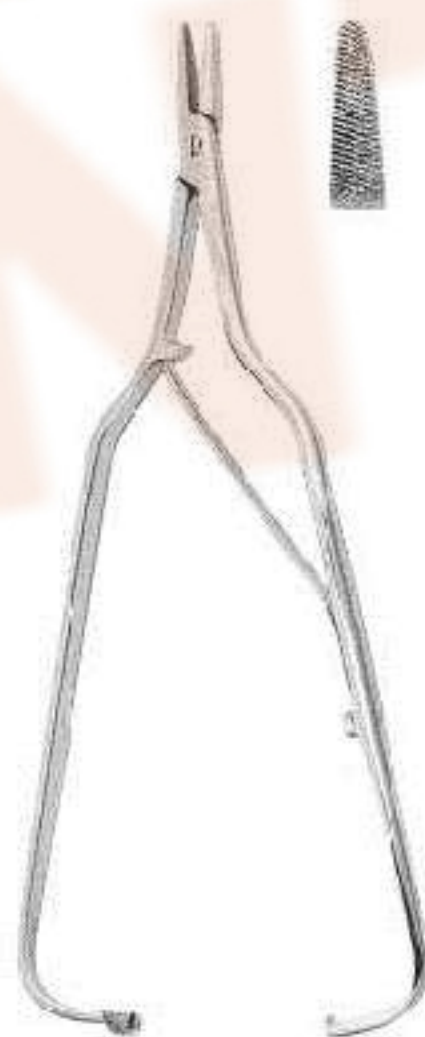

2222
Arruga
16 cm



2223
Boynton
12 cm



2224
Arruga
16 cm



Needle Holders



2225
Castroviejo
14 cm



2226
Castroviejo
14 cm

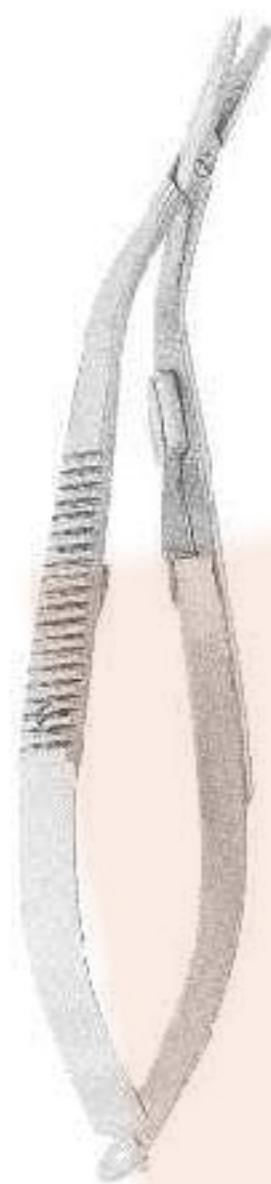

2227
Castroviejo
14/60 cm

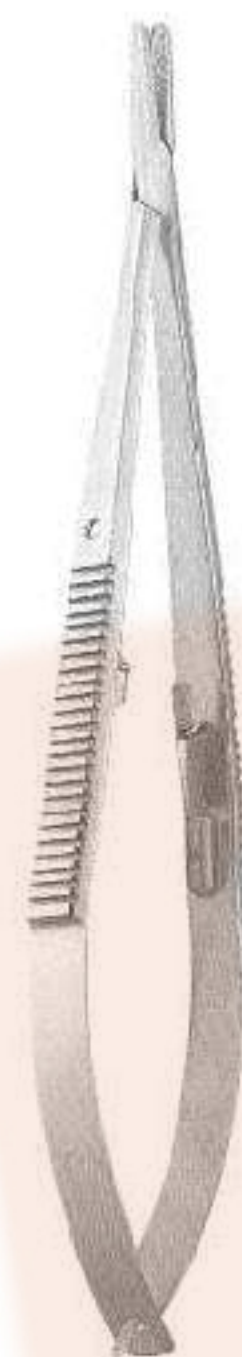

2228
Castroviejo
18 cm



2229
Castroviejo
18 cm



2230
Castroviejo
14 cm

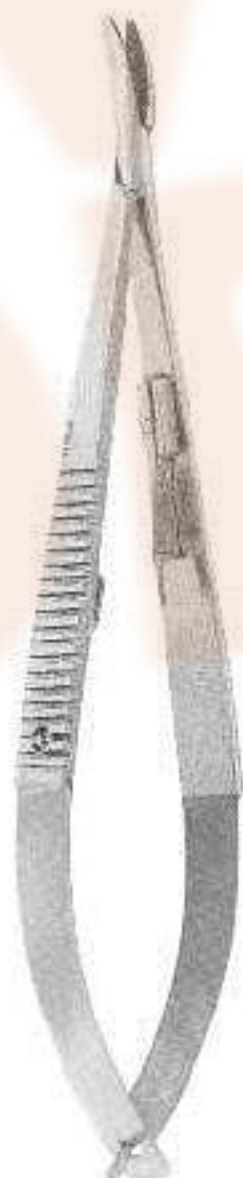

2231
Castroviejo
14 cm



2232
Castroviejo
14/60 cm



2233
Castroviejo
18 cm



2234
Castroviejo
18 cm



Needle Holders

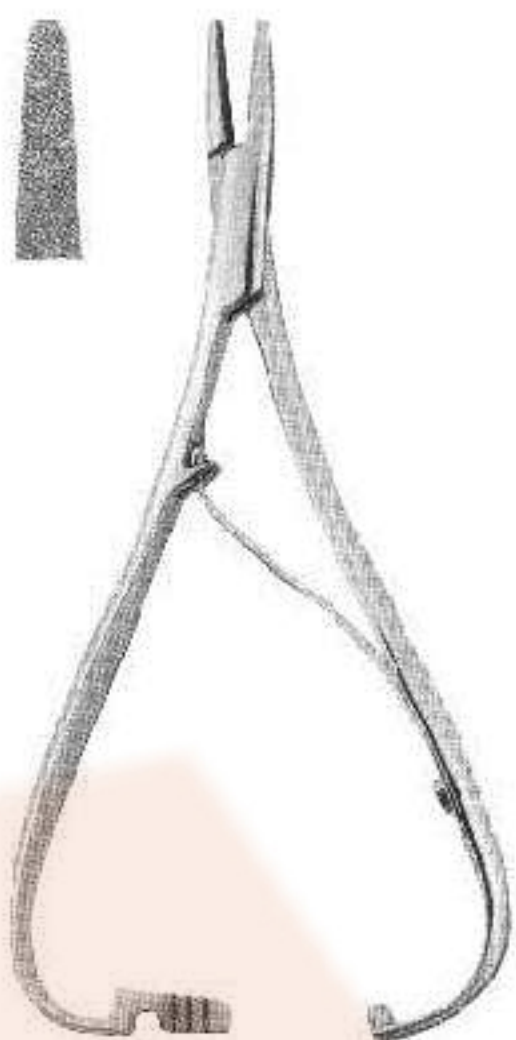

2235
Mathieu
14 cm

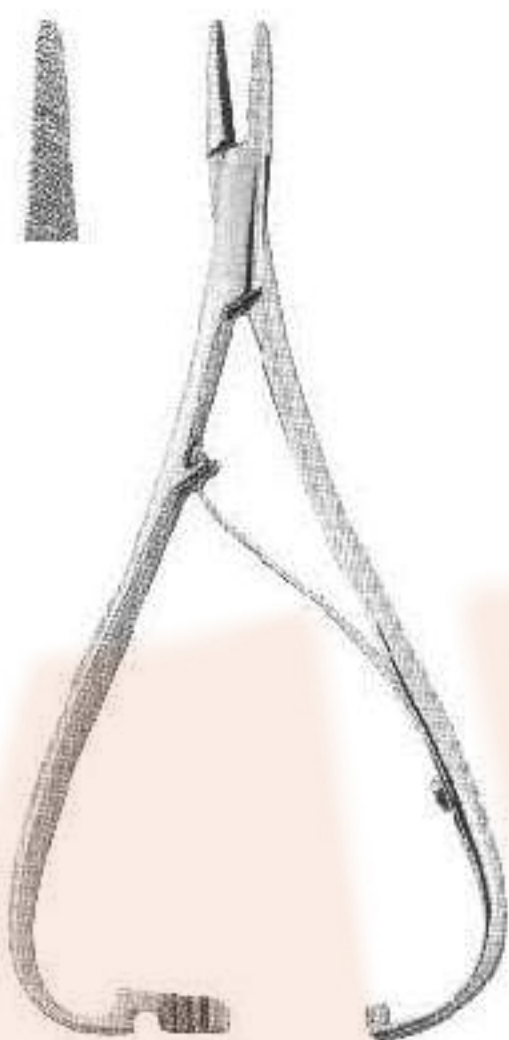

2236
Mathieu
14 cm

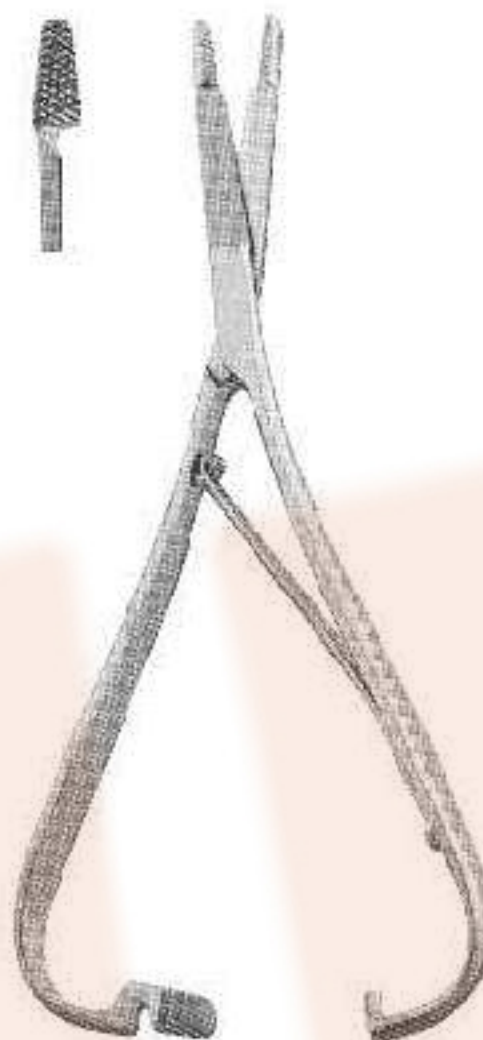

2237
Mathieu
14 cm

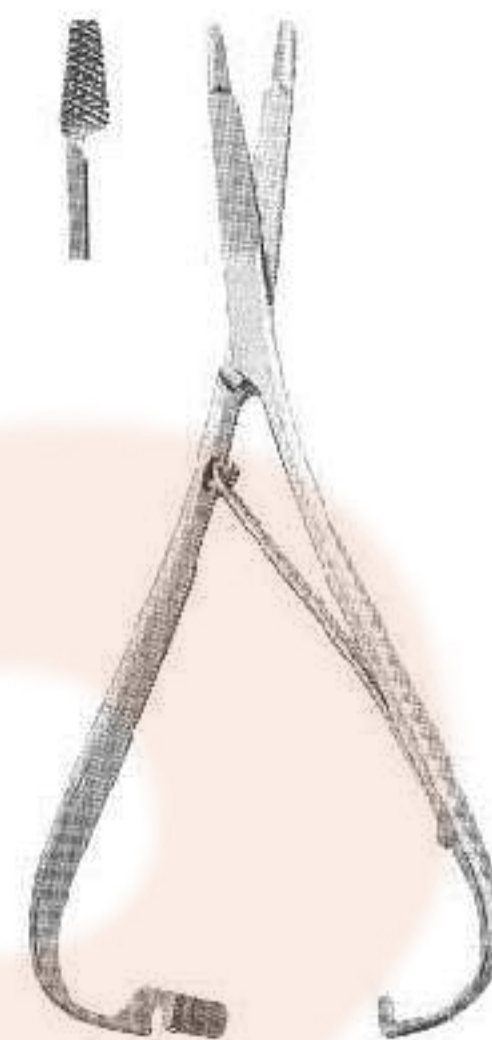

2238
Mathieu
14 cm

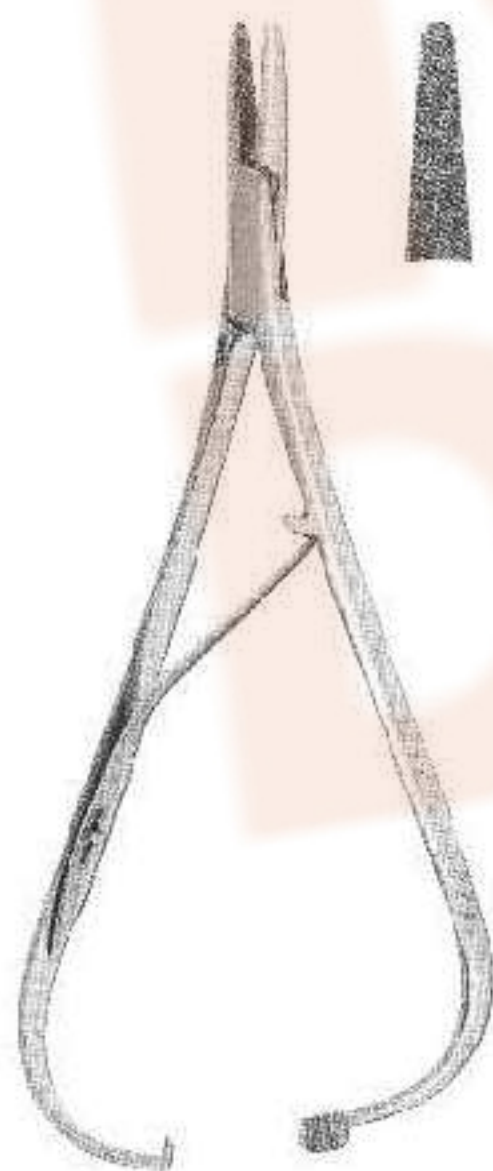

2239
Mathieu
17 cm



2240
Mathieu
17 cm

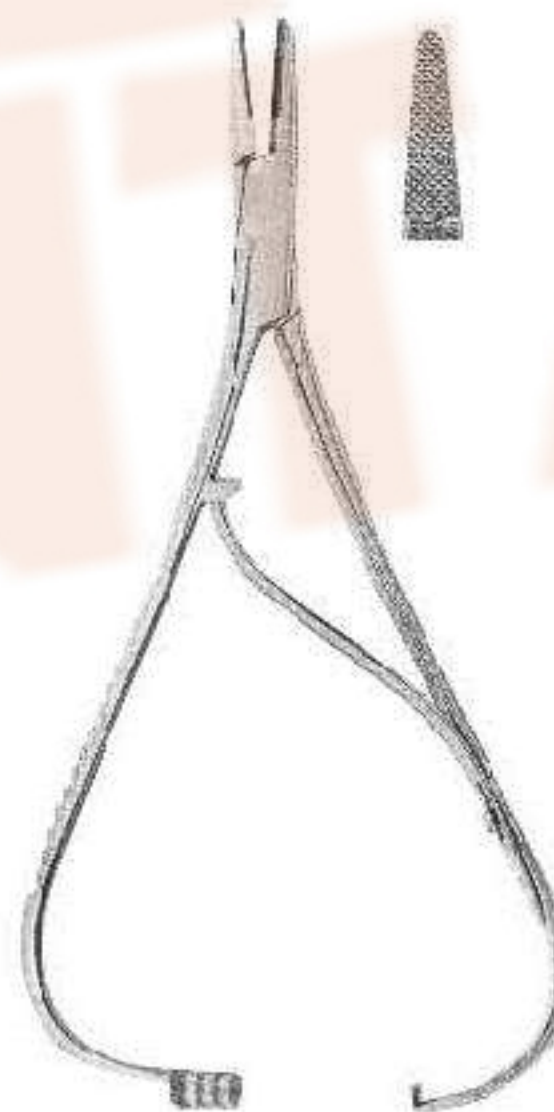

2241
Mathieu
14 cm



2242
Micro-Barraquer
18 cm



Needle Holders & Stainless Steel Saliva Ejectors

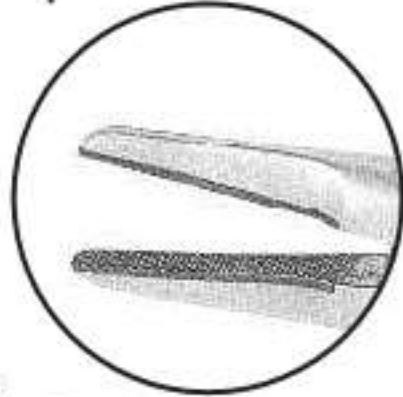

The tips have tungsten carbide inserts for better handling.



2243
Mathieu
17 cm

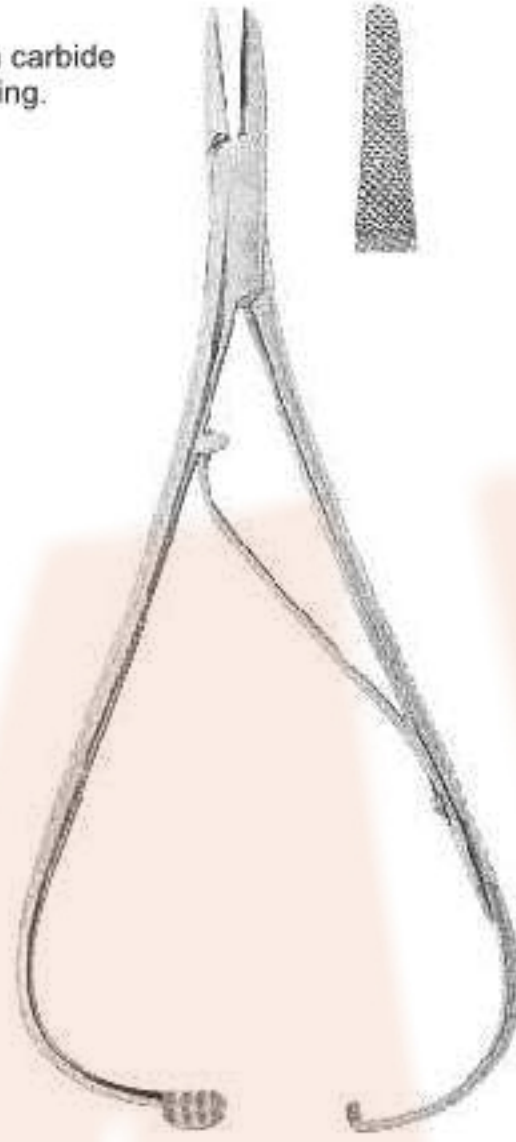

2244
Mathieu
17 cm



2245
Micro-Barraquer
14 cm

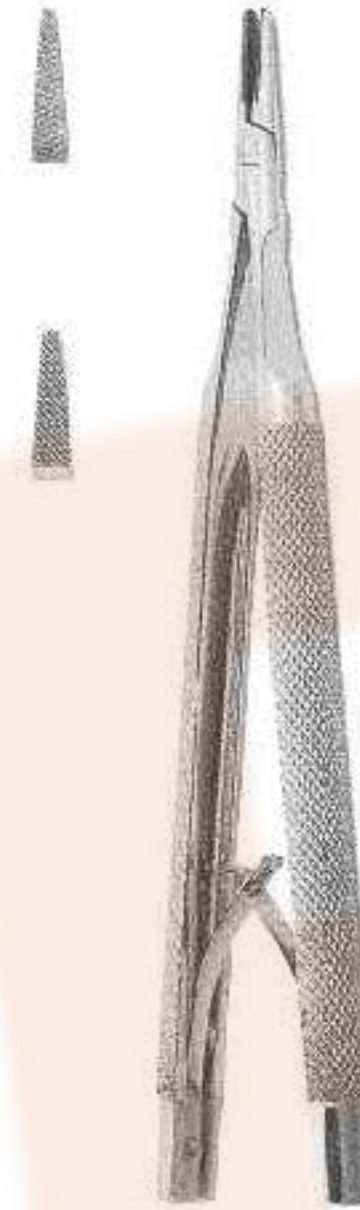

2246
Castroviejo
13 cm



2247
Castroviejo-Barraquer
13 cm



2248
Castroviejo
13 cm



2249
Castroviejo
13 cm



2251
18.03mm,cm



2252
18.04mm,cm



2253
18.05mm,cm



2250
Fig.6FR
Fraizer
15.02mm,cm



2254
Fig.12FR
Fraizer
15.04mm,cm



2255
Fig.10FR
Fraizer
15.03,3mm,cm



2256
Fig.8FR
Fraizer
15.02,7mm,cm



Water Syringes

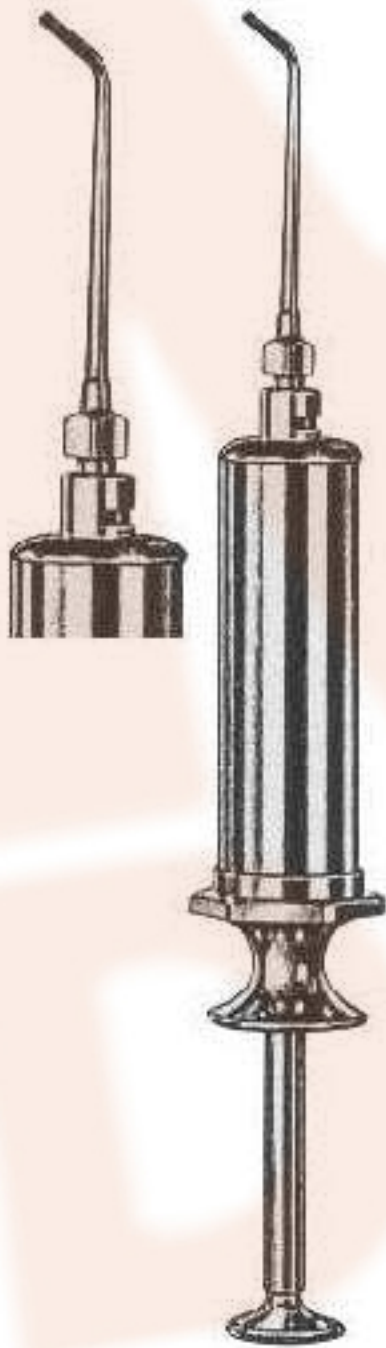

2300
Water Syringe complete with
1 cannula (Lure-Lock)



2301
Water Syringe complete with
1 cannula (Lure-Lock)



2302
Metal water syringe, self-filling,
with 1 cannula (Lure-Lock)



2303
Sparrel Barrel with
plunger suitable for
syringes



2304
Cannula, only, with
Luer-Lock connector
suitable for syringes



Syringes, Rulers, Band Adaptor, Position Gauge

MIR
DENTAL

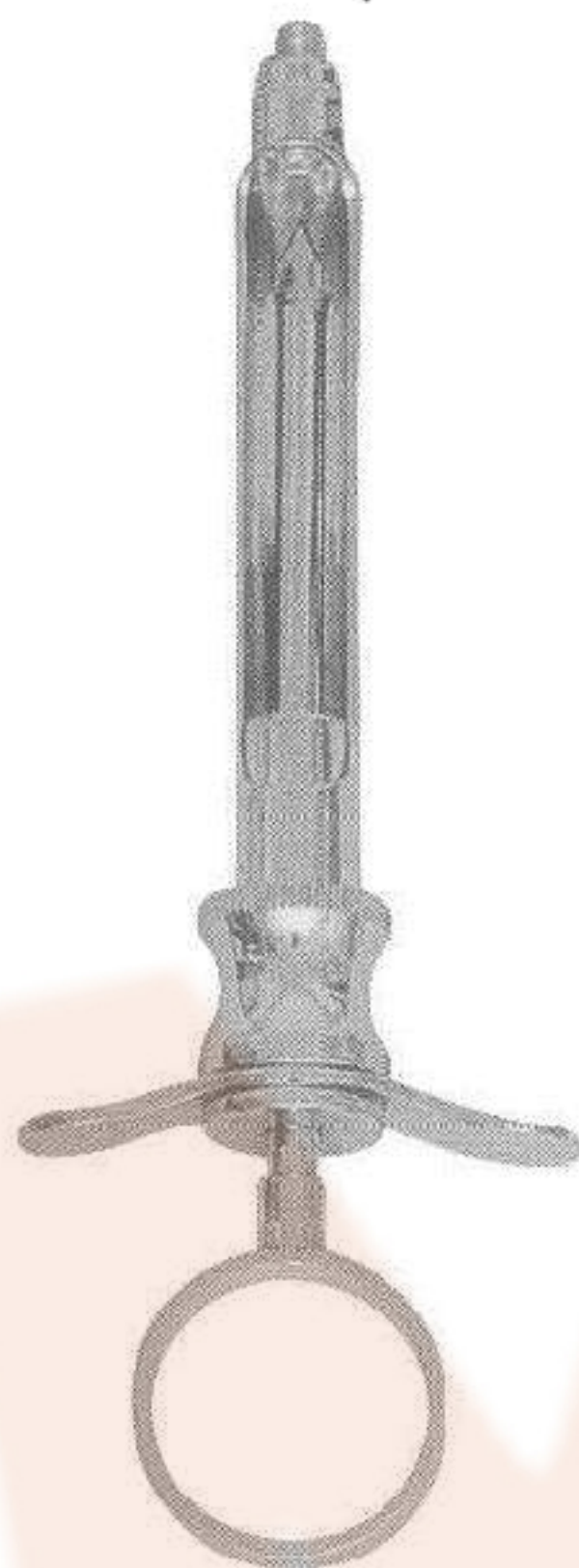

2305
Aspirating Syringe

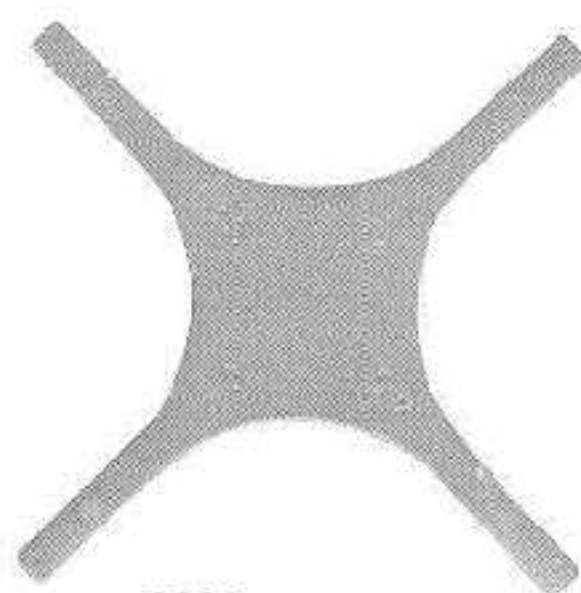

2306
Position Gauge

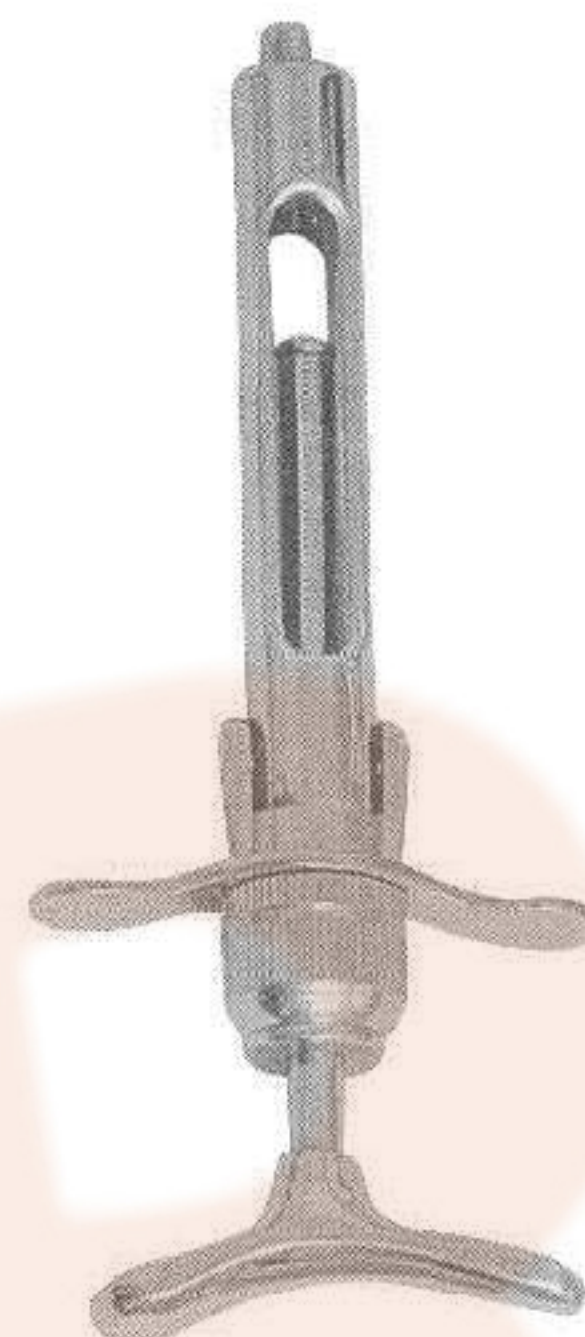

2307
Breech Loading Syringe

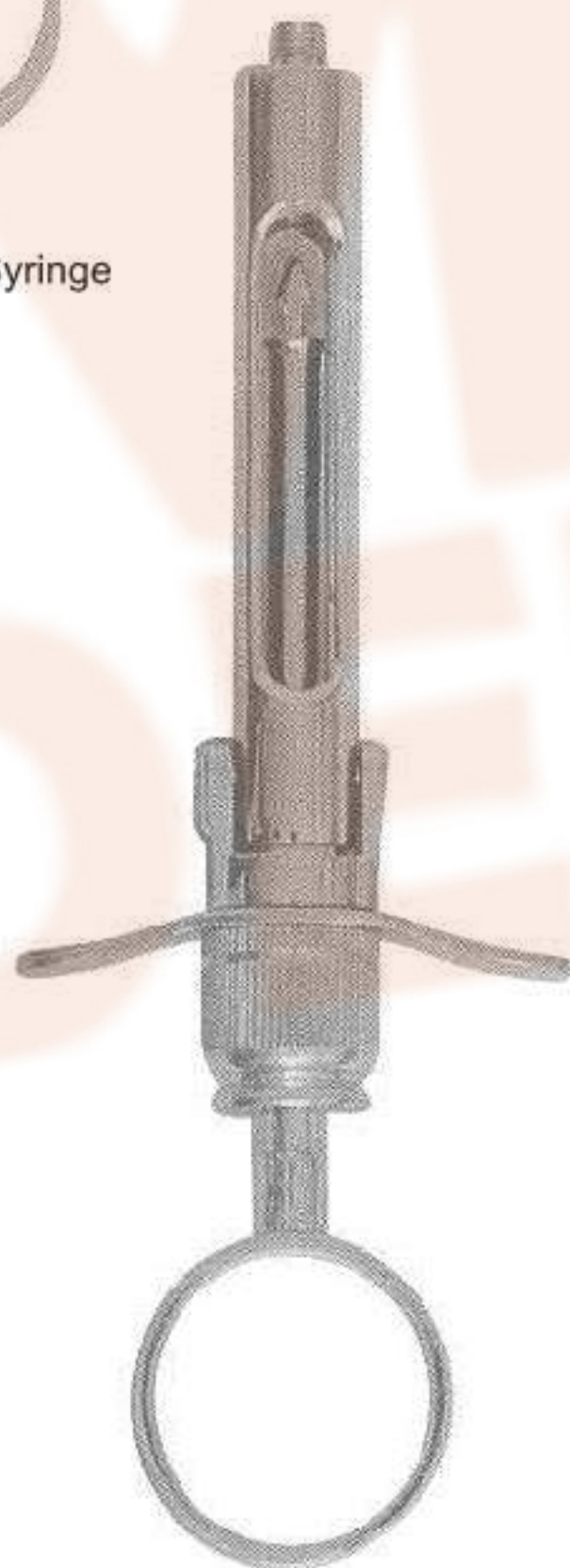

2308
Aspirating & Breech Syringe



2309
Band Adaptor

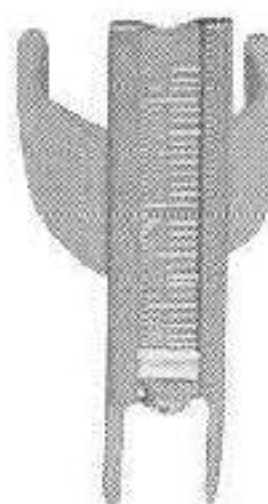

2310
Endo Finger Ruler
With Adjustable Slide

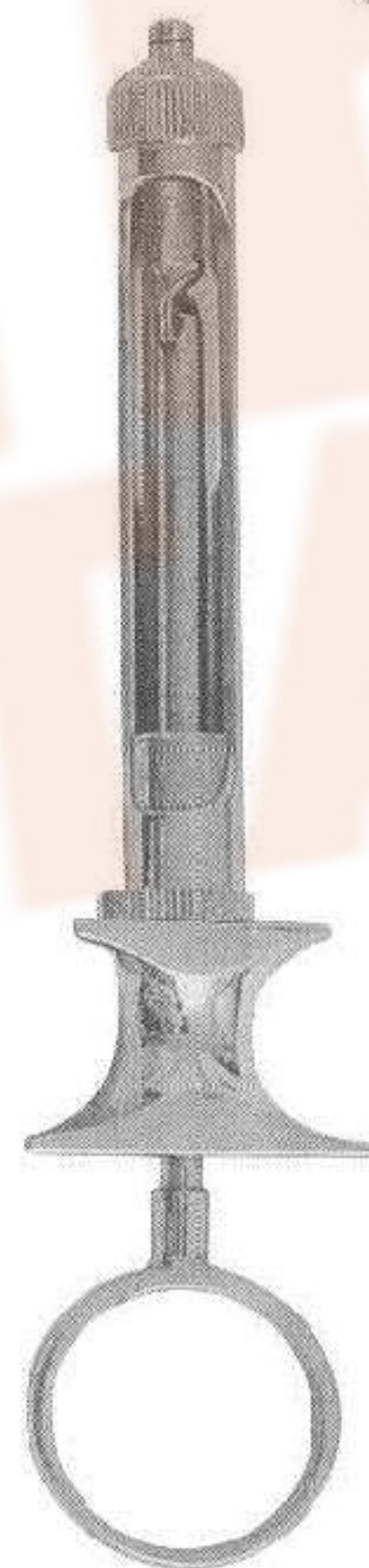

2311
Aspirating Syringe



Dental Syringes



2312



2313



2314

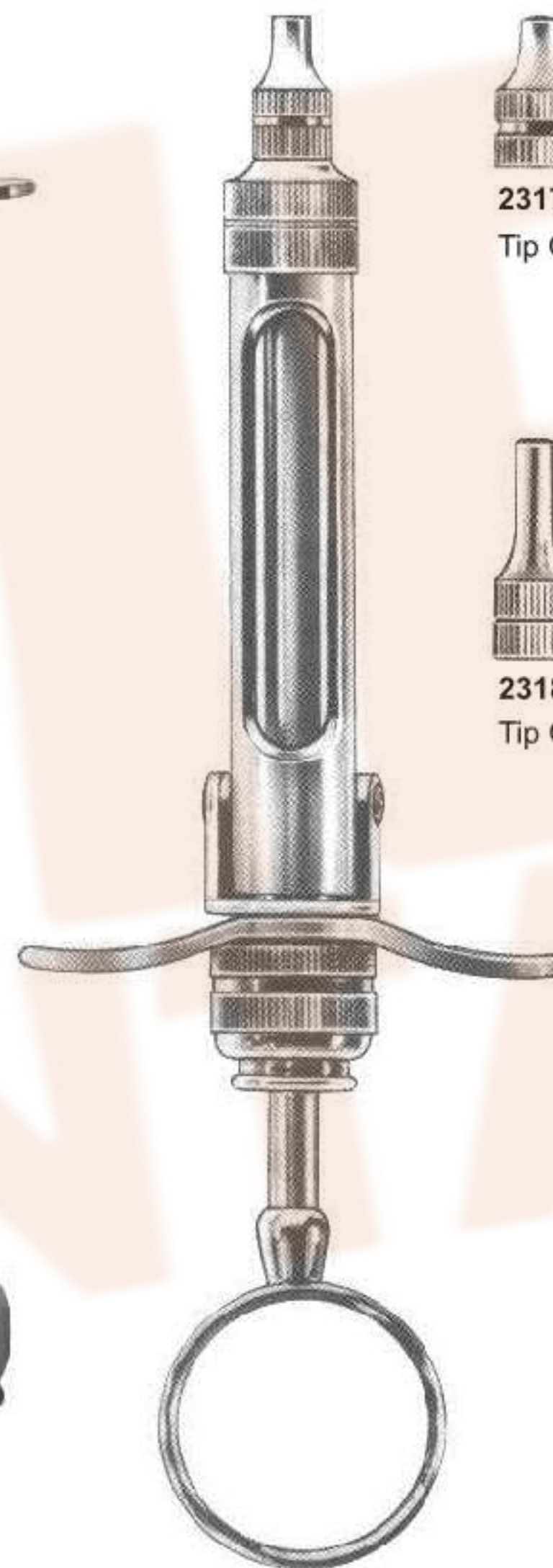

2315 1,8 ml
2316 2,2 ml

Cartridge Syringe complete
With 2 tips and without needles



2317
Tip Only, short



2318
Tip Only, long



2319



2320



2321



Intra-Ligamental Syringes & Dental Syringes



2322
Cork screw tip



2323
Cork screw tip

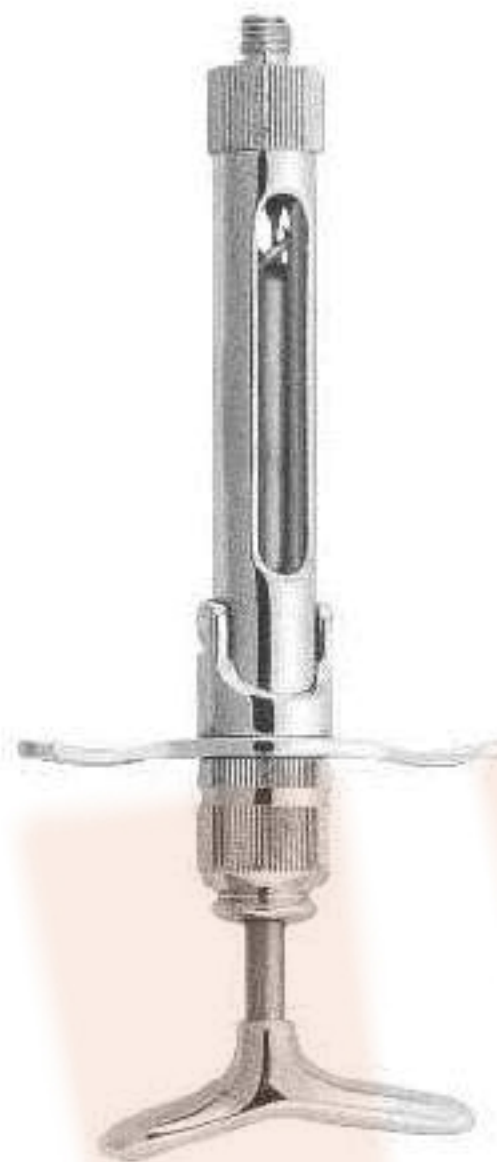

2324
Folding type, cork screw tip



2325
Folding type, cork screw tip



2326



2327
Cork screw tip



2328
Spare cap with metric thread



2329
With Whitworth thread



2330
Autoclavable Plastic Protection sleeve



2331
Brass syringe with stainless steel moving parts

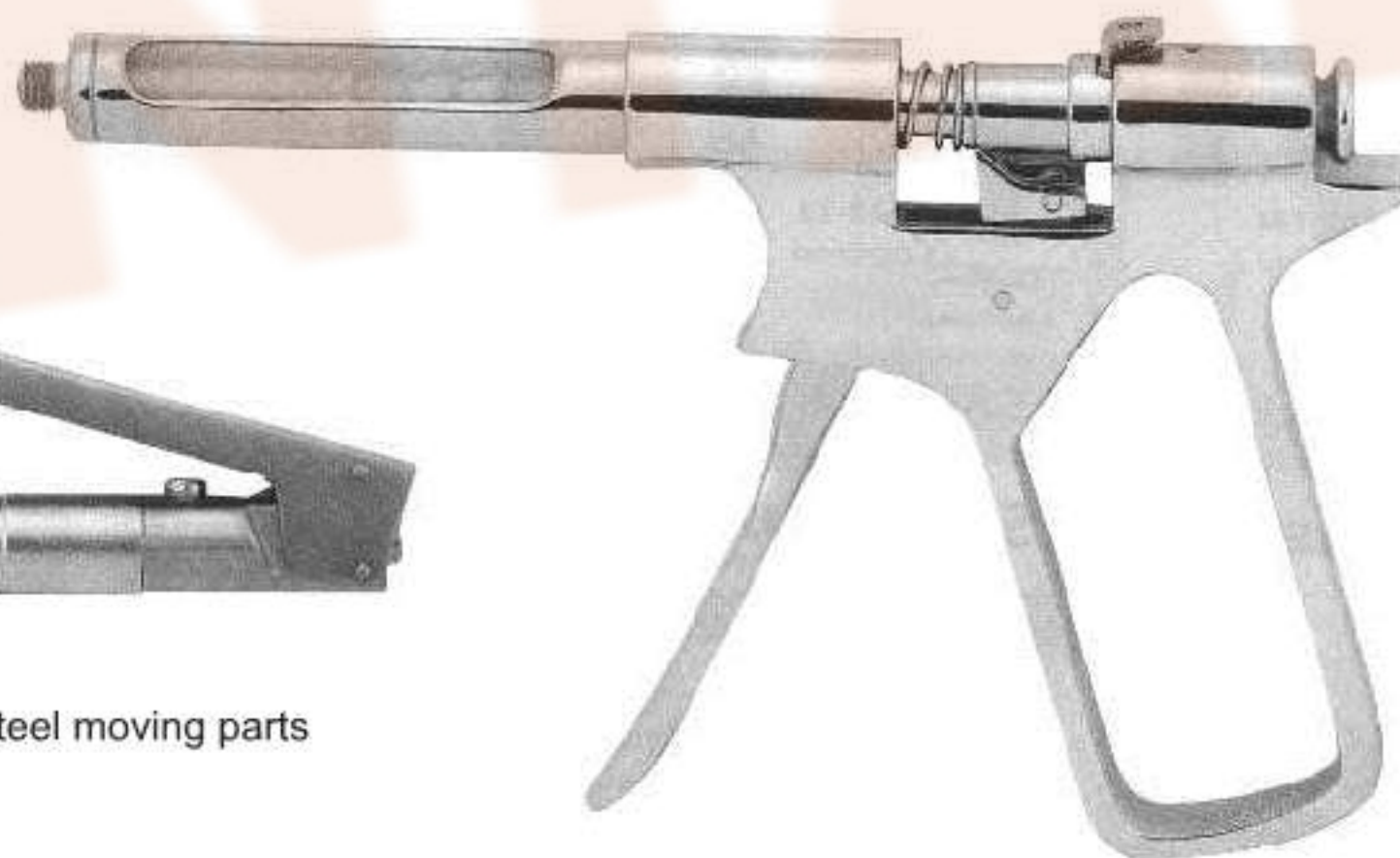

2332
Brass syringe with stainless steel moving parts



Dental Tweezers



2400
College
15 cm



smooth



2401
College
15 cm



serrated



2402
College
15 cm



smooth



2403
College
15 cm



serrated



2404
College
15 cm



smooth



2405
College
15 cm



serrated



2406
College
15 cm



smooth



2407
College
15 cm



serrated



Dental Tweezers



2408
Meriam
16 cm



smooth



2409
Meriam
16 cm



serrated



2410
Meriam
16 cm



smooth



2411
Meriam
16 cm



serrated



2412
Meriam
16 cm



smooth



2413
Meriam
16 cm



serrated



2414
Meriam
16 cm



smooth



2415
Meriam
16 cm

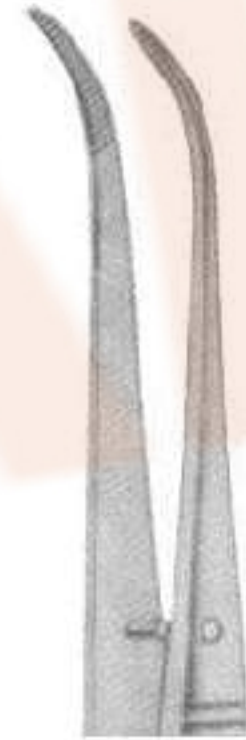

serrated



Dental Tweezers



2416
College
14.5 cm, 5 3/4"

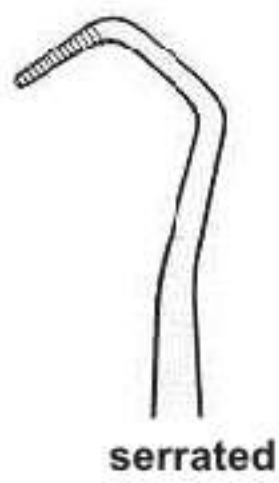

serrated

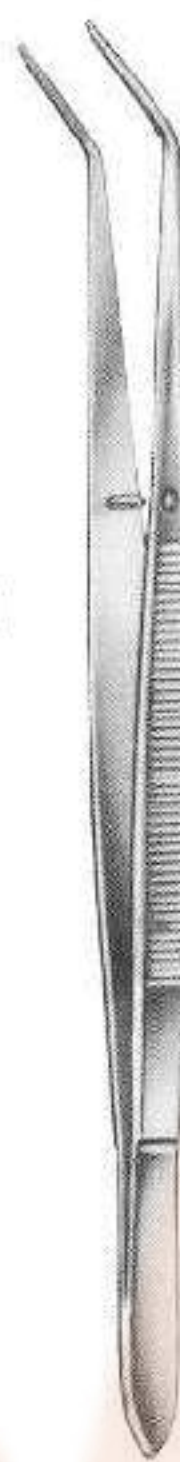

2417
Flagg
16 cm, 6 1/4"



serrated



2418
Flagg
16 cm, 6 1/4"



smooth



2419
Landgraf
15 cm, 6"

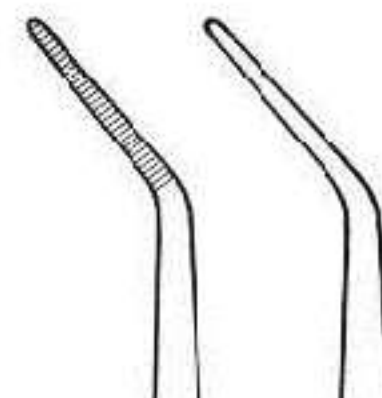

serrated smooth

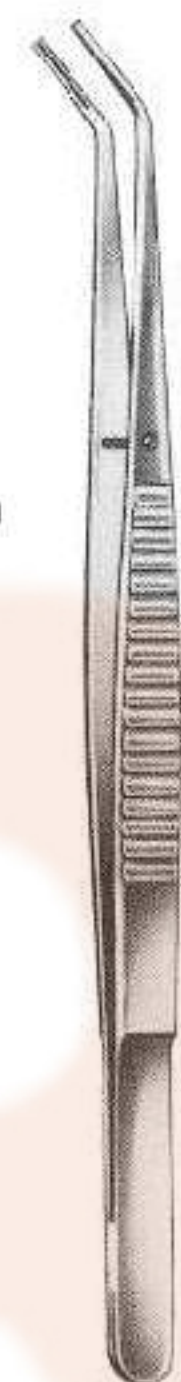

2420
15,5 cm, 6 1/8"



smooth

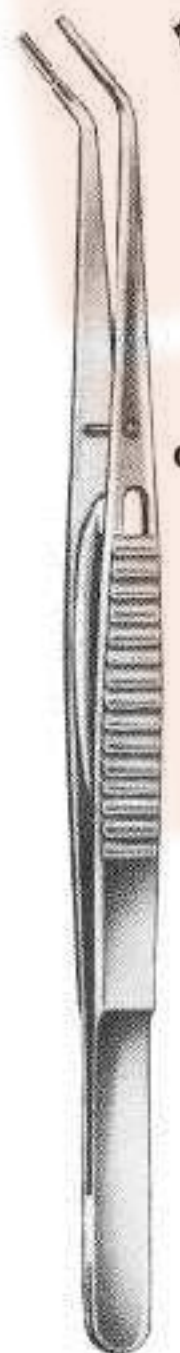

2421
15.5 cm, 6 1/8"



con cierre



2422
London-College
15 cm, 6"



serrated



2423
London-College
15 cm, 6"



smooth



2424
London-College
15 cm, 6"



serrated



2425
London-College
15 cm, 6"



smooth



Dental Tweezers

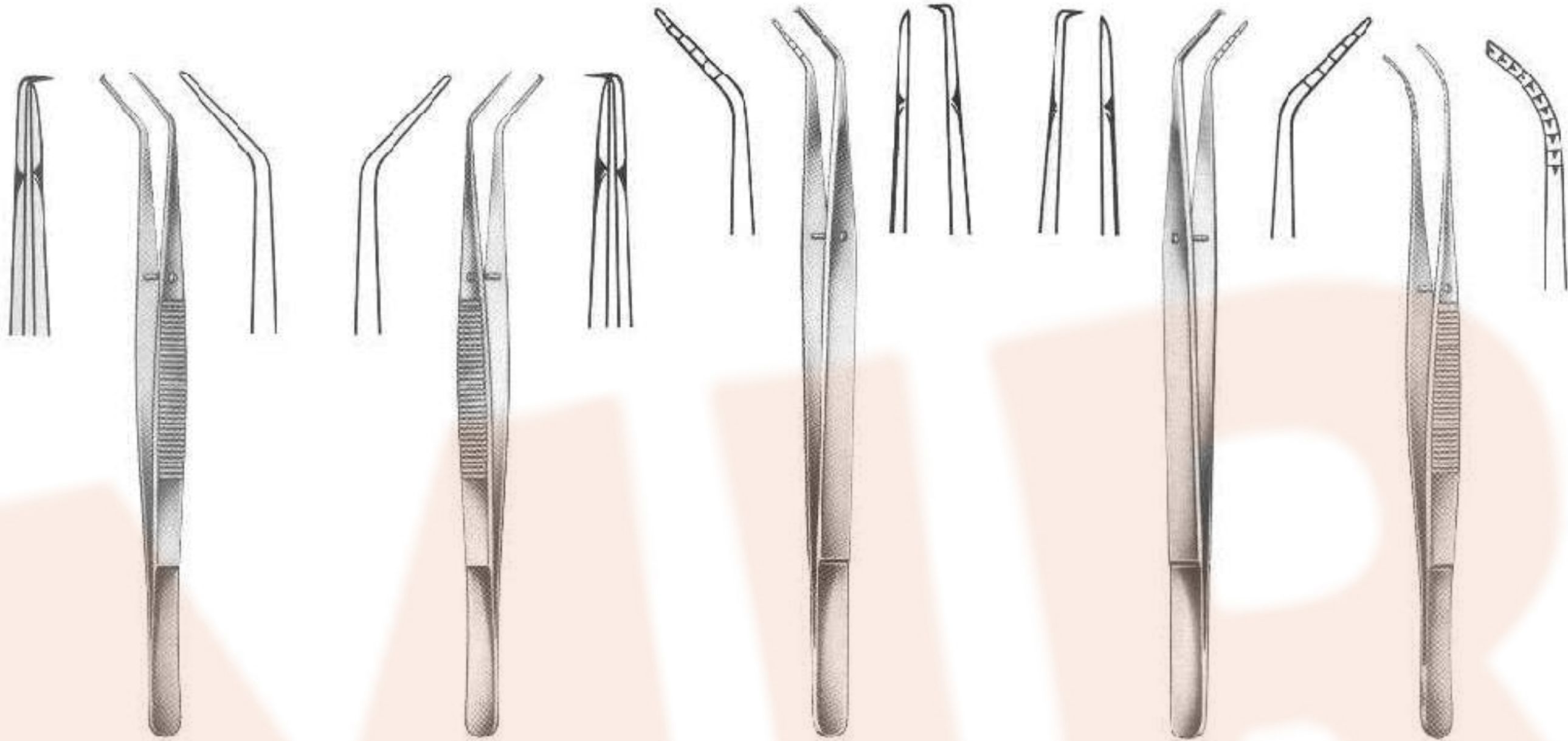

2426
CK1
15 cm, 6"

2427
CK2
15 cm, 6"

2428
GF2
16 cm, 6 1/4"

2429
Gf1
16 cm, 6 1/4"

2430
Kopp
15.5 cm, 6 1/8"



2431
Kopp
15.5 cm, 6 1/8"

2432
15 cm, 6"

2433
16.5 cm, 6 1/2"

2434
15.5 cm, 6 1/8"

2435
15.5 cm, 6 1/8"



Dental Tweezers



2436
London-College
15 cm, 6"

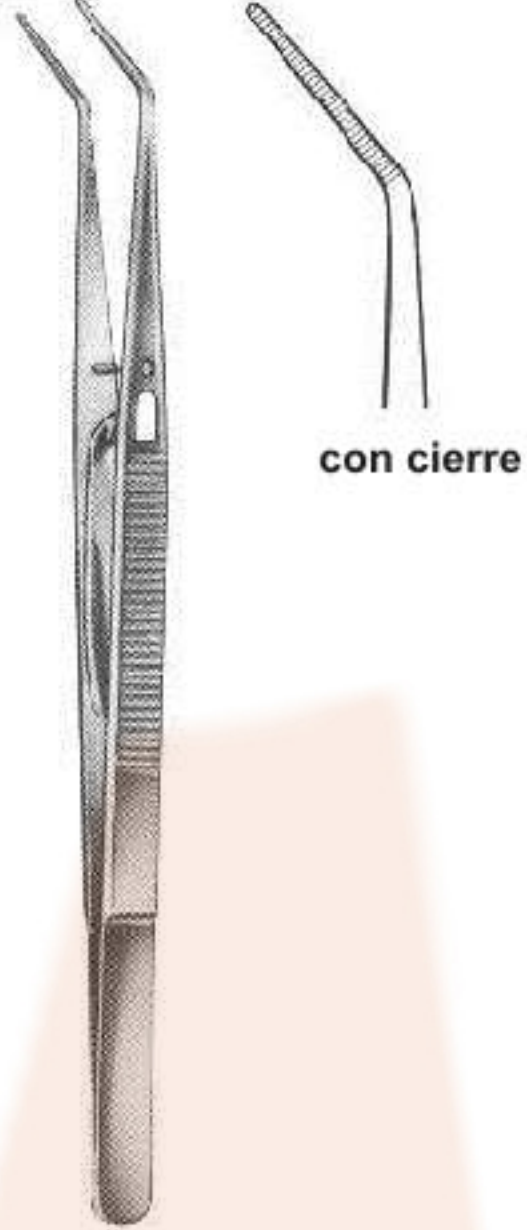

2437
London-College
15 cm, 6"

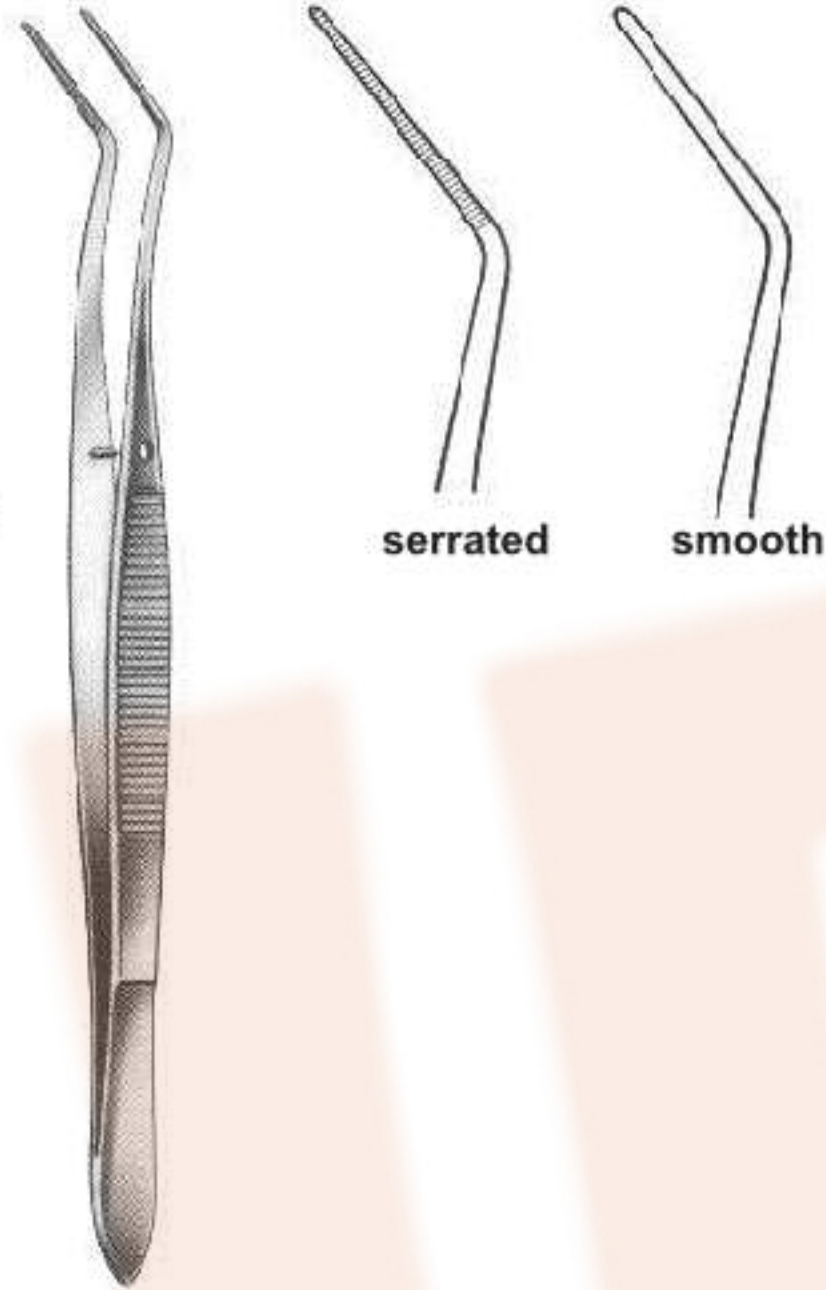

2438
Meriam
16 cm, 6 1/4"

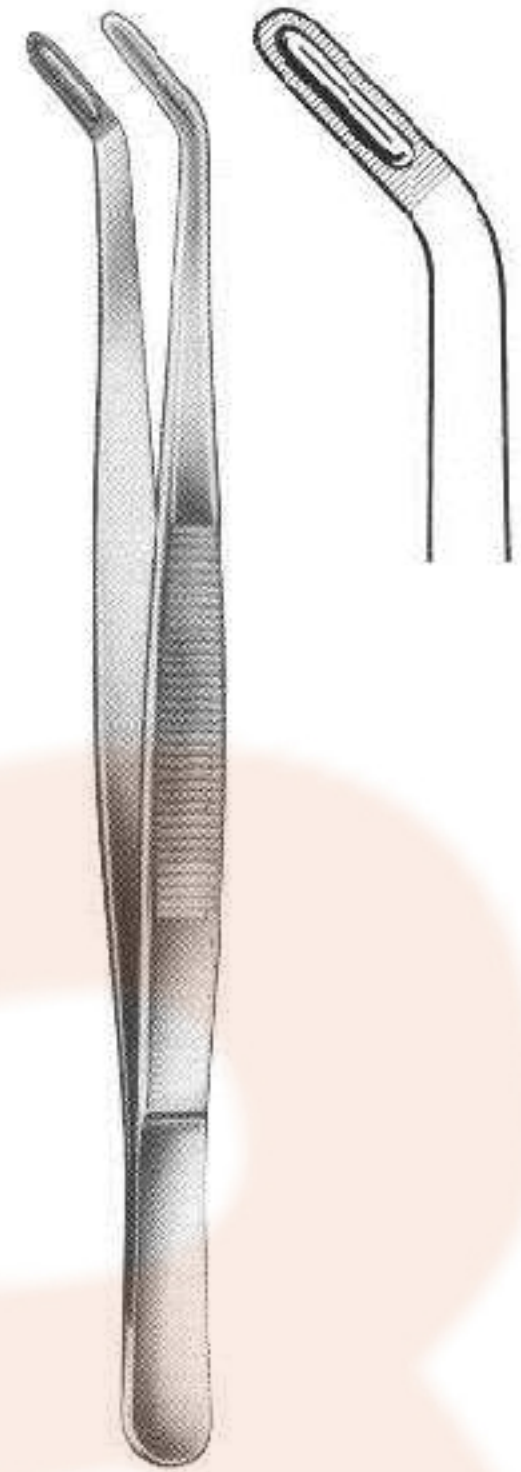

2439
Allen
18 cm, 7 1/8"



2440
Albrecht
16 cm, 6 1/4"



2441
Albrecht
16 cm, 6 1/4"

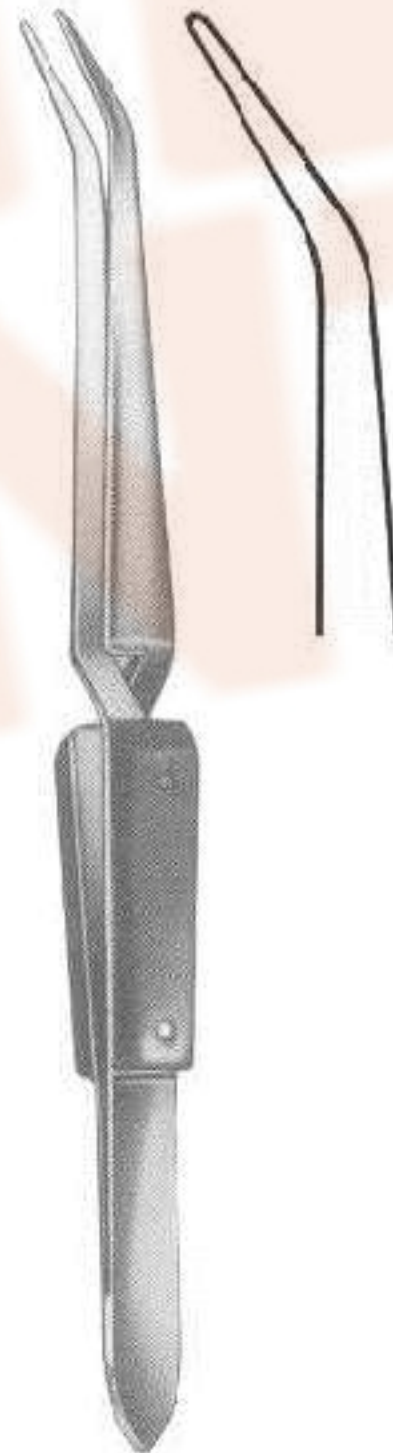

2442
16 cm, 6 1/4"

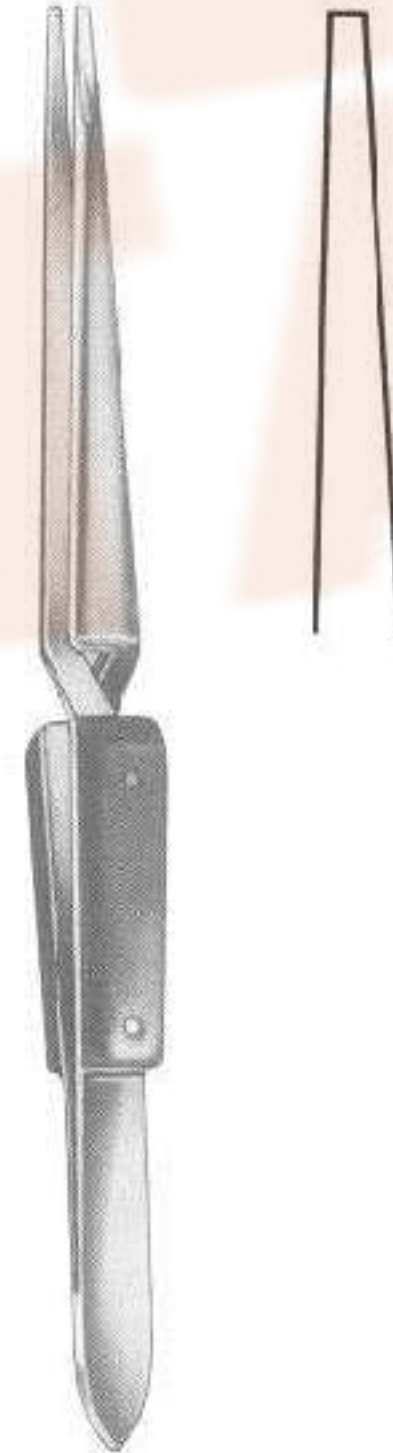

2443
16 cm, 6 1/4"



2444
16 cm, 6 1/4"



Rubber Dam Clamp Forceps

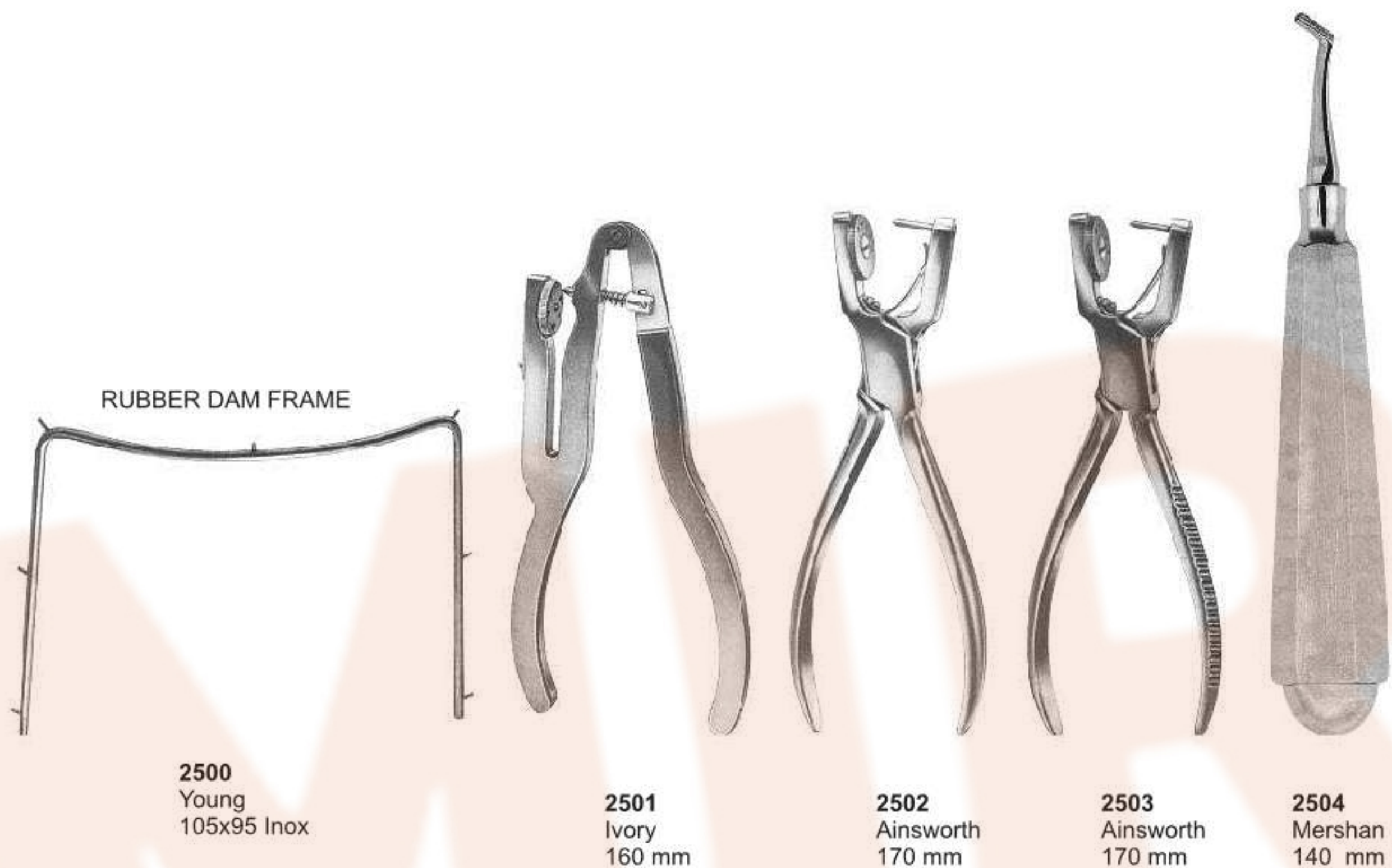

CLAMPS (PLIERS)

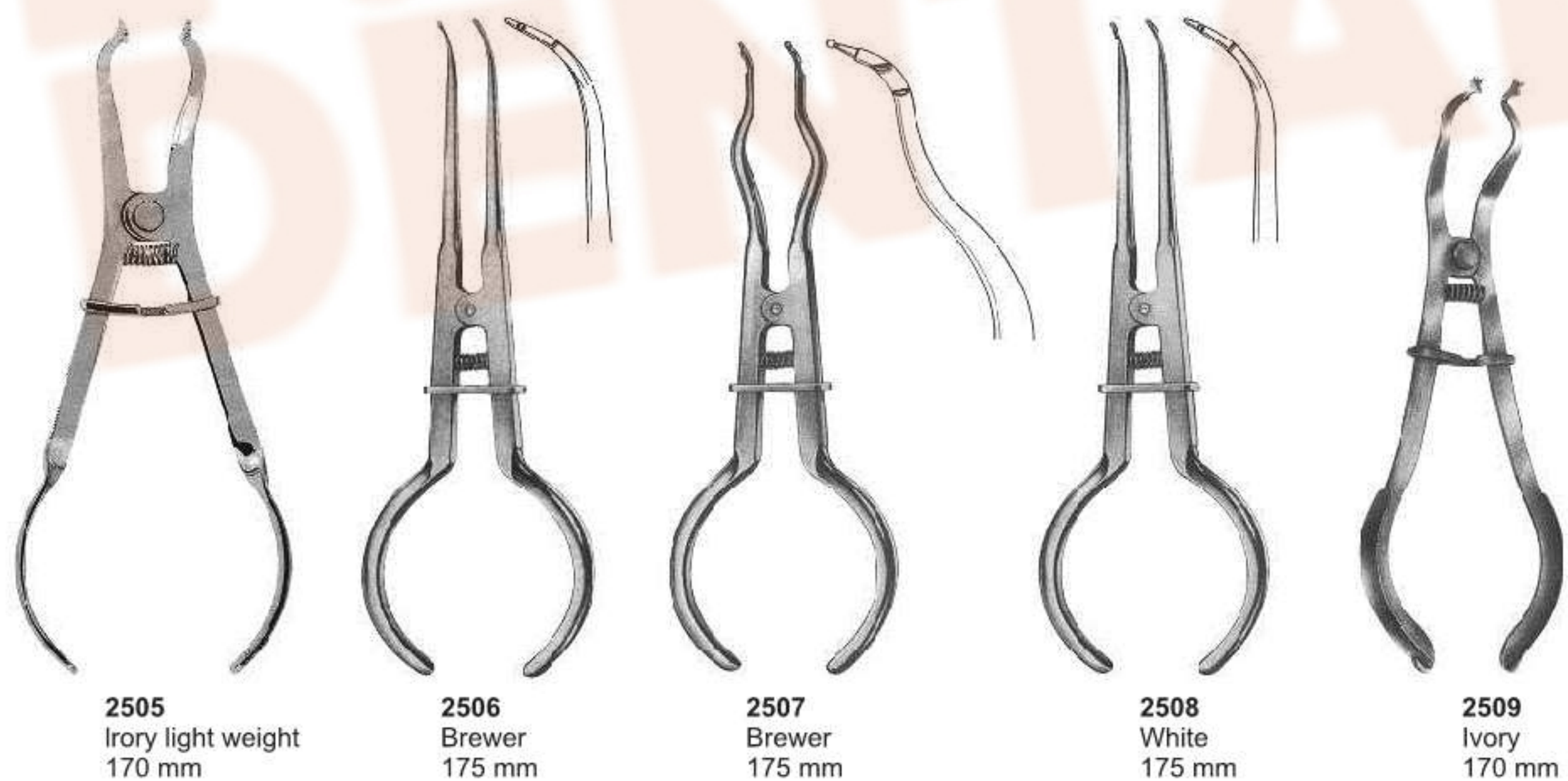



Rubber Dam Clamps

Anterior

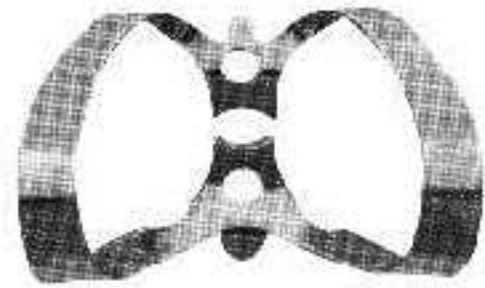

2510 - 9
Winged
Labial Clamp



2511 - 9T
Winged
Edged Labial Clamp



2512 - 212
Winged
Cervical Clamp

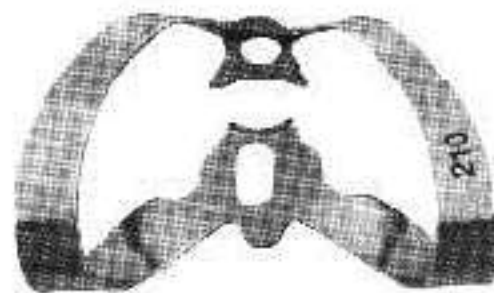

2513 - 210
Winged
Labial Clamp

Premolars



2514 - 00
Winged



2515 - 0
Winged



2516 - W0
Wingless

For Small Teeth, Elongated or With Narrow Collars



2517 - 1
Winged



2518 - 1T
Winged



2519 - W1
Wingless

For General Use With Adjustable Jaws According To Gingival Line Shapes



2520 - 2A
Winged



2521 - 2AT
Edged, Winged



2522 - W2A
Wingless

For Premolars, With Elongated Collar



2523 - 2
Winged



2524 - 2T
Edged, Winged



2525 - W2
Wingless

For Premolars, With Elongated Collar



2526 - 29
Wingless



2527 - 60
Wingless



Rubber Dam Clamps

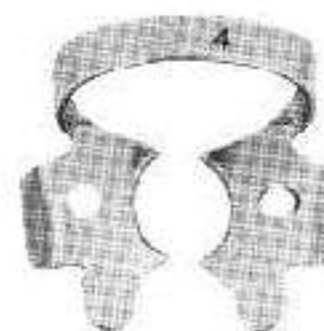
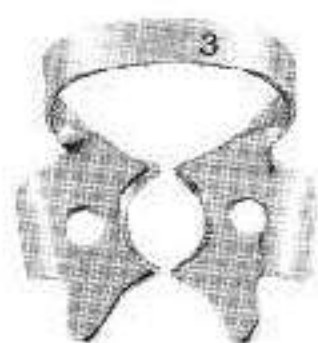

2528 - 3
Winged

2529 - W3
Wingless

2530 - 4
Winged

2531 - W4
Wingless

For Small Lower Molars

For Small Lower Molars With Round clamps



2532 - 7
Winged

2533 - W7
Wingless

2534 - 8
Winged

2535 - W8
Wingless

For Square Lower Molars

For Round Upper Molars

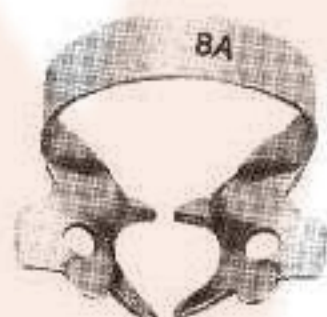

2536 - 8A
Winged

2537 - W8A
Wingless

2538 - 12A
Winged

2539 - 13A
Wingless

For Molar Roots

For Partially Broken Molars



2540 - 14
Winged

2541 - 14T
Edged Winged

2542 - W14
Wingless

2543 - 14A
Winged

2544 - W14A
Wingless

For Round Molars, Partially Broken, Undersized or Inclined

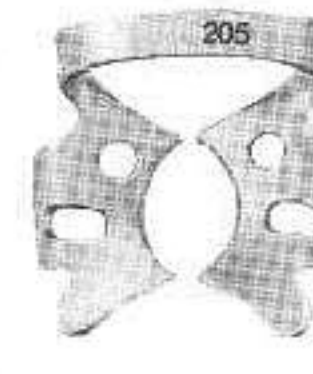

2545 - 26
Wingless

2246 - 51
Wingless

2547 - 202
Winged

2548 - 205
Winged



Matrix Retainers and Matrix Bands



2600
Ivory
63mm

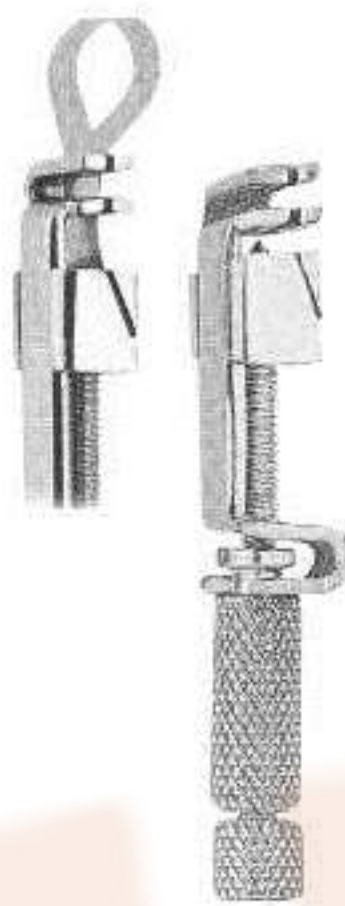

2601-1
Tofflemire-Universal



2602-2
Tofflemire-Junior



2603-3
Tofflemire-Senior

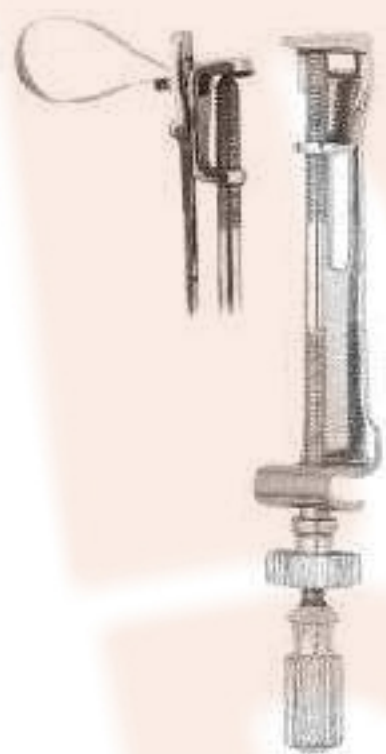

2604-5
Ivory 8
5 mm

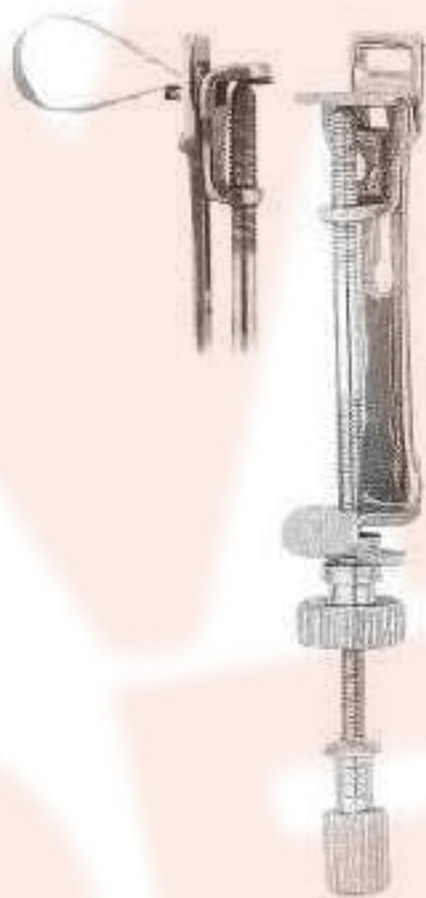

2605-6
Ivory 8
6 mm

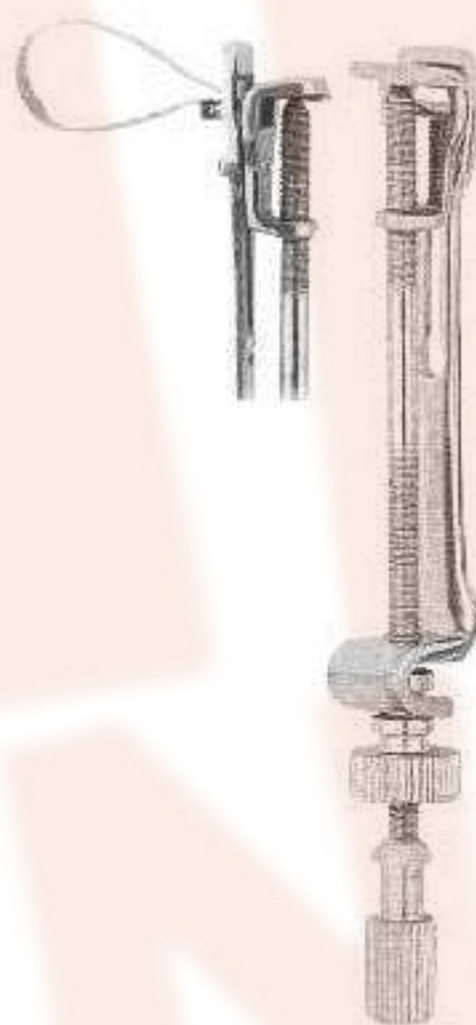

2606
Ivory 8
7 mm

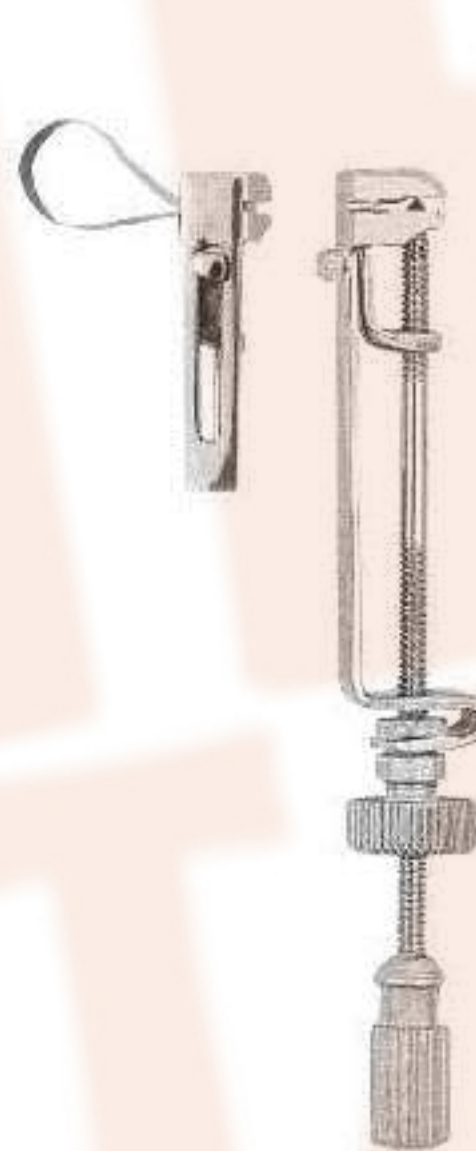

2607
Ivory 8 N

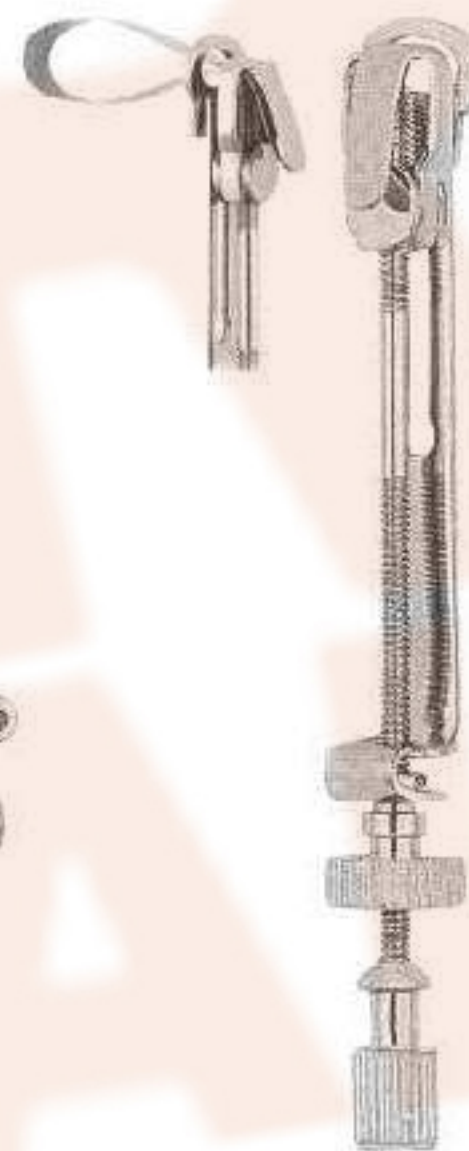

2608
Didner 8 P



2610-7

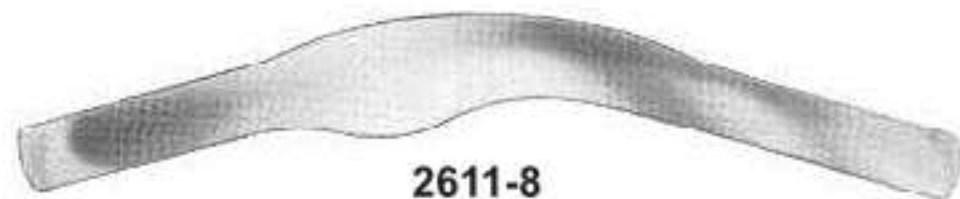

2611-8



2612-9

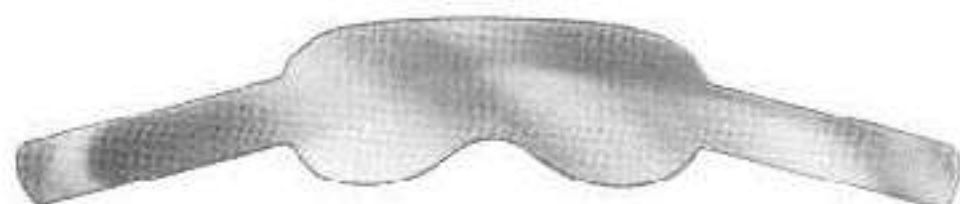

2613-10

1750-5 mm x 100 cm
1750-6 mm x 100 cm
1750-7 mm x 100 cm



2609

For Molars and Premolars



2614-11

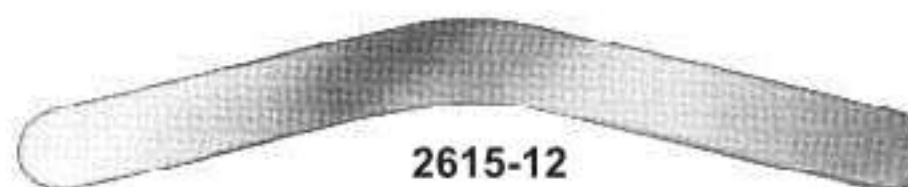

2615-12

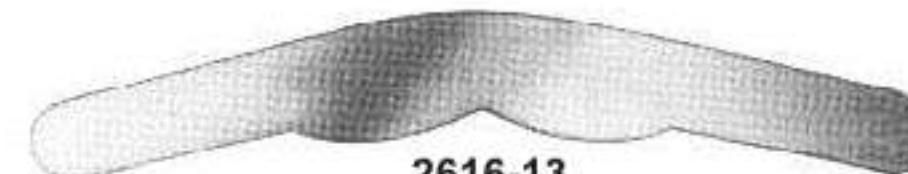

2616-13



Matrix Bands



2617
Molar
Fig 7

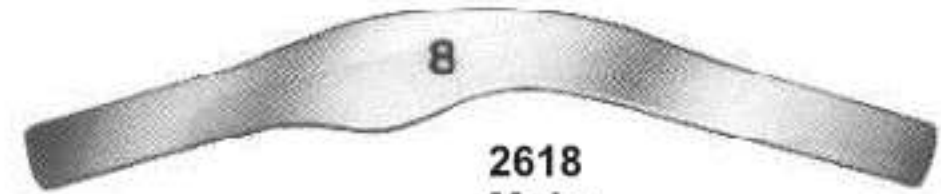

2618
Molar
Fig 8

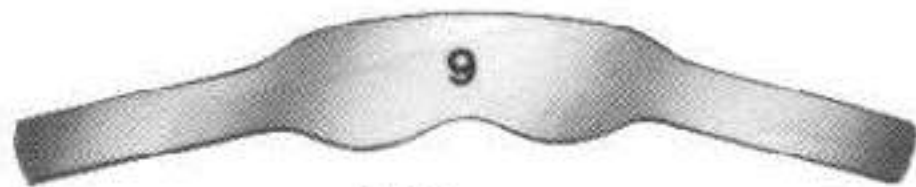

2619
Molar
Fig 9



2620
Molar
Fig 10



2621
Tofflemire



2622
Tofflemire



2623
Tofflemire



2624
Bicuspid



2625
Bicuspid



2626
Bicuspid



2627
Bicuspid



2628
Bicuspid



2629
Bicuspid



2633



2630
Molar



2631
Molar

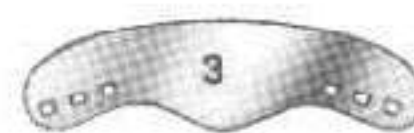

2632
Molars



Dental Crown Removers

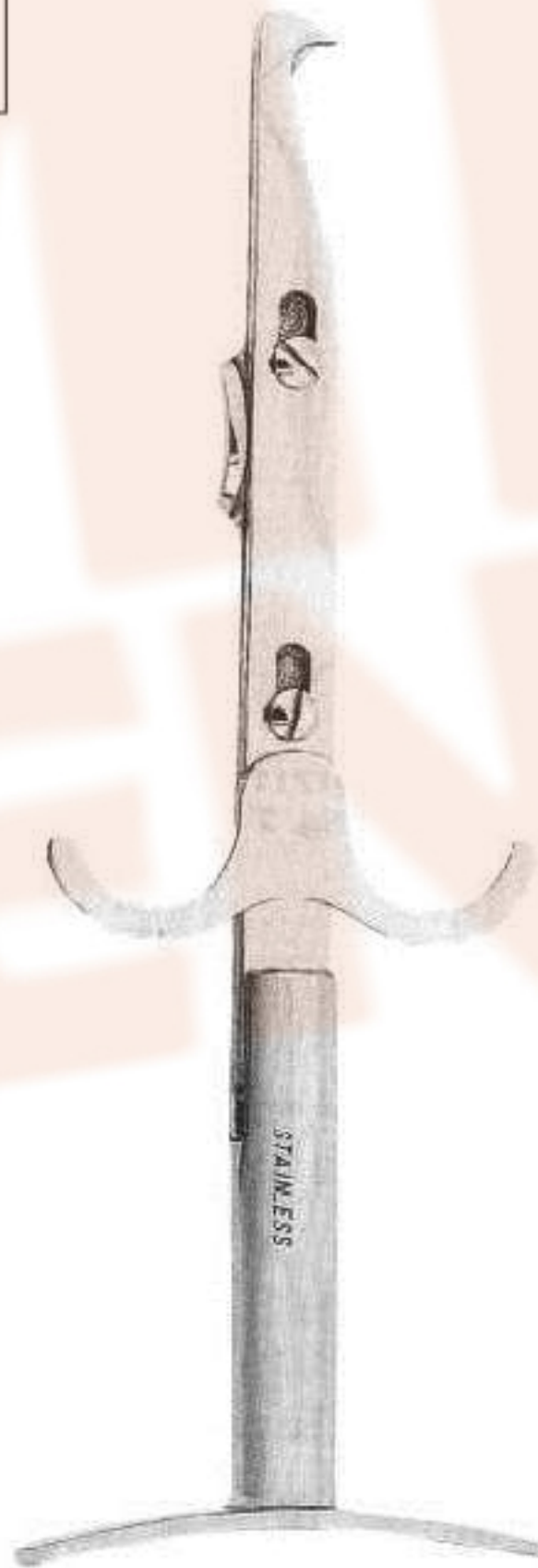
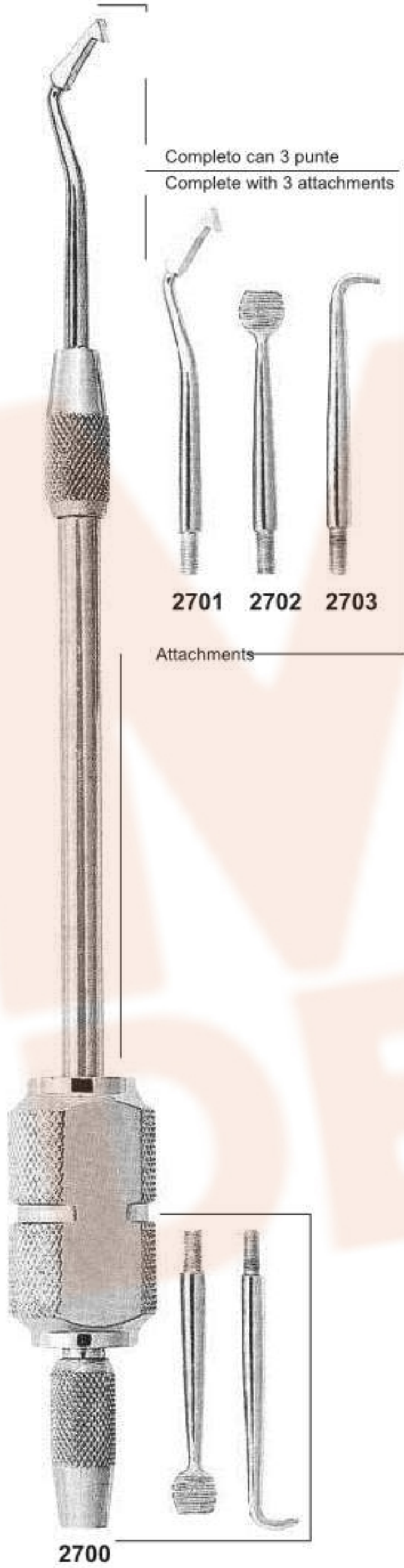

2704
Crown Spreader, Crown Remove.
Special instrument for crown spreading
after separating, simple and safe
operation.

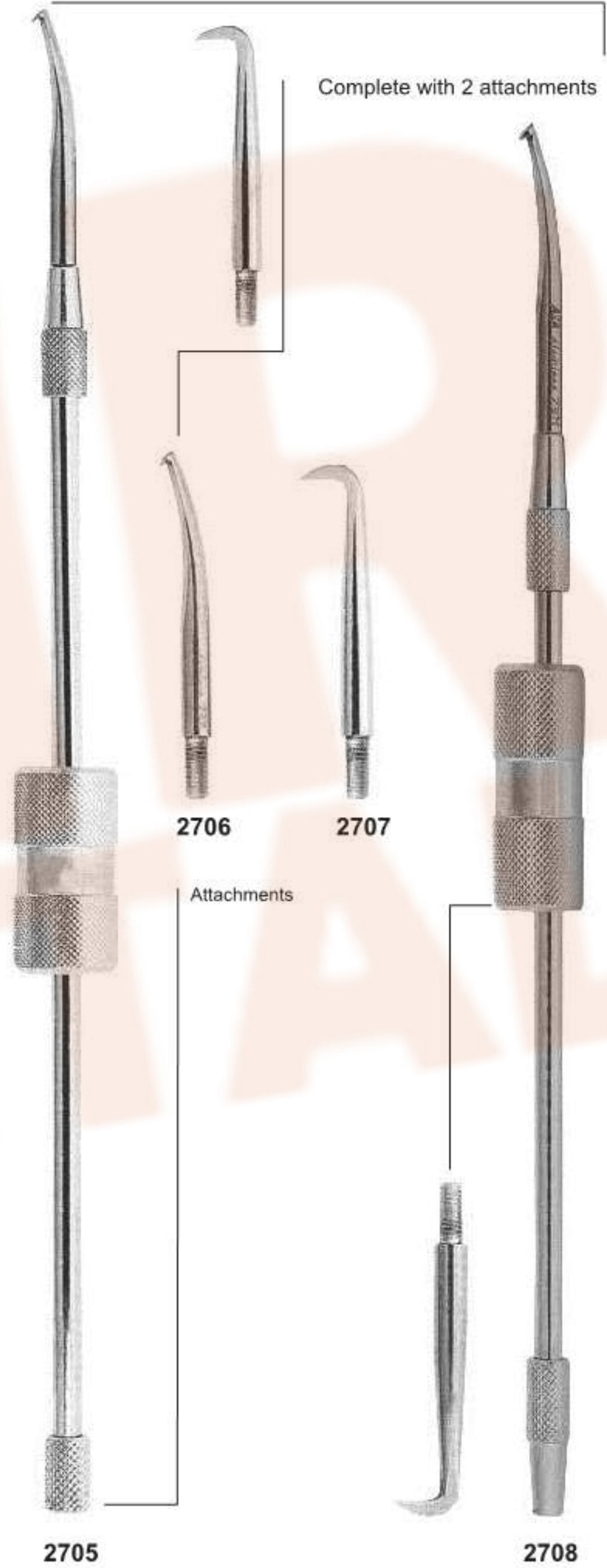



Dental Crown Removers, Scissors, Forceps, Amalgum Guns & Carriers



Universal "HM"
12 cm, 4 3/4"

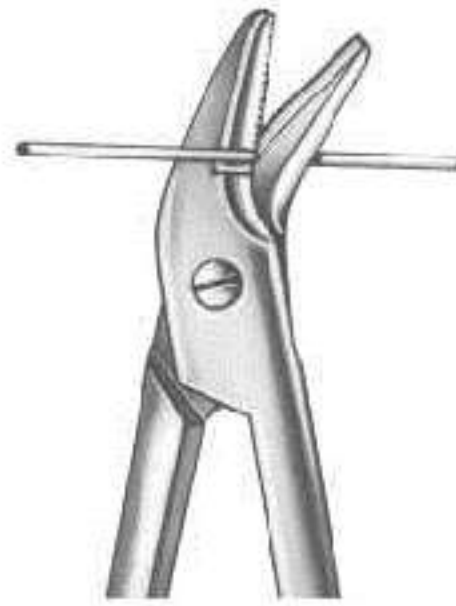

2709

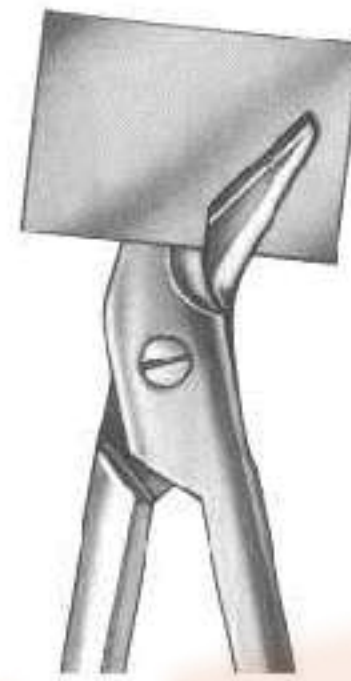

2710

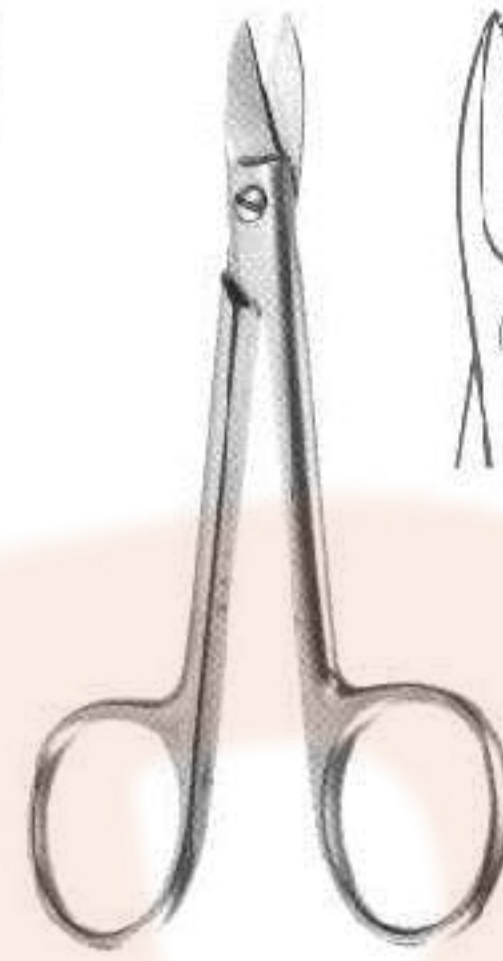

2711
Beebee
10,5 cm, 4 1/8"



2712
Mershon



2713
Morell



2714
Morell



2715
Morell



2716
Morell



2717
Treymann



2718
Automatic Crown Remover
With 2 Points



2719



2720



Amalgam Guns and Carriers

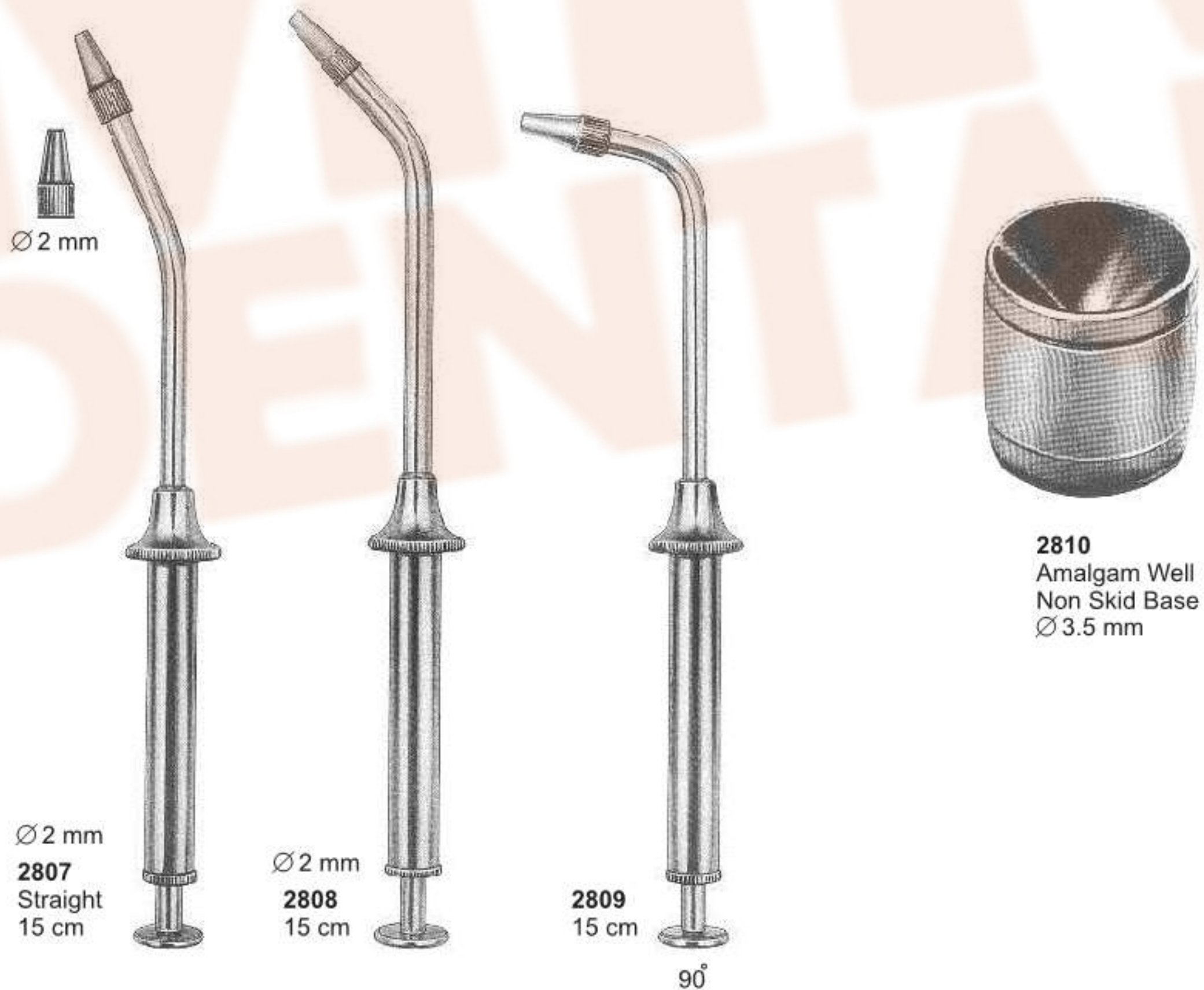
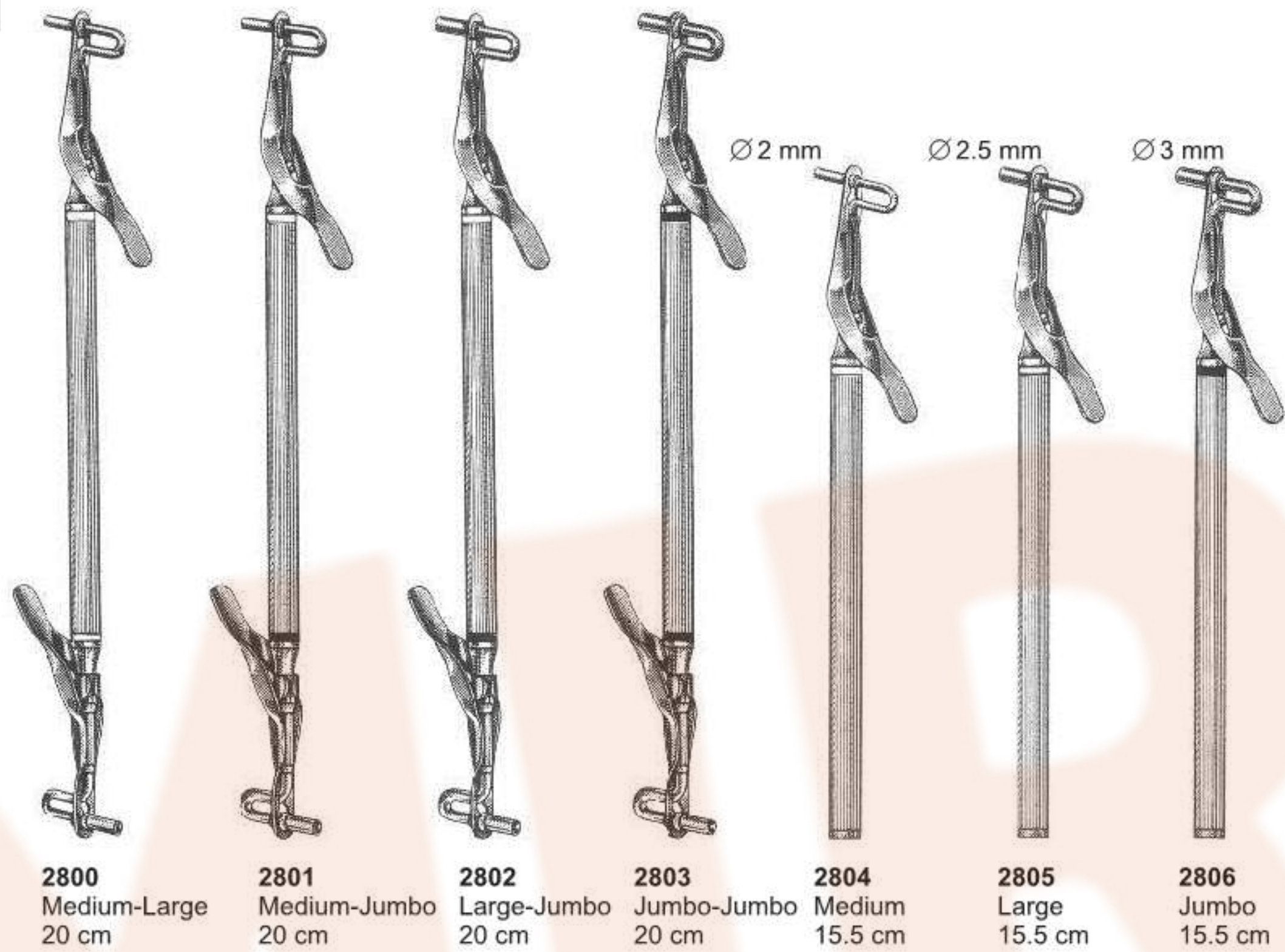



Copper ring removing pliers



2900
Bohm
11,5 cm



2901
Bohm
14,5 cm



2902
Furrer
16 cm

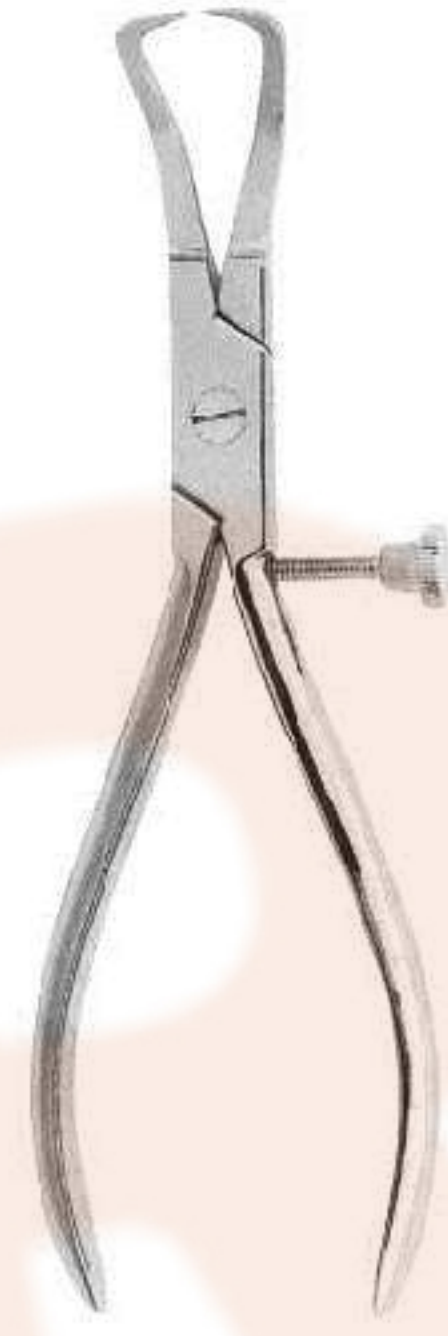

2903
Furrer
16 cm



2904
Miller
15 cm



2905
Miller
15 cm



2906
Kelly
14 cm



2907
Halstead-Mosquito
12 cm



2908
Micro-Mosquito
10 cm



Rongeurs

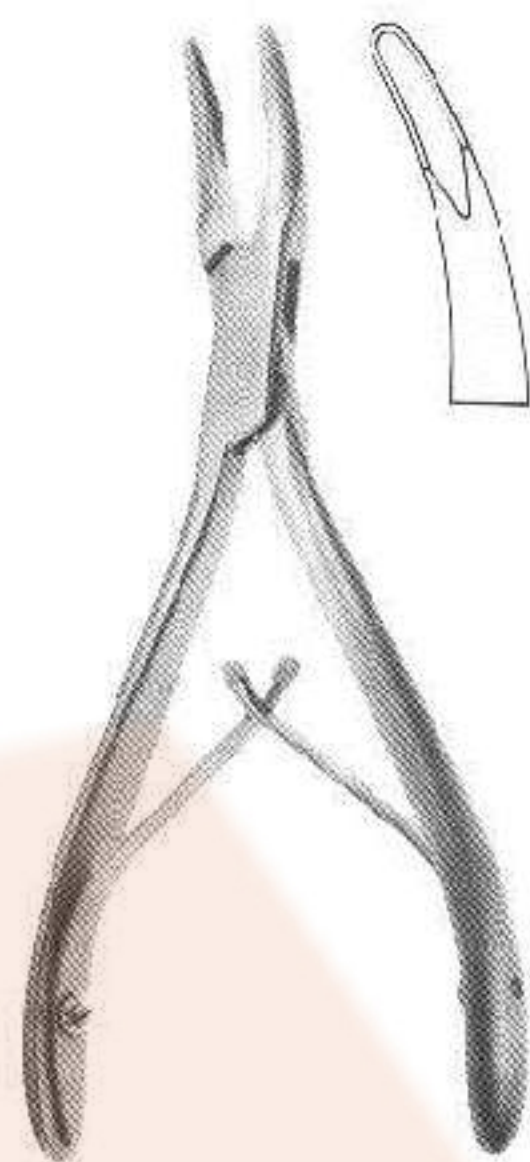

3000
Friedmann
14 cm, 5 1/2"

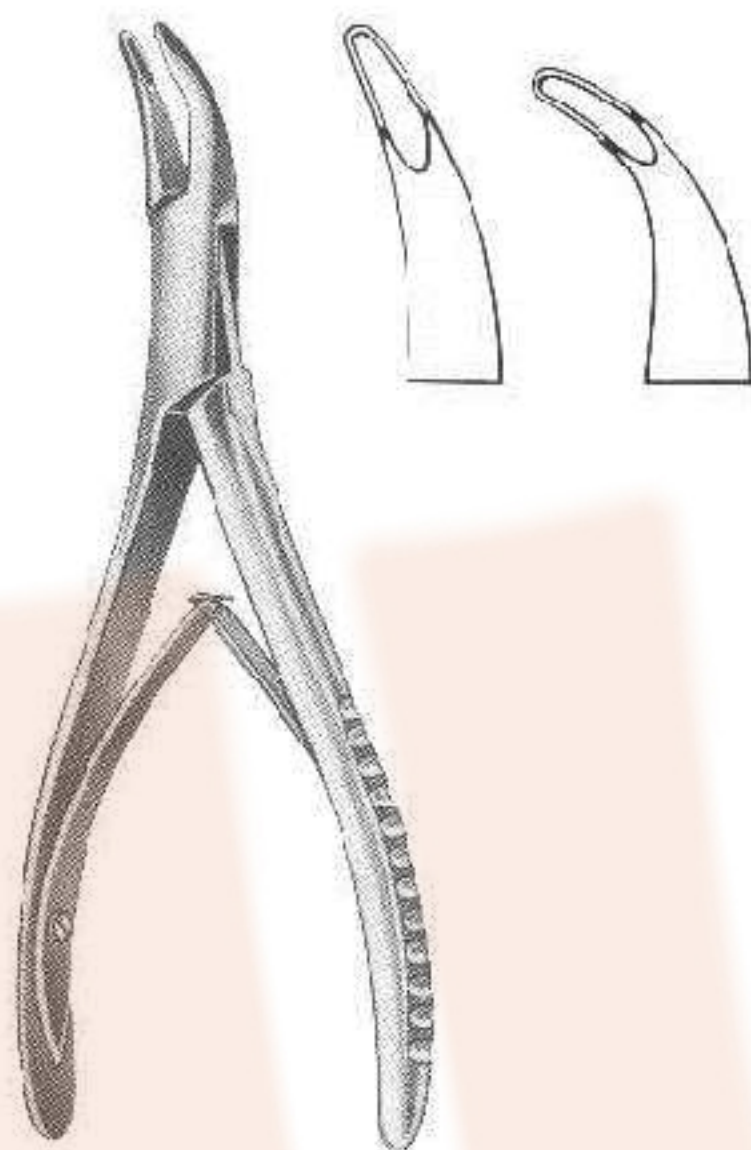

3001
14 cm, 5 1/2"



3002
Mead
14 cm, 5 1/2"

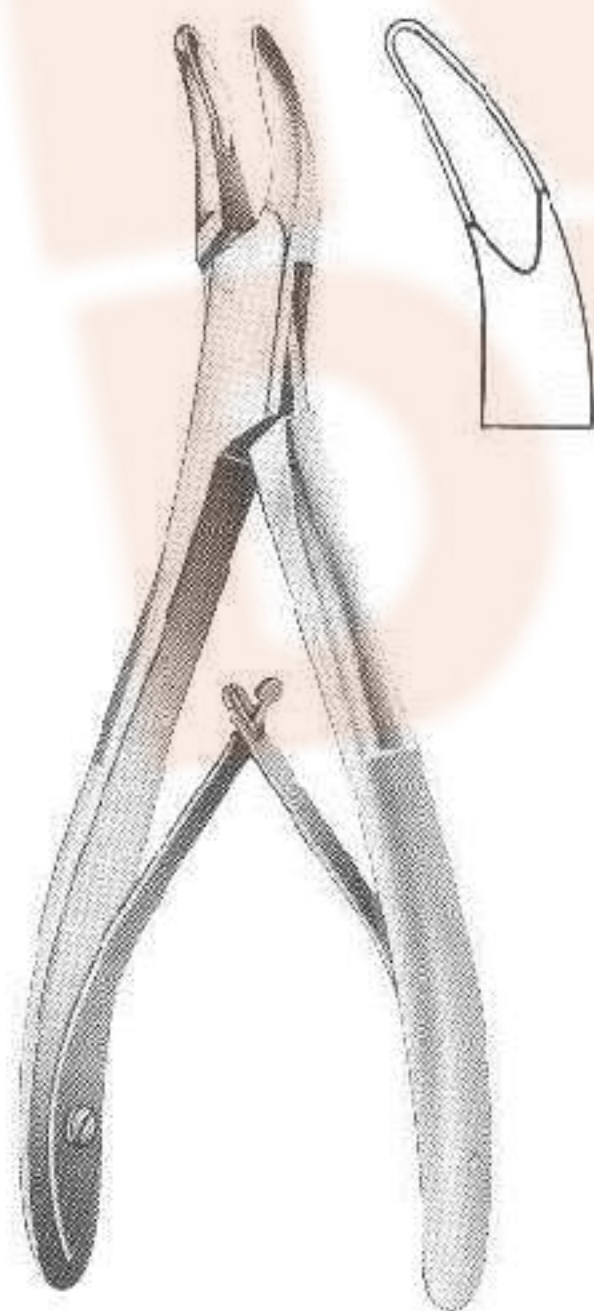

3003
Mead
14 cm, 5 1/2"

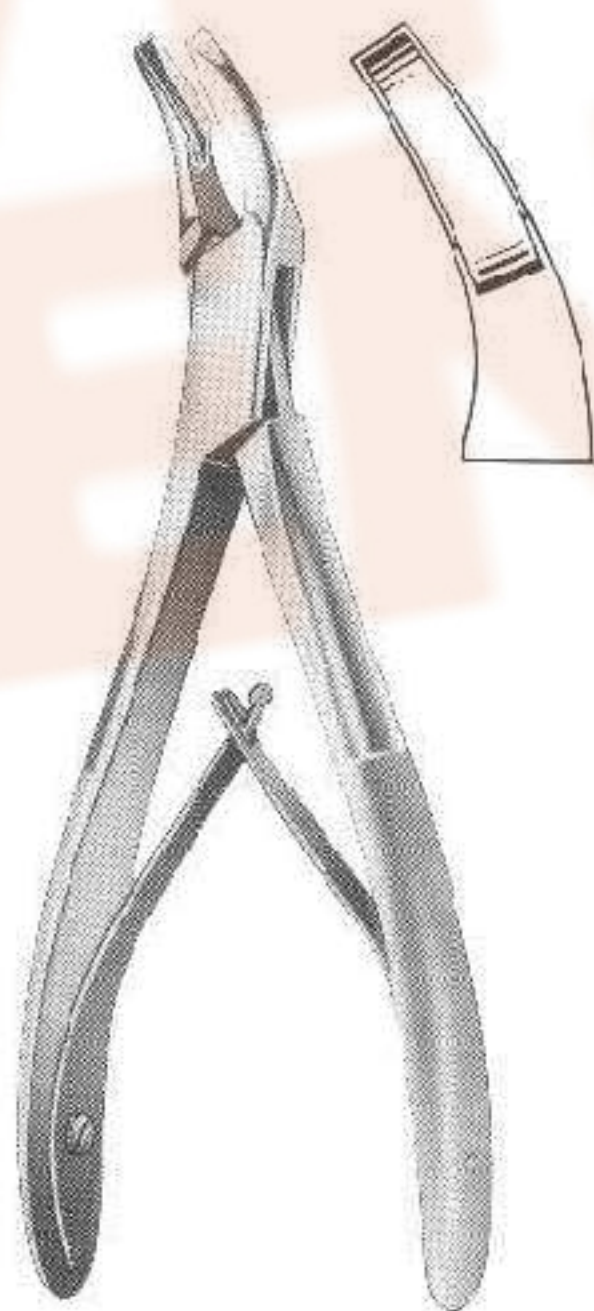

3004
Mead
17 cm, 6 3/4"

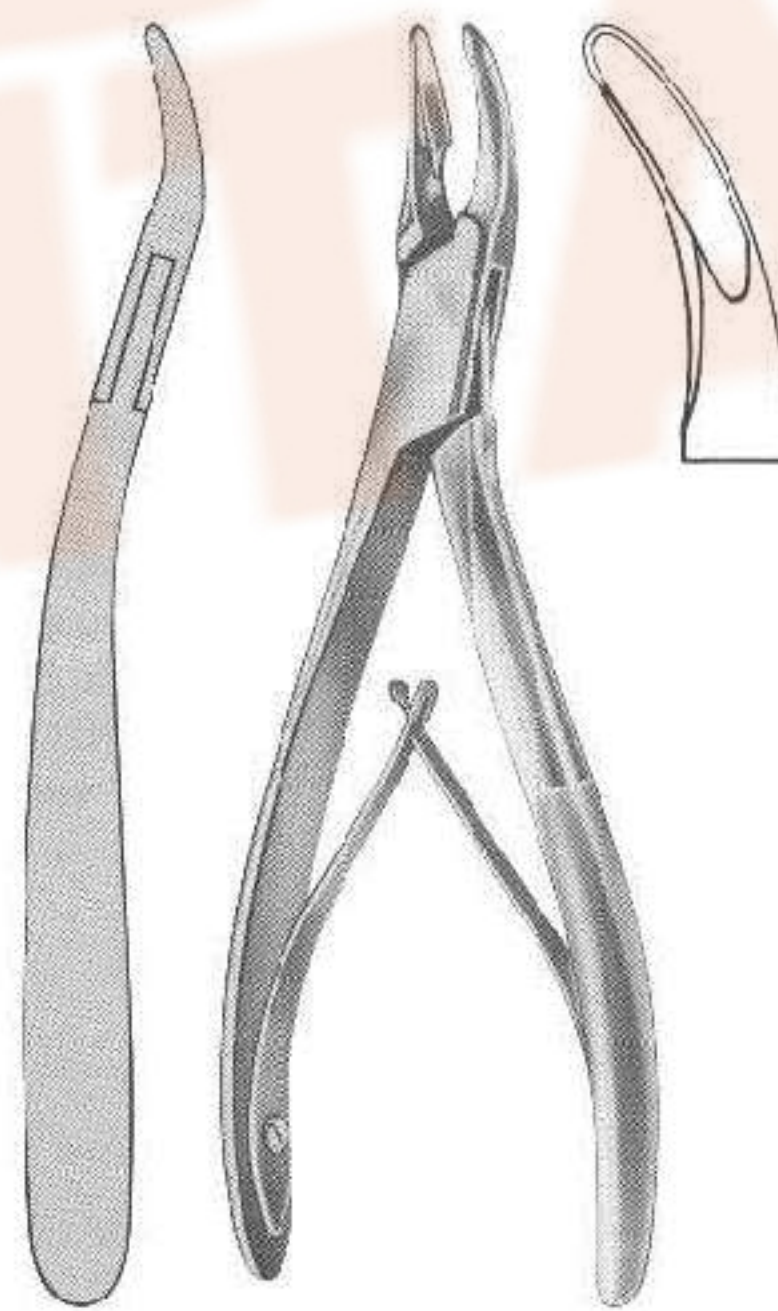

3005
Schell
17 cm, 6 3/4"



Bone Rongeurs



3006
Luer
15 cm

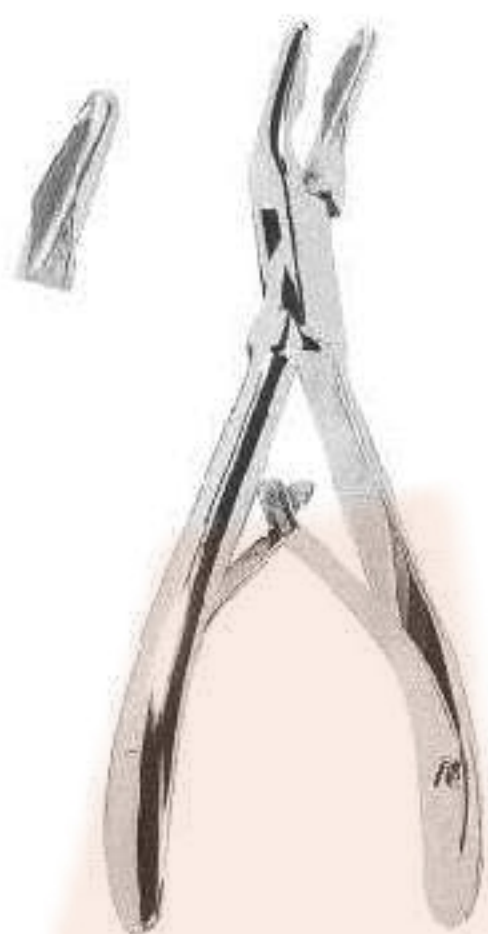

3007
Friedman
14 cm



3008
Mini Friedman
12 cm



3009
Goldman-Fax
10 cm



3010
Blumenthal
15 cm

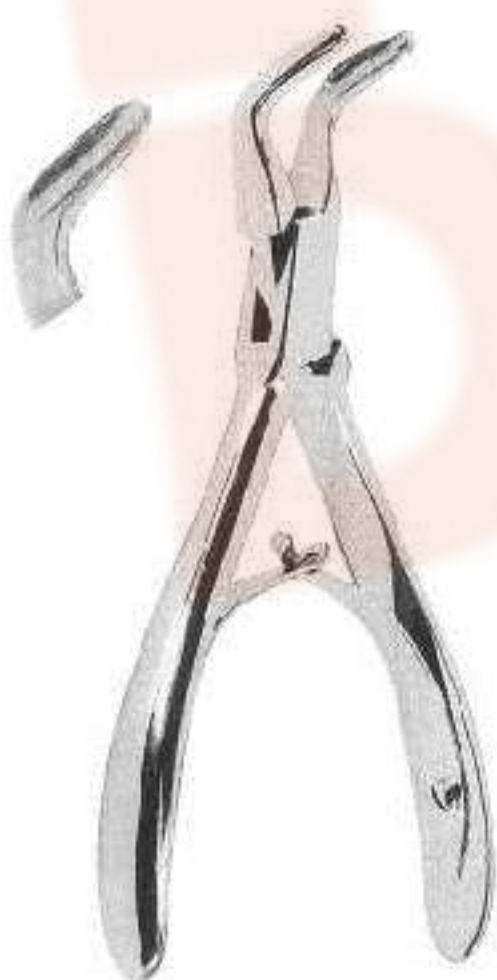

3011
Blumenthal 45
14,5 cm



3012
Blumenthal 90
14 cm

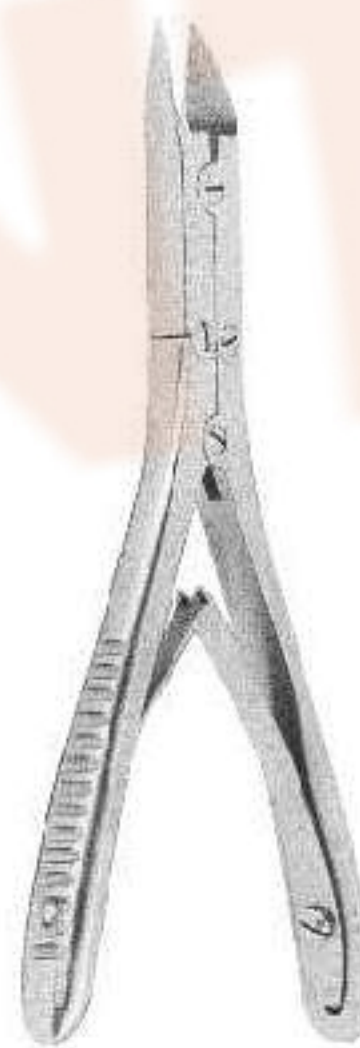

3013
Bohler
15 cm



3014
Kerrison
15 cm



Rongeurs

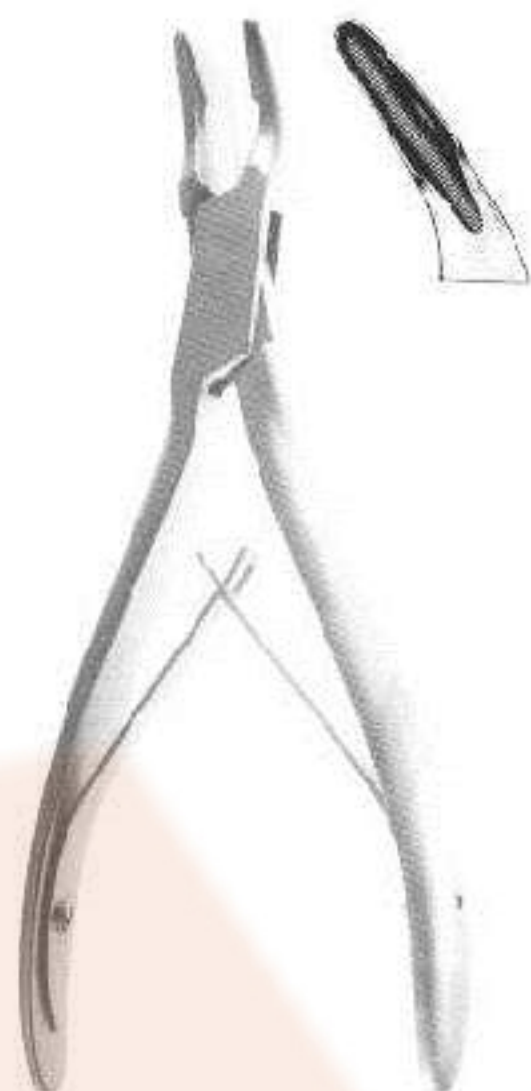

3015
Blumenthal
16 cm, 6 1/4"

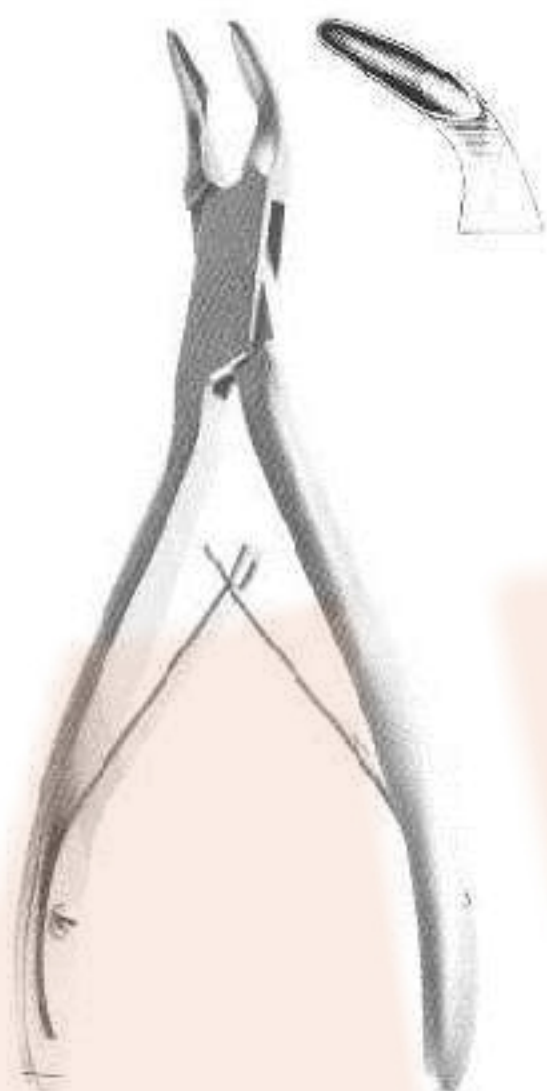

3016
Blumenthal
16 cm, 6 1/4"

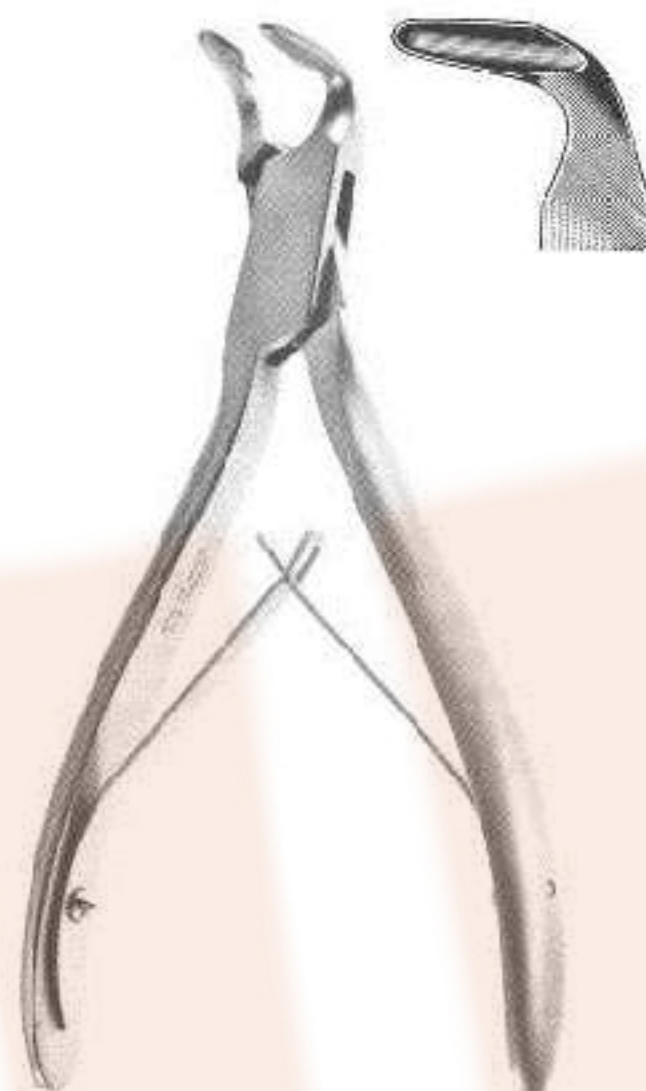

3017
Blumenthal
16 cm, 6 1/4"

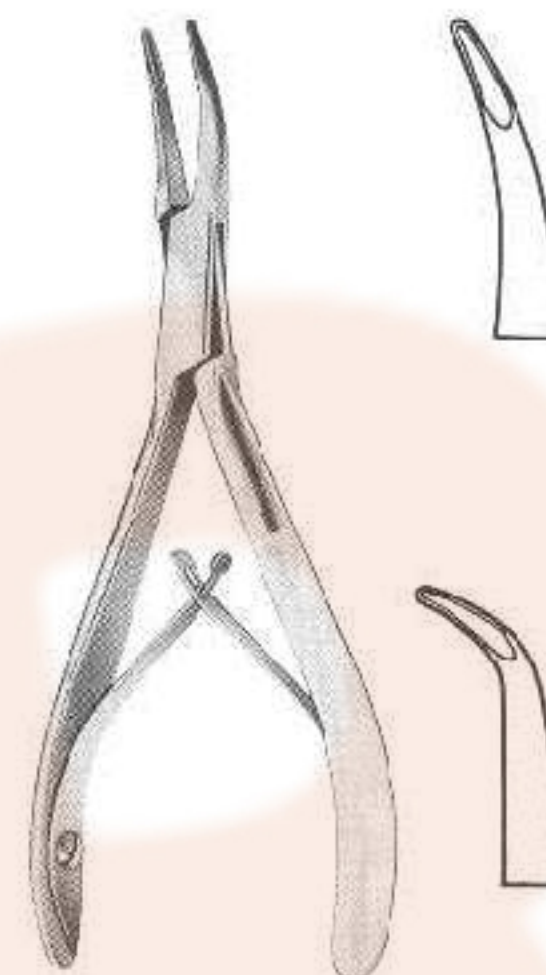

3018
Kleinert-Kutz
14 cm, 5 1/2"

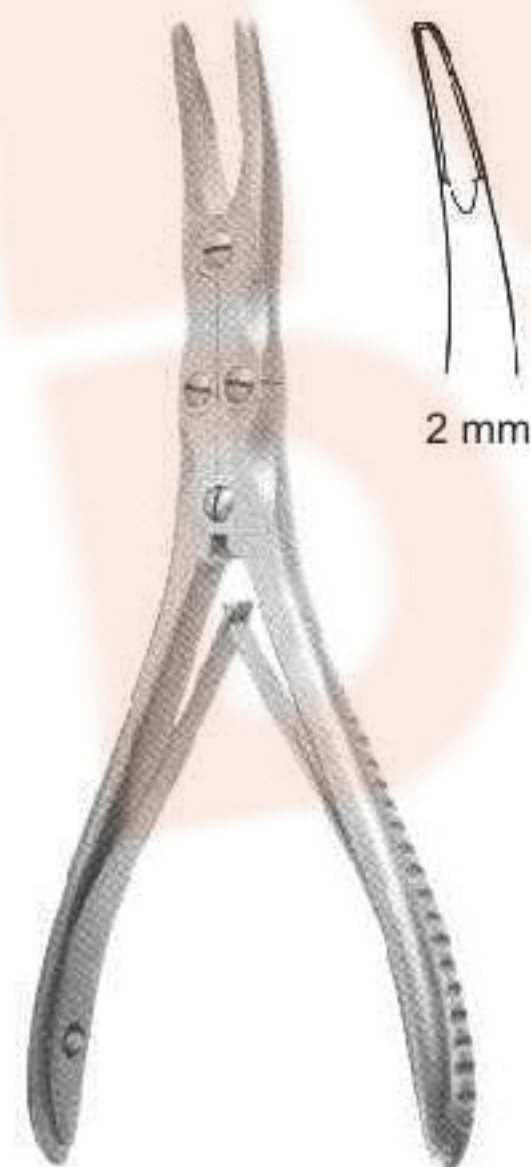

3019
Ruskin-Mini
15 cm

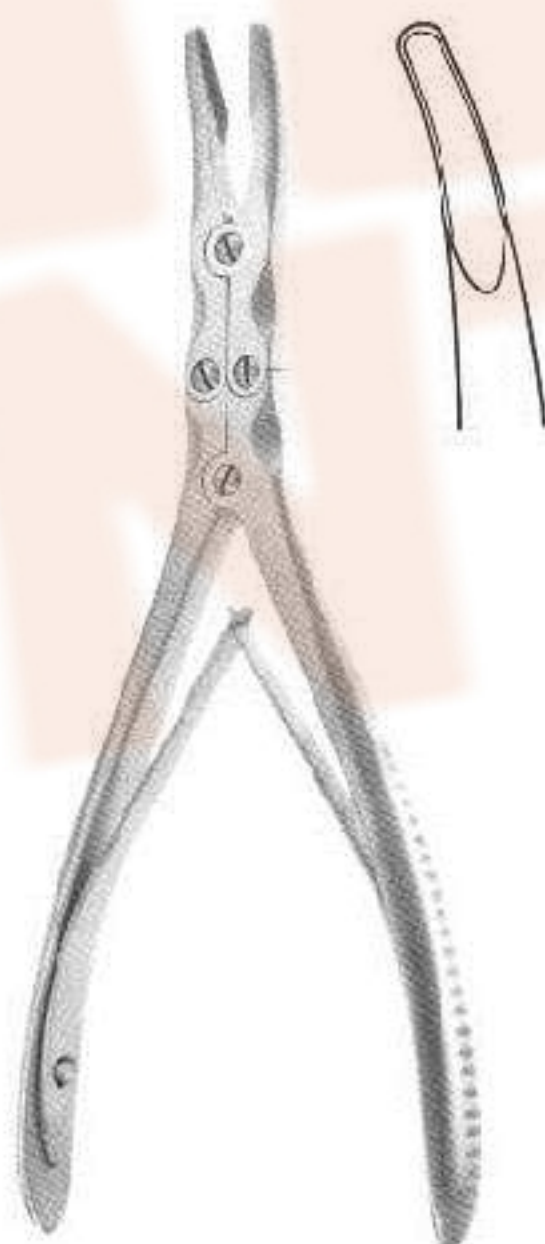

3020
Beyer
18 cm, 7 1/8"



3021
Zaufal-Jansen
18 cm, 7 1/8"



Rongeurs

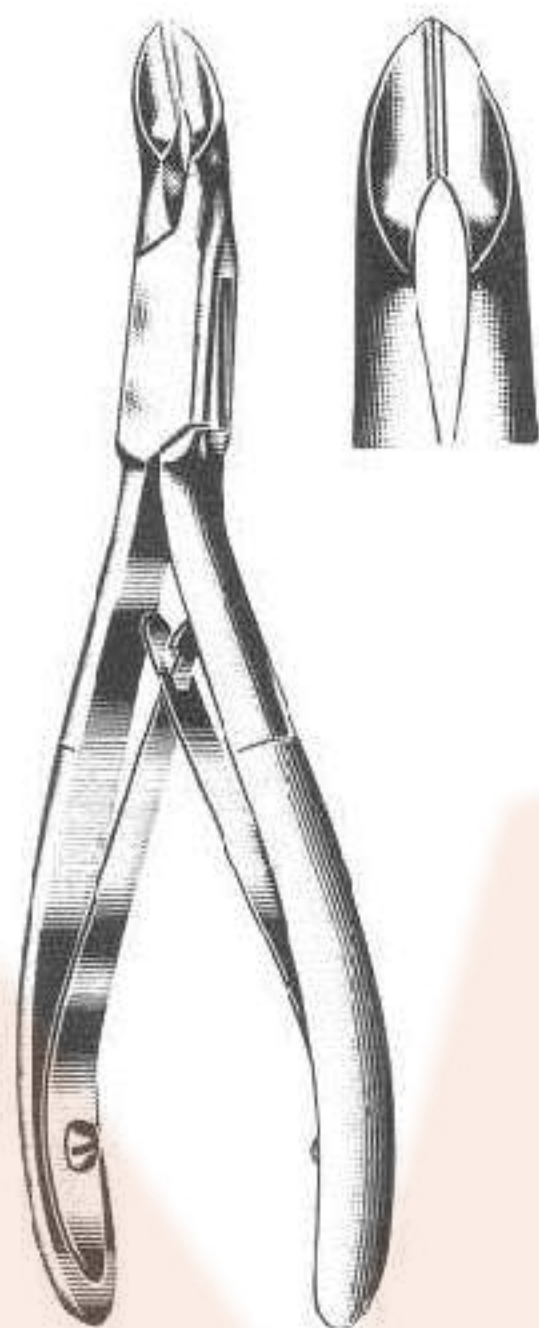

3022
Niro
No. 5 S, 14 cm, 5 1/2"



3023
Cleveland
No. 5 S, 17 cm, 6 3/4"

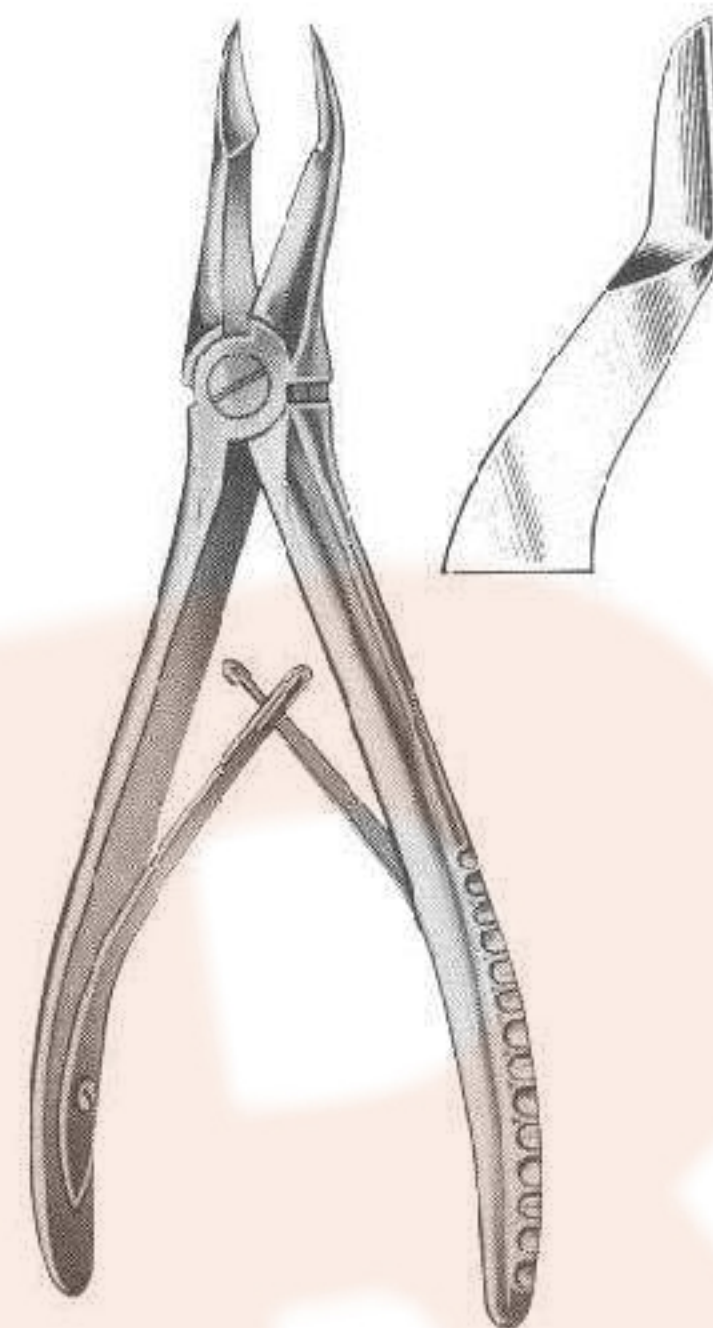

3024
No. 18, 15 cm, 6"

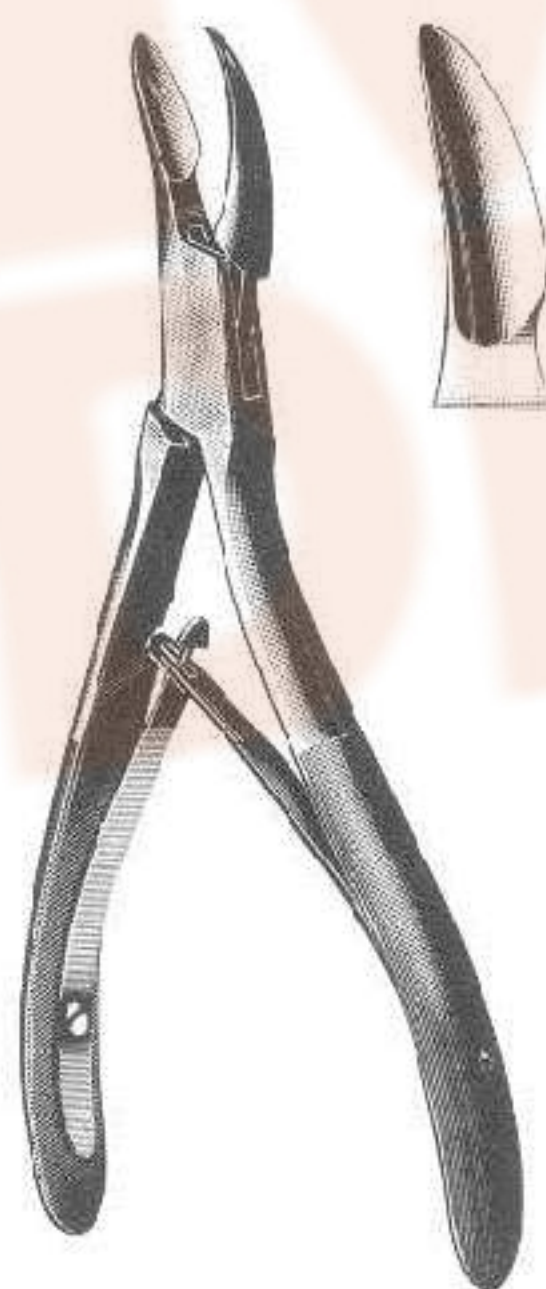

3025
Cleveland
16 cm, 6 1/4"

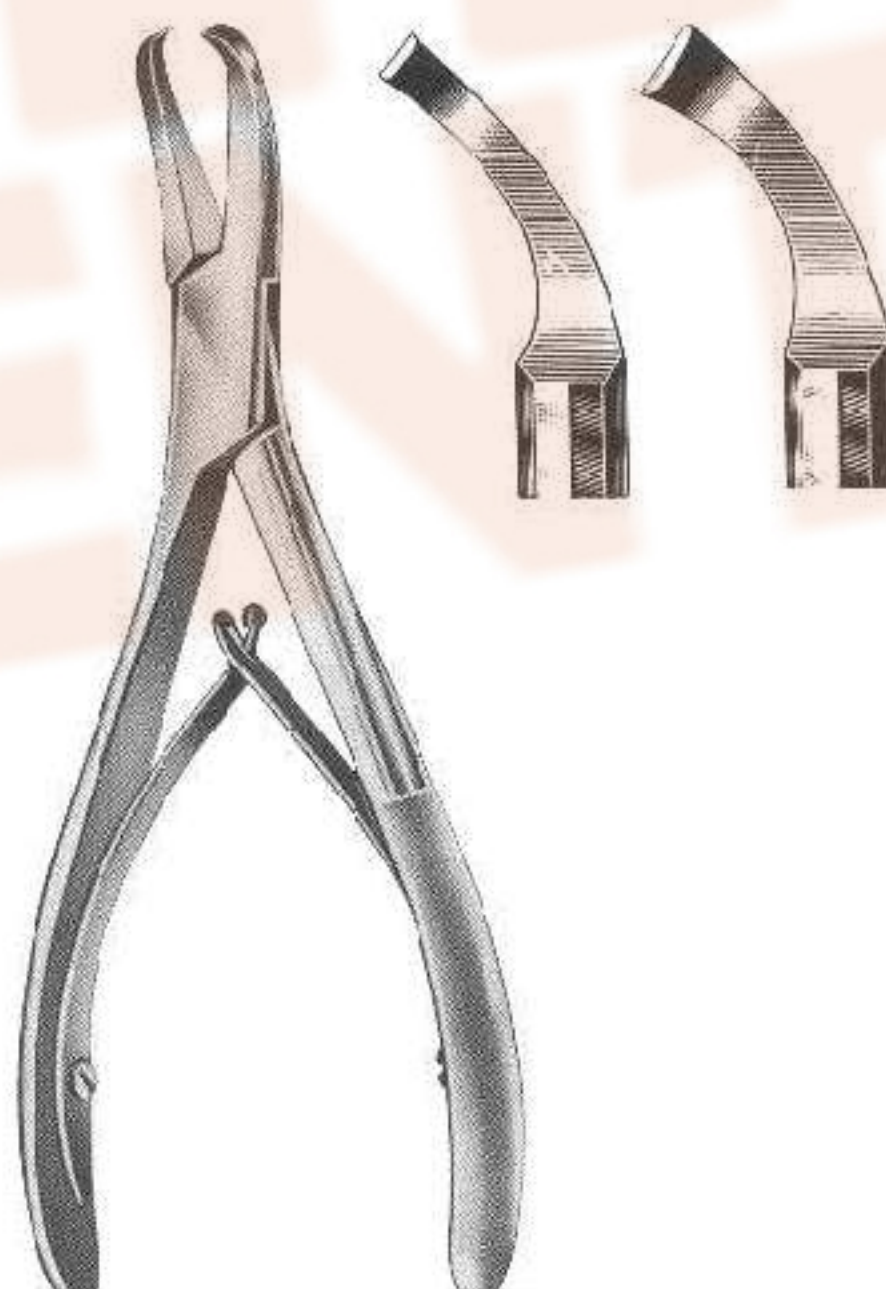

3026
Gardner
16 cm, 6 1/4"

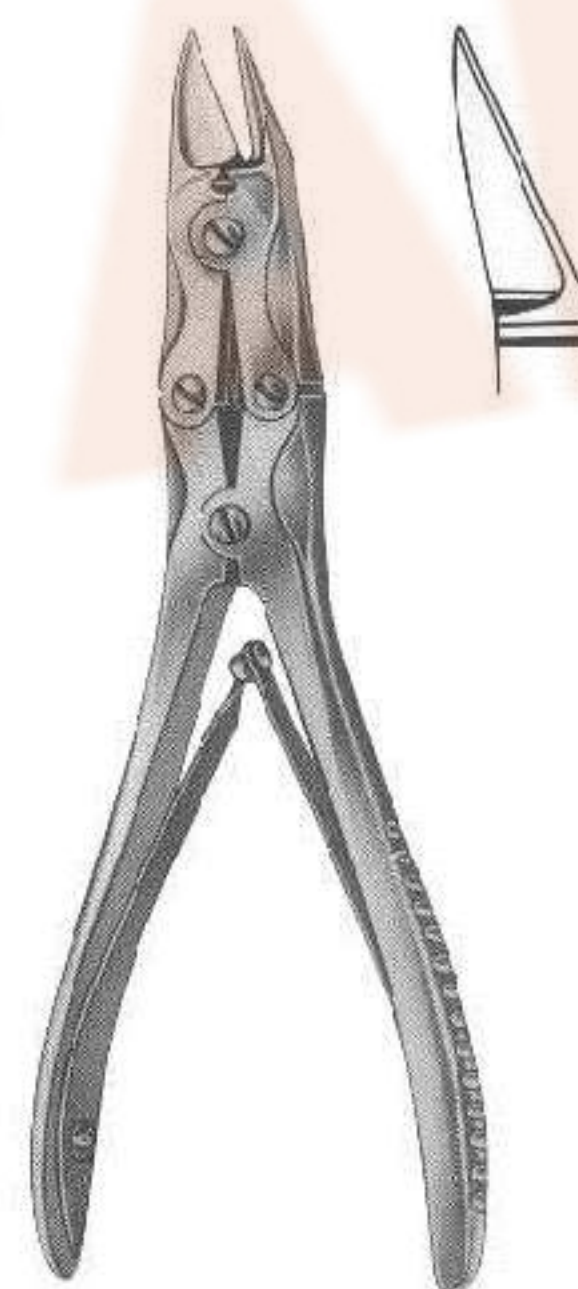

3027
Liston-mini
15 cm, 6"



Bone Elevators

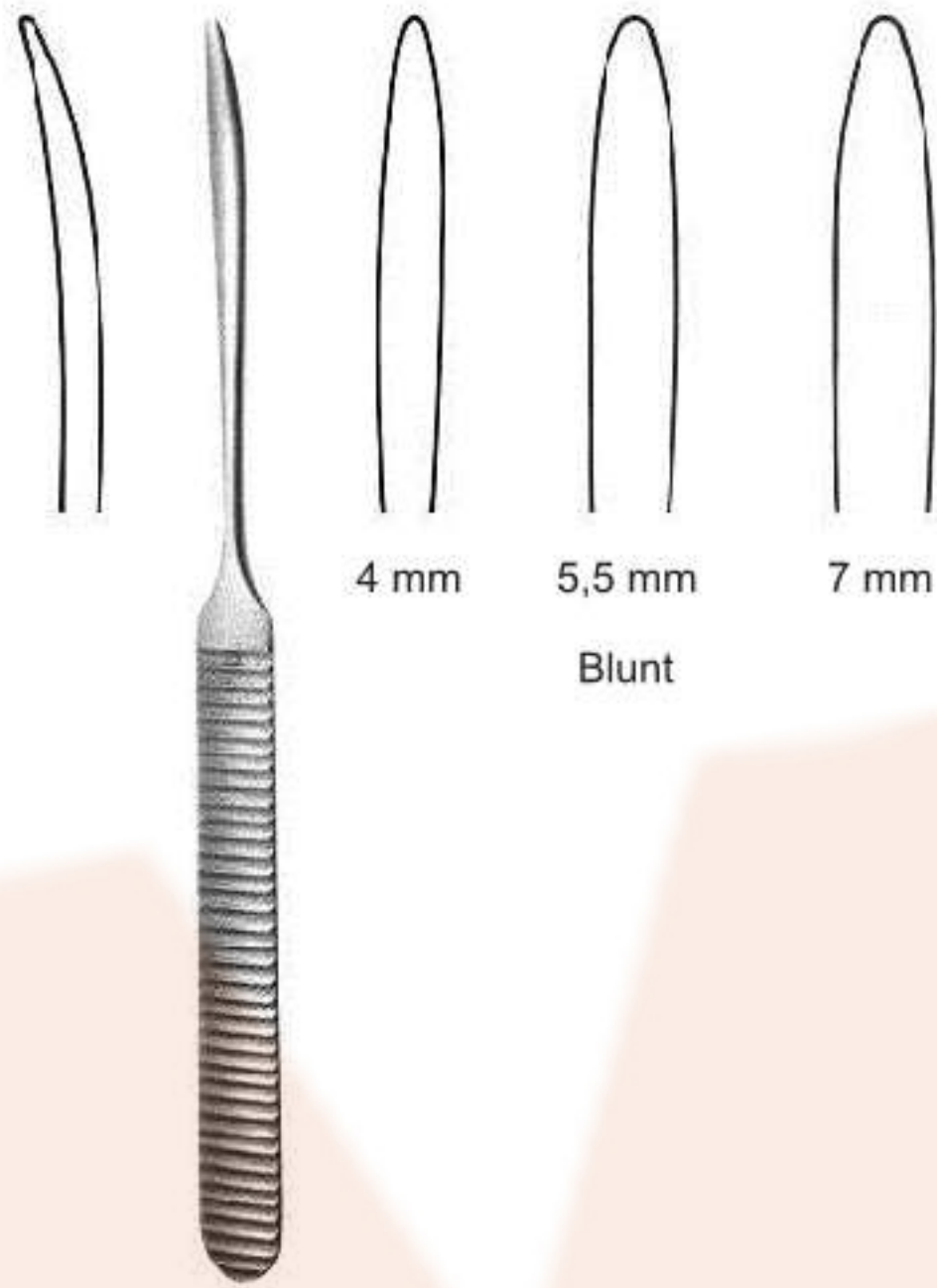

3100
Williger
16 cm, 6 1/4"

4 mm
5,5 mm
7 mm
Blunt



3101
Henahan
17 cm, 6 3/4"

10 mm
12 mm
15 mm
Semi-Sharp

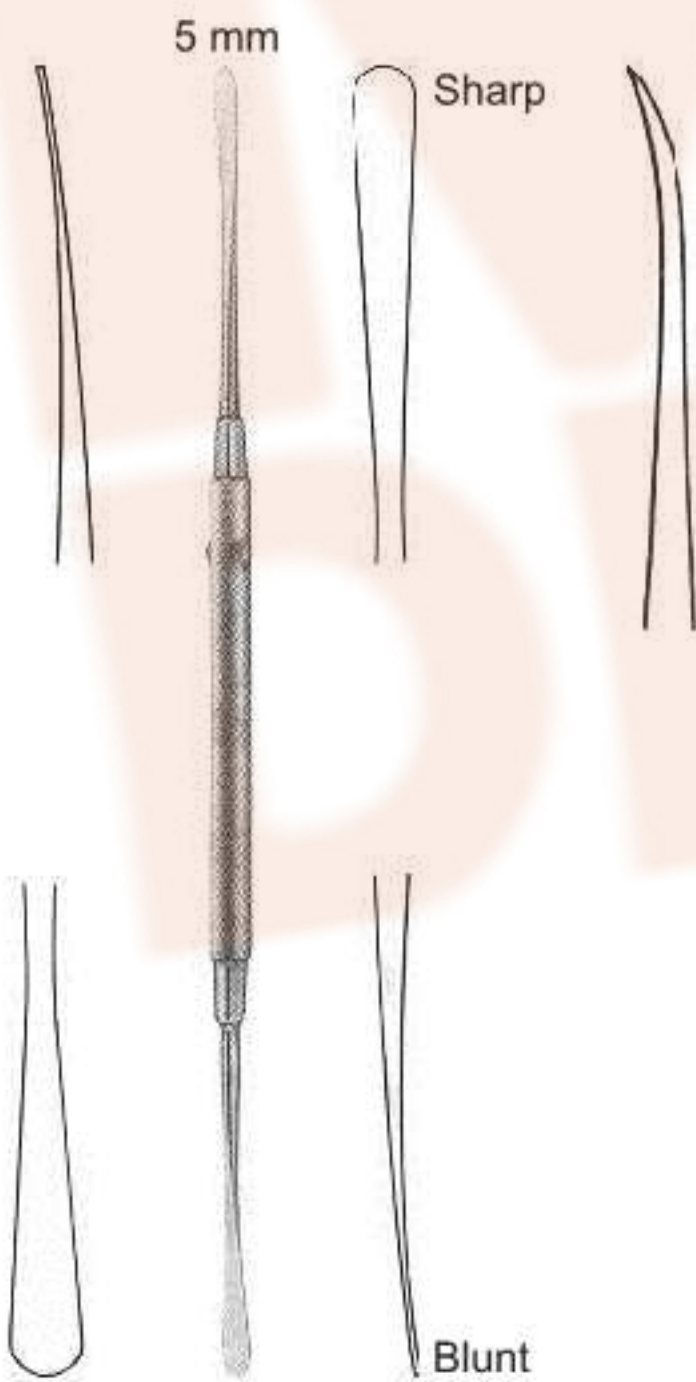

3102
Freer
19 cm, 7 1/2"

5 mm
Sharp
Blunt

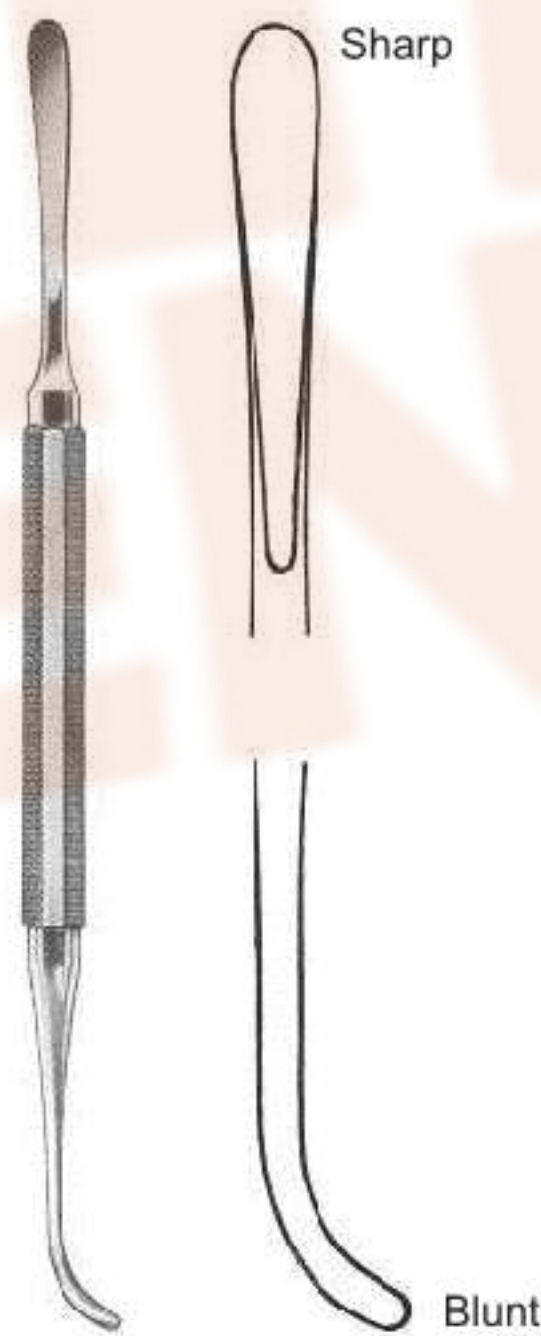

3103
Bennet
17 cm, 6 3/4"

Sharp
Blunt

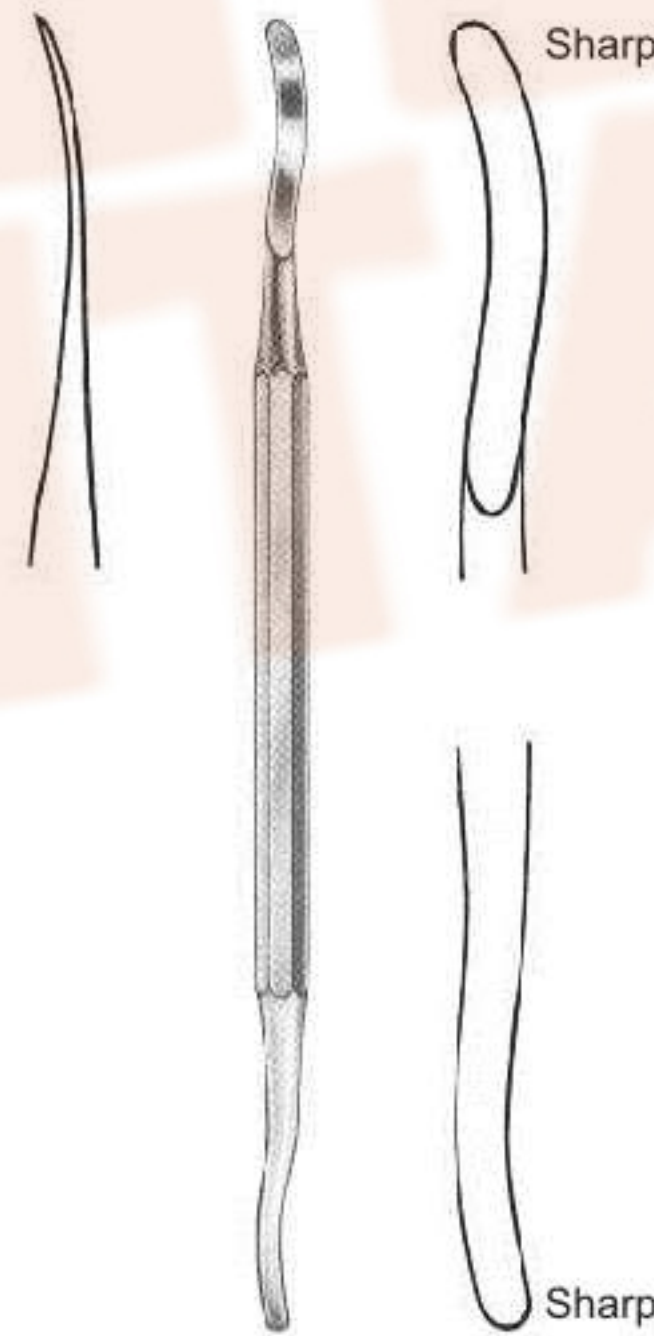

3104
Seldin
19 cm, 7 1/2"

Sharp
Sharp

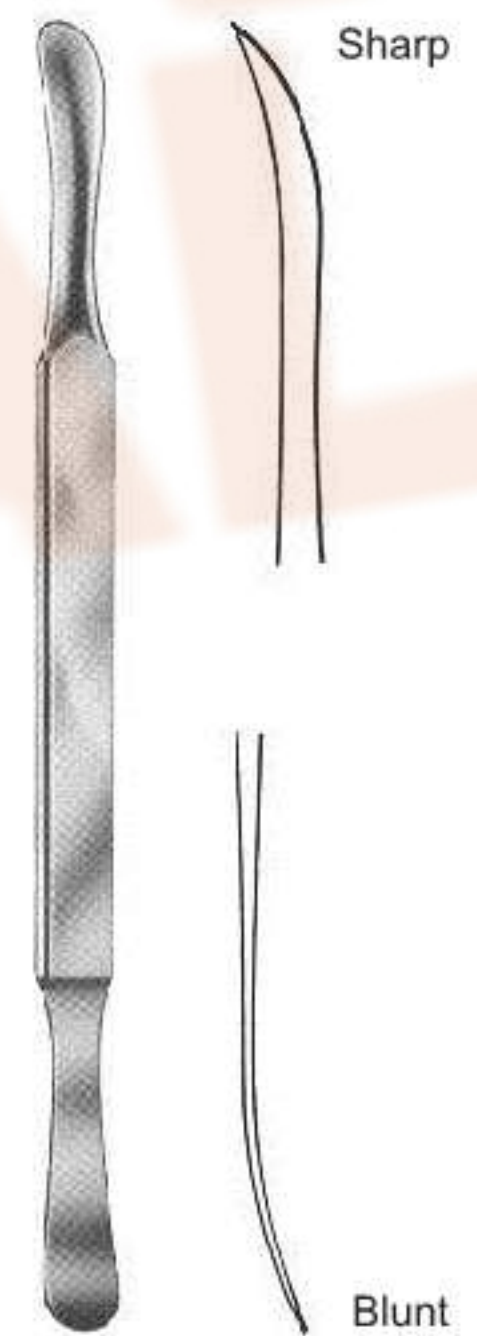

3105
Seldin
19,5 cm, 7 3/4"

Sharp
Blunt



Bone Files and Chisels



Buckley
15 cm, 6"



3106
No.1
3mm



3107
No. 2
4mm



3108
No. 3
5mm



3109
No. 4
4mm



3110
No. 5
4mm



3111
Killian
16 cm, 6 1/4" 5 mm

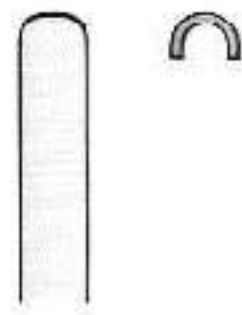

3112
Killian-Claus
16 cm, 6 1/4" 5 mm

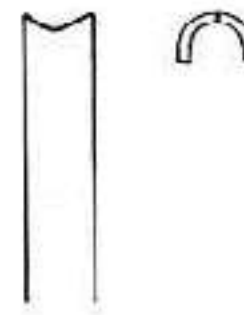

Obwegeser



3113
2,5 mm

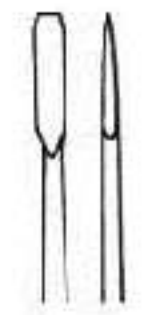

3114
4 mm



3115
Miller
No.10C



3116
Miller
No.11C



3117
Miller
No.12C



3118
Miller
No.13C





Pinze per formare loops
Loops forming pliers



3200
Adams
Adams pliers for bending
wires up to 0,7mm. (.28").

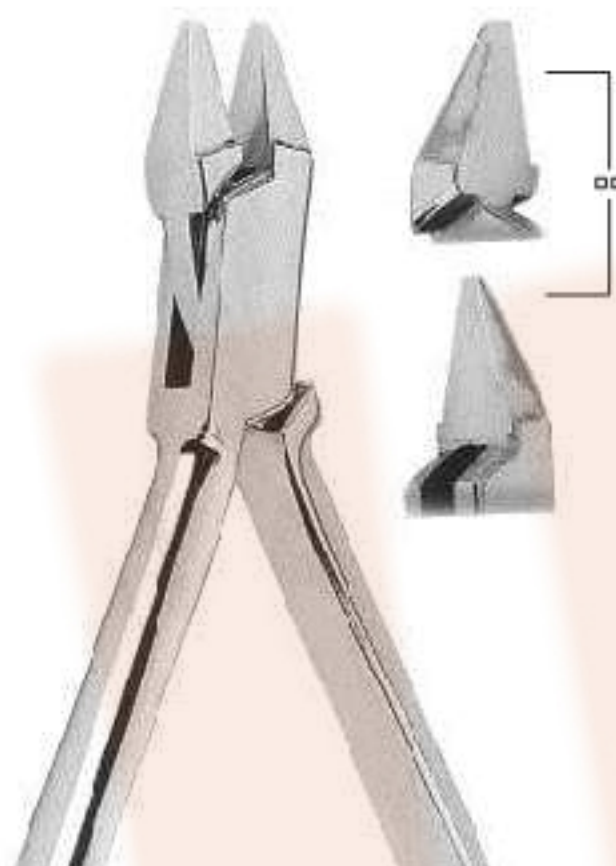

3201
Adams
Adams pliers for bending
wires up to 0,7mm. (.28").

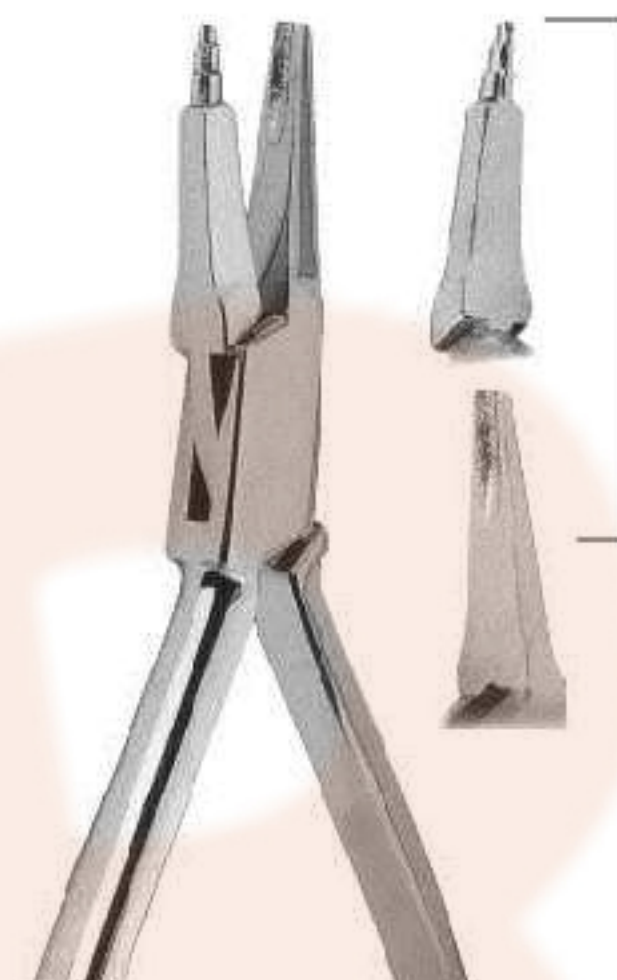

3202
Adams
Tweed loop forming pliers.
For forming loop in wires up
to 0,56 mm. (.22").

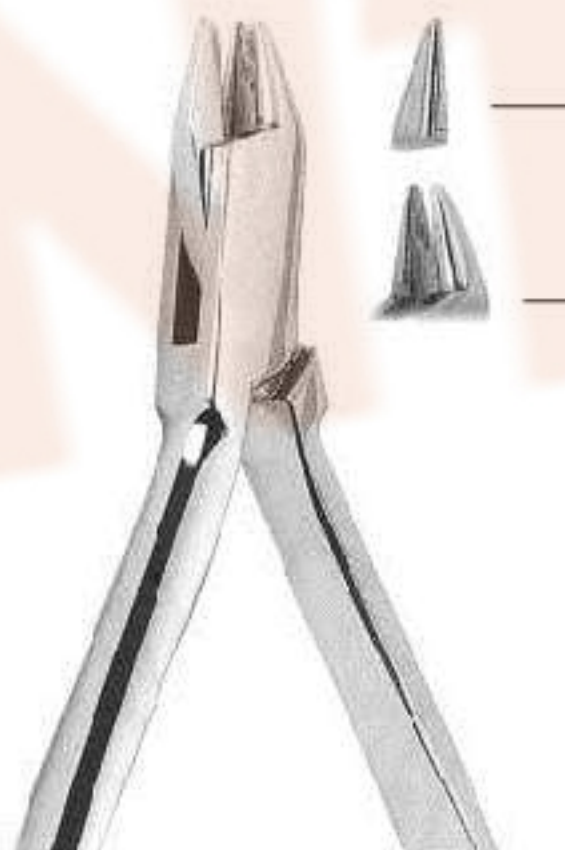

3203
Adams
Aderer three jaws bending
pliers. For wires up
to 0,7 mm. (.28").

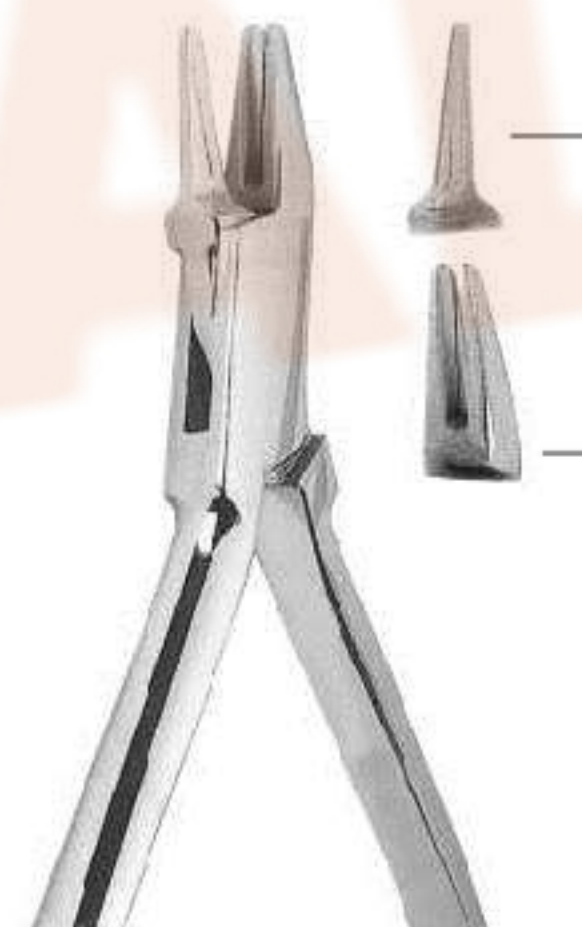

3204
Adams
Aderer three jaws bending
pliers. For wires up to 0,7 mm.
(.28").



Ligature Cutter Pliers



3205

Micro-miniature light wire cutter. It cuts soft ligature wires. For use in caso of limited access. Caution: maximum cutting capacity: soft ligature wire up to 0,30 mm. (.012").

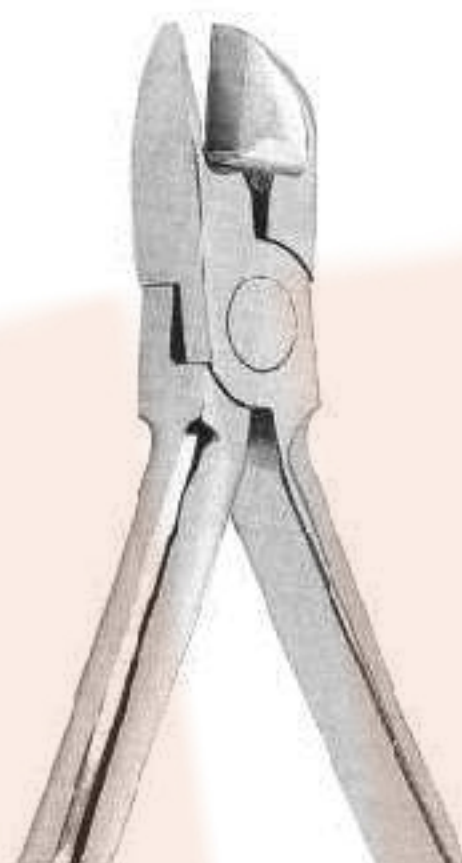

3206

Wire cutter. For ligature wires and pins. It is strong enough to bend archwire ends after distal cutting. Maximum cutting capacity up to 0,56 x 0,7 mm. (.022" x .028").

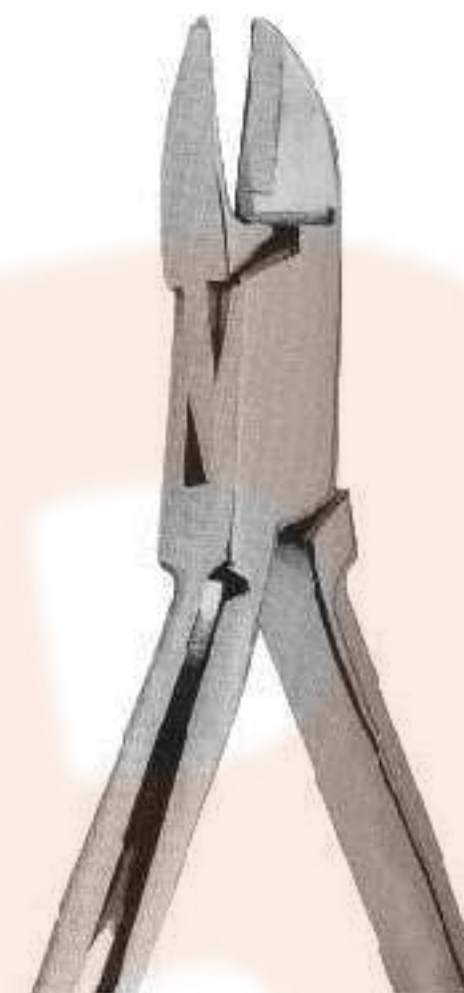

3207

Wire cutter. For ligature wires and pins. It is strong enough to bend archwire ends after distal cutting. Maximum cutting capacity: up to 0,9 mm. (.036").

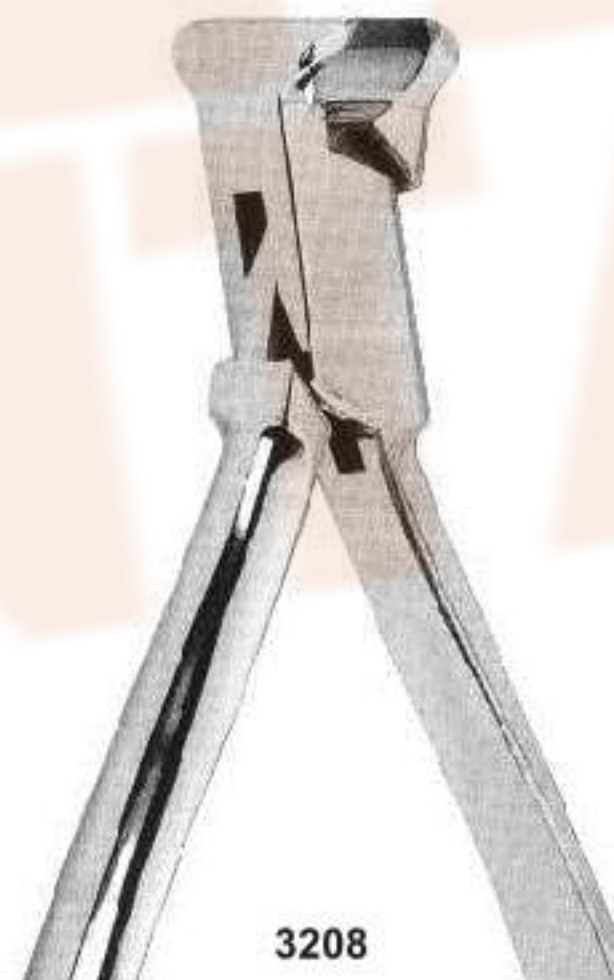

3208

Wire cutter. For ligature wires and pins. It is strong enough to bend archwire ends after distal cutting. Maximum cutting capacity: up to 1,5 mm. (.044").



Pinze per formare laboratorio
Laboratory pliers



3209

Flat nose pliers with smooth beaks for bending wires up to 0,7 mm. (.028").

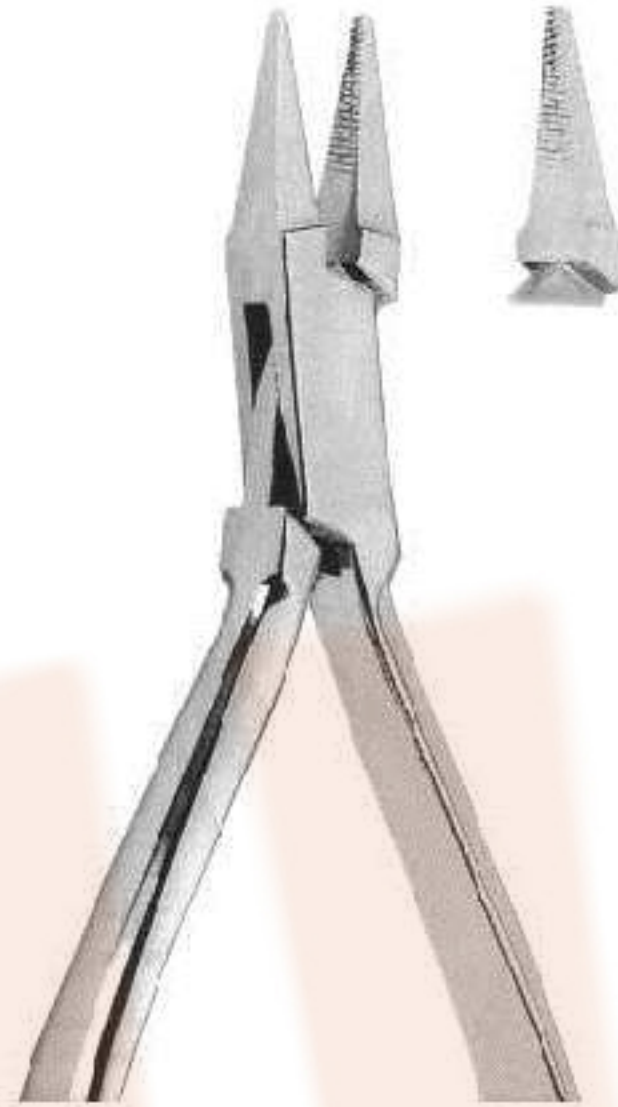

3210

Bending wires up to 0,7 mm. (.028").

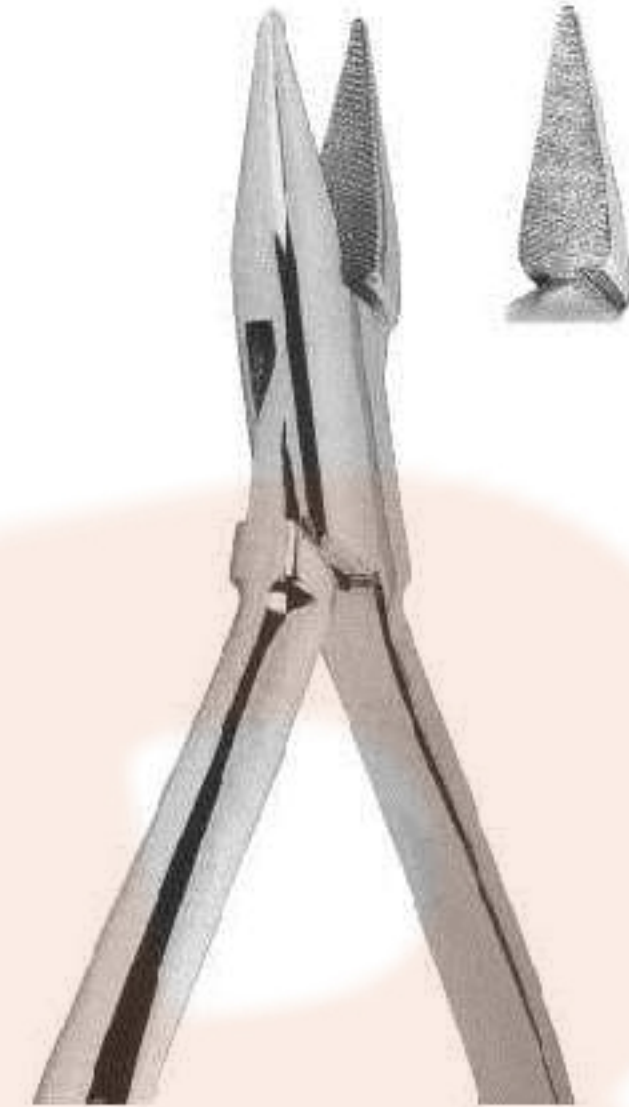

3211

Bending wires up to 0,7 mm. (.028").

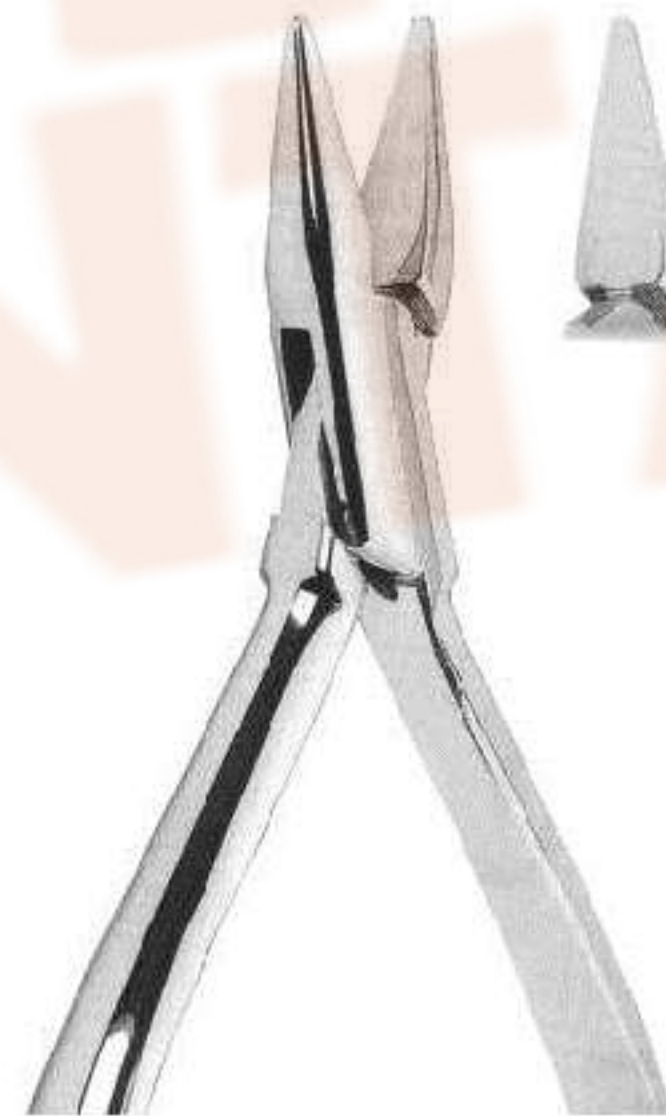

3212

Bending wires up to 0,7 mm. (.028").



Pliers for Orthodontics



3213
Nance

Nance loop closing pliers, for bending of stop loops and special for Adams' clasps. Wires up to 0,7 mm. (.028").

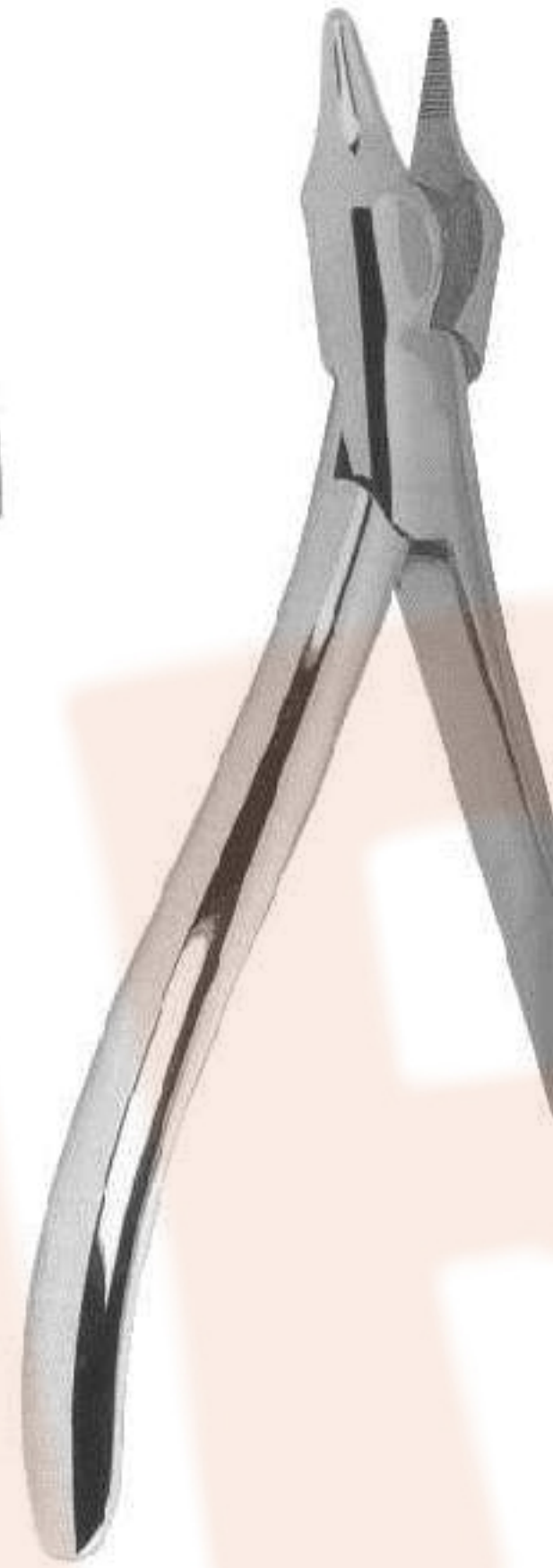
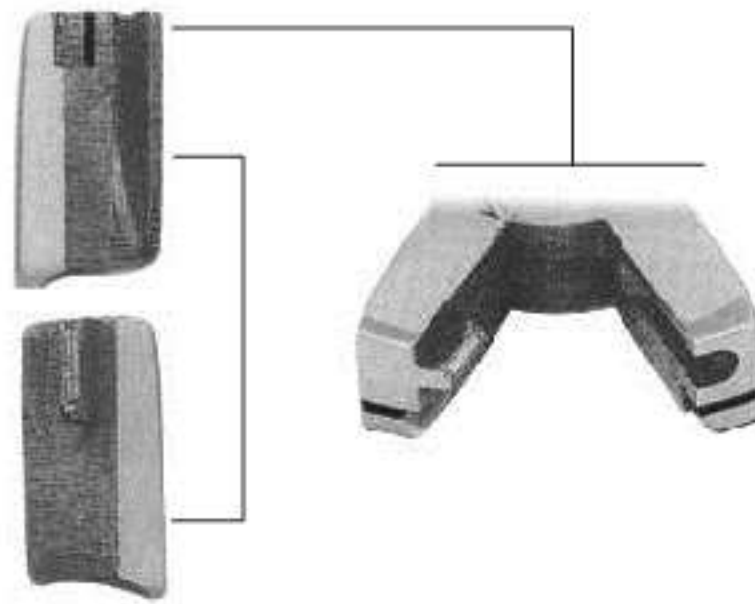

3214
Nance

Universal pliers for bending wires up to 0,9 mm. (.035") or cutting up to 0,7 mm. (.028").

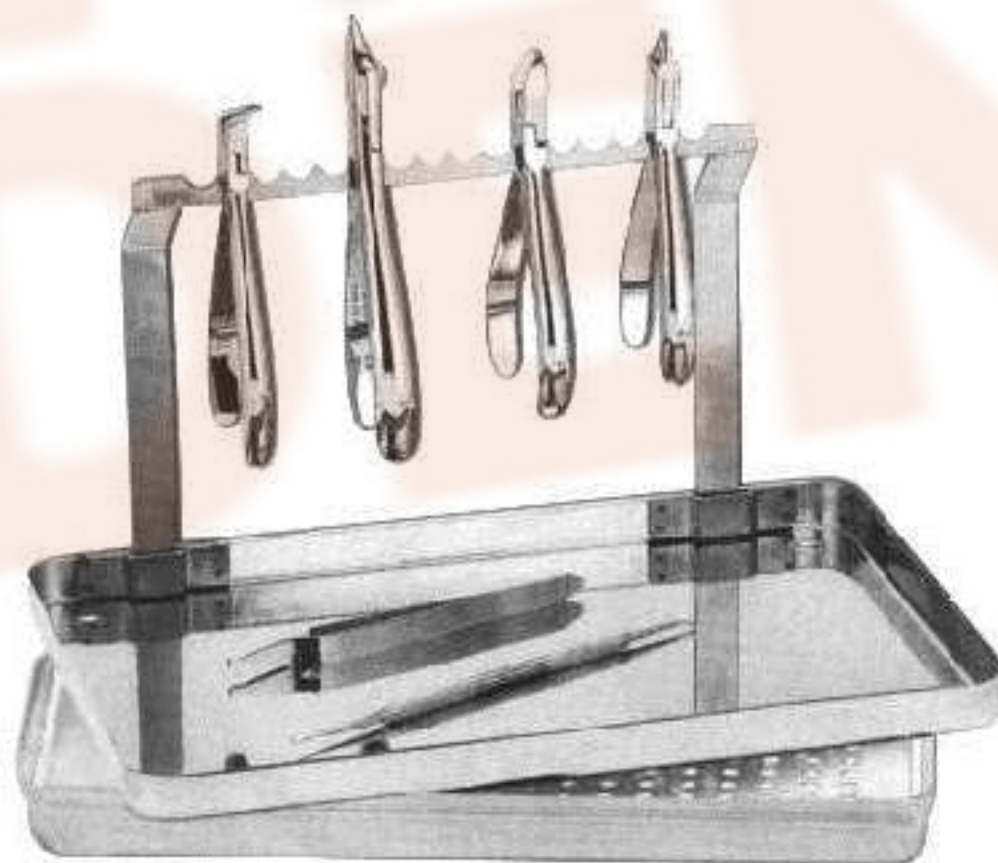

3215

Stainless steel pliers tray standard dimensions



3216
Universal

Universal pin roughening, cutting and bending pliers. Forwires up to 0,9 mm. (.035"). Will cut wires up to 0,7 mm. (.028").



Utility and specialty pliers

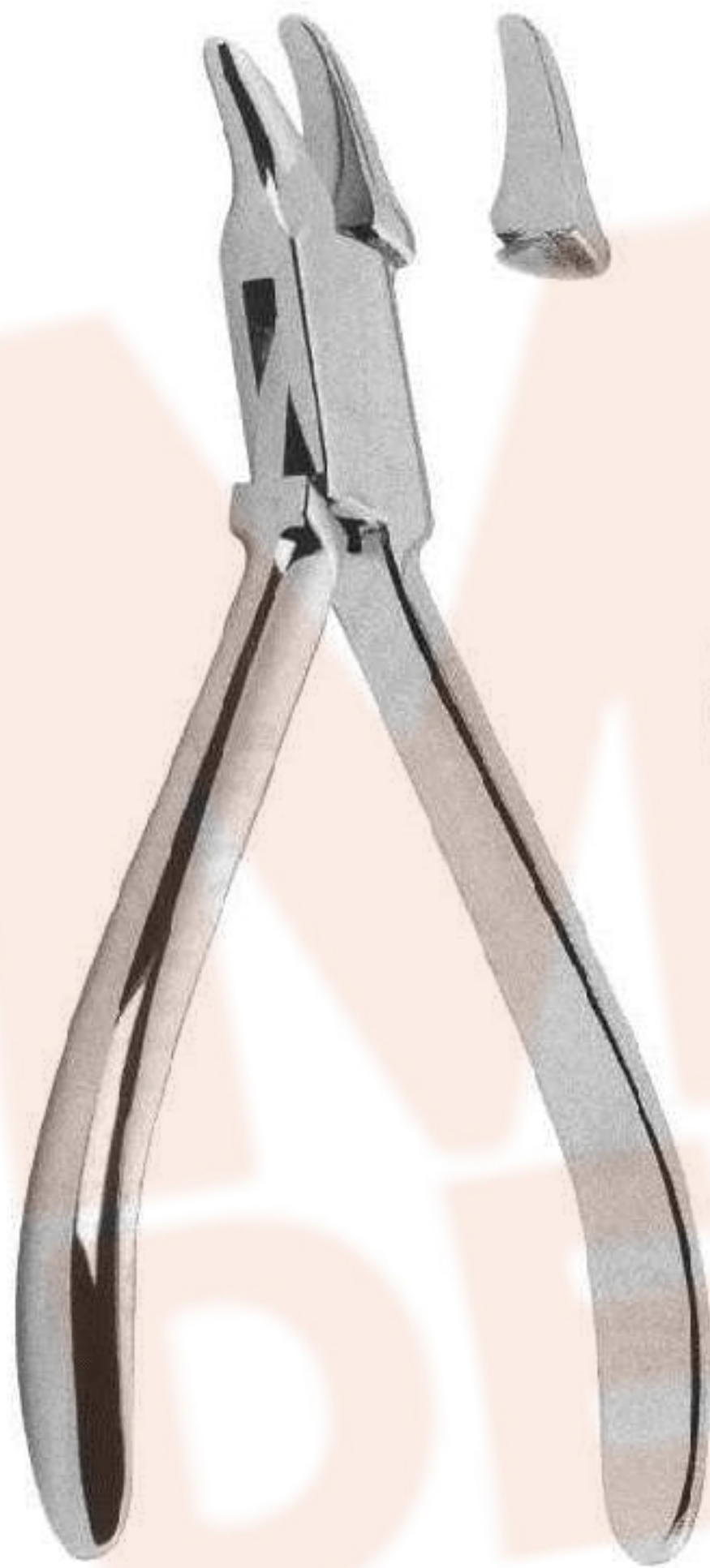

3217
Reynolds

Reynolds contouring pliers.

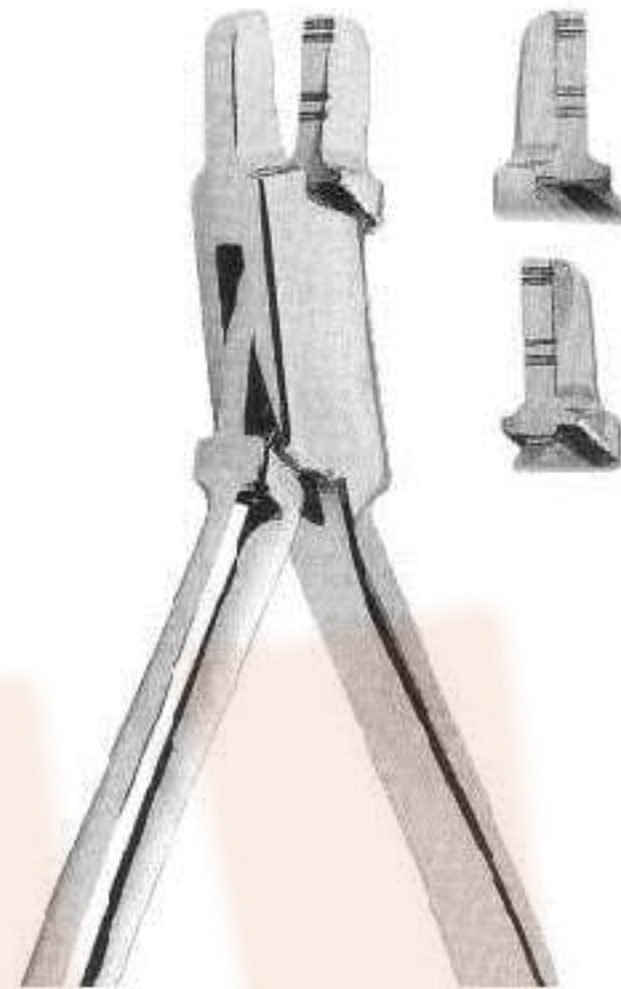

3218
Reynolds

Lingual arch pliers used to form double and triple back bends in 0,7 mm (.028") or 0,9 mm (.035") wire for insertion in lingual sheaths.

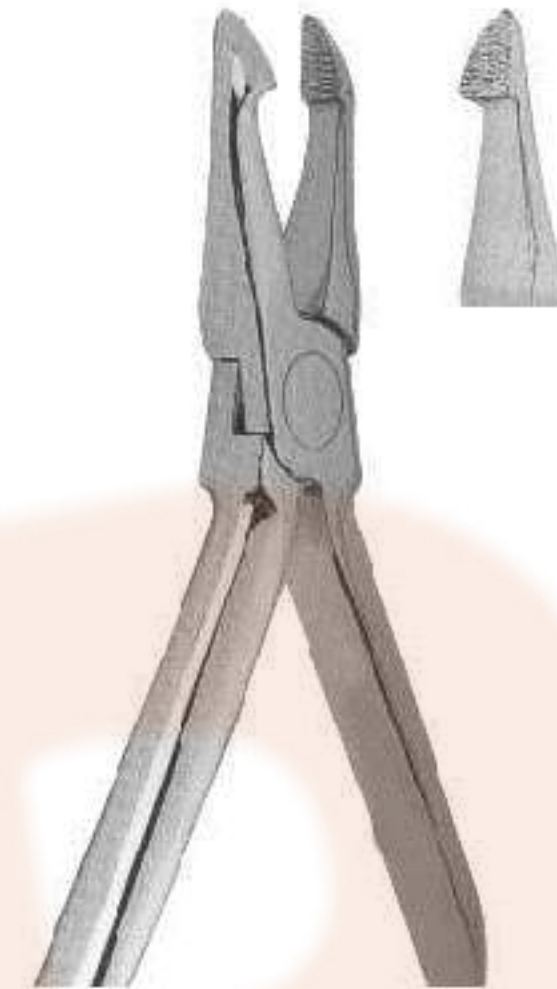

3219
Weingart

Weingart pliers with serrated points.

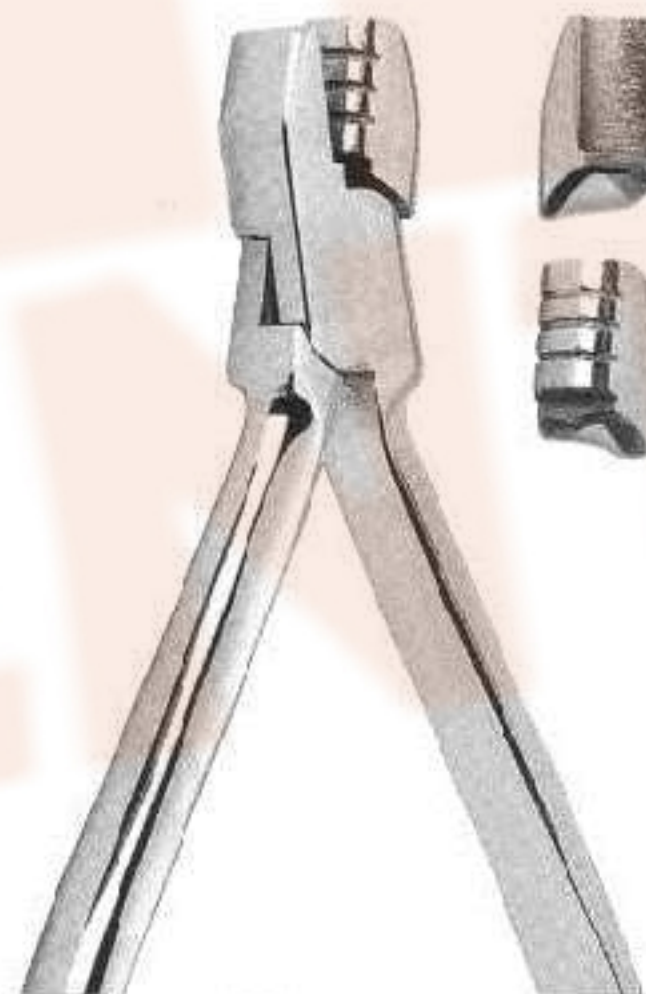

3220
De La Rosa

De La Rosa arch forming pliers. Designed to form and contour arch wires on round or rectangular wire. The beak has grooves of 0,4 mm (.016"), 0,46 mm (.018") and 0,56 mm (.022").

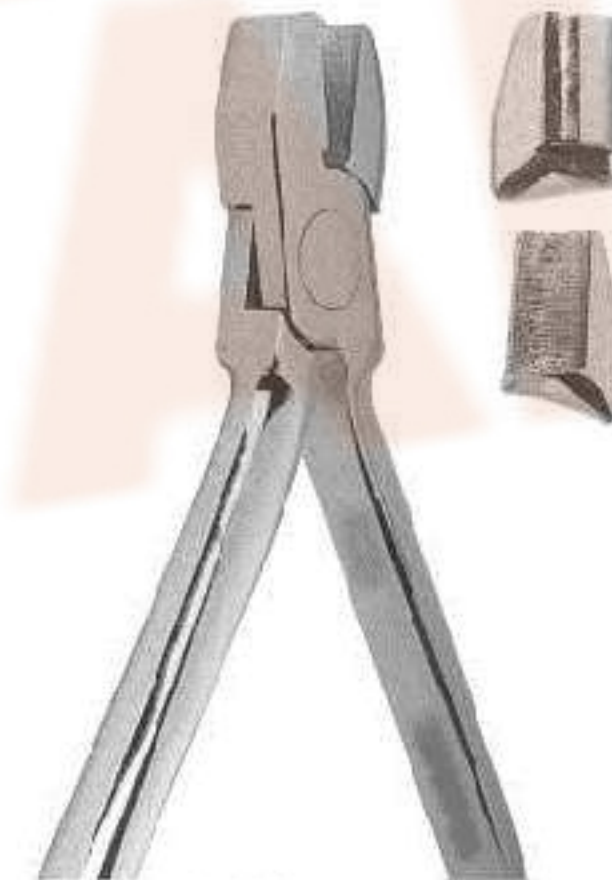

3221
De La Rosa

Arch forming pliers with a non grooved contouring surface the forming of precise arches.



Loop formare pliers



3222
Waldsachs

Waldsachs universal pliers for bending wires up to 1,0 mm. (.039") or cutting up to 0,7 mm. (.028").



3223

Round and Concave pliers for loop forming and bending of thin round and square wires up to 0,5 mm. (.020").



3224
Tweed

Tweed loop Forming Pliers. For round or rectangular wires up to 0,56 x 0,7 mm. (.022" x .028"). Replaceable cylindrical beak with three sizes: 1,15 mm. (.045), 1,50 mm. (.059"), 1,90 mm. (.075"). Concave beak with slight parallel serrations, to keep the wire in proper position.

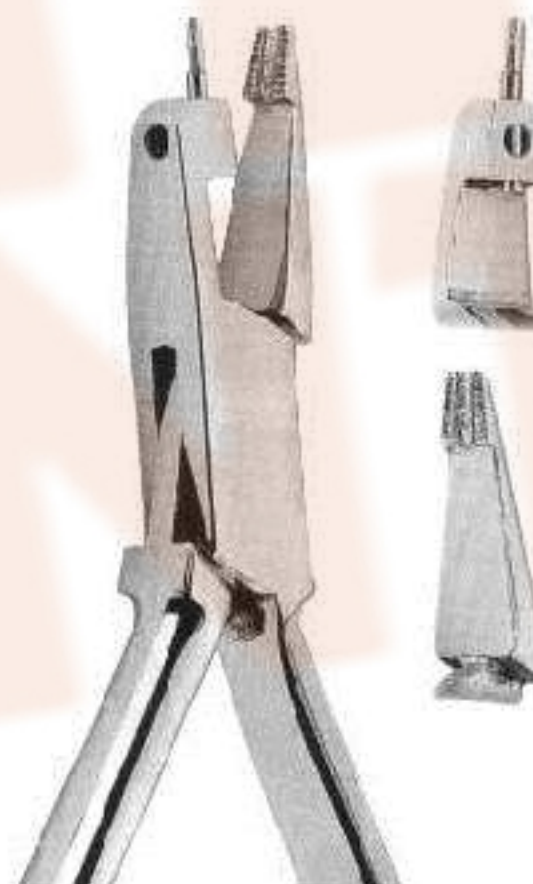

3225
Tweed

Tweed Loop Forming Pliers. For making perfect Omega Loops with round or rectangular wires up to 0,56 x 0,7 mm. (.022" x .028"). The concave beak is exactly the same as pliers 5809-1

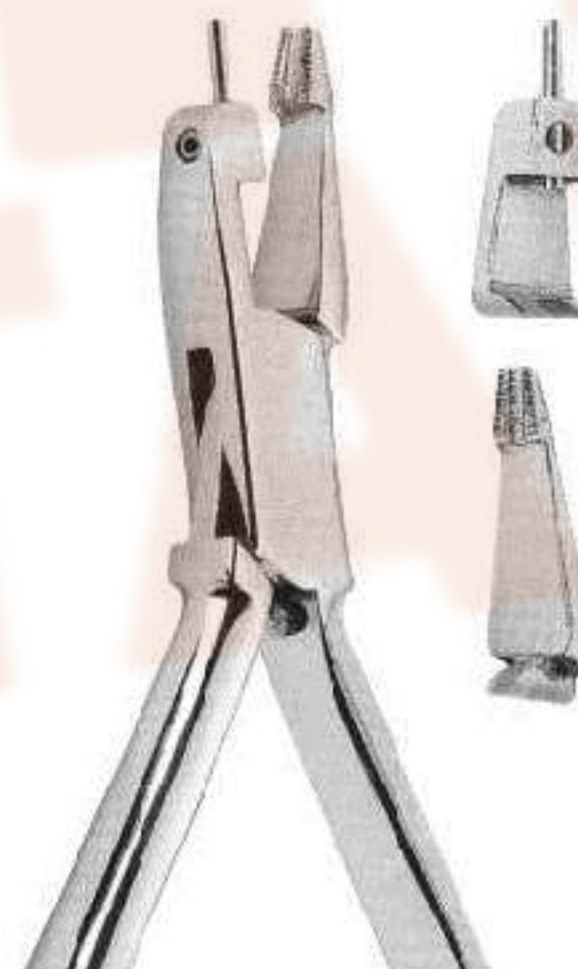

3226
Tweed

Single diameter loop forming pliers. Wire up to 0,56 x 0,7 mm. (.022" x 0.28"). Replaceable concave beak has only one diameter section of 1,50 mm. (.059").



Distal end cutters

D.B. bracket remover pliers



3227

Distal end cutter -safety hold- a precision cutter designed for distal arch cutting in the patient's mouth. It cuts hard wires end holds the loose distal end preventing any damaging of oral tissue. Maximum cutting capacity rectangular wires up to 0,56 x 0,7 mm. (.022" x .020").

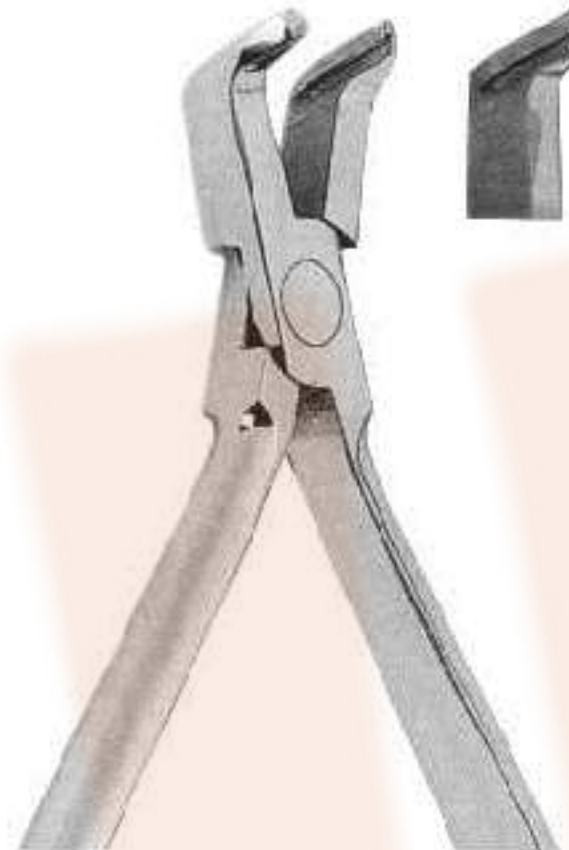

3228

Micro- distal end cutter - safety hold-. Similar to 3227



3229

Direct bonding bracket remover (wide). The removal grip firmly for easy incisal-gingival (vertical) use or, if needed, for mesial-distal (horizontal) use with the same ease.

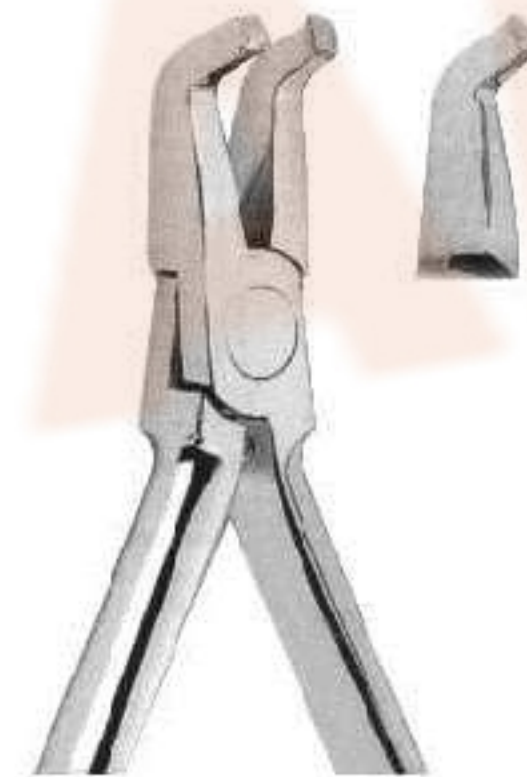
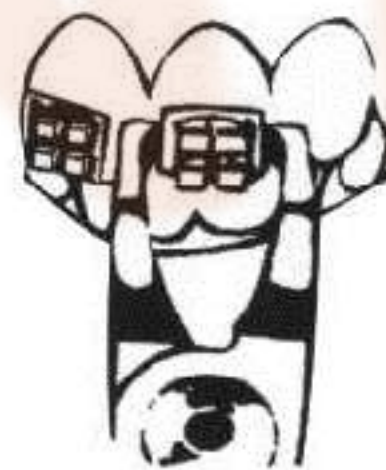

3230

Direct bond attachment remover (angled). For removing all bonded attachments. May be used mesial-distal-horizontal) or incisal-gingival (vertical) in anterior areas. Angled perfectly for easy access to difficult posterior areas.



Bird beack pliers



3231

Wire bending pliers. For wires up to 0,9 mm. (.036").

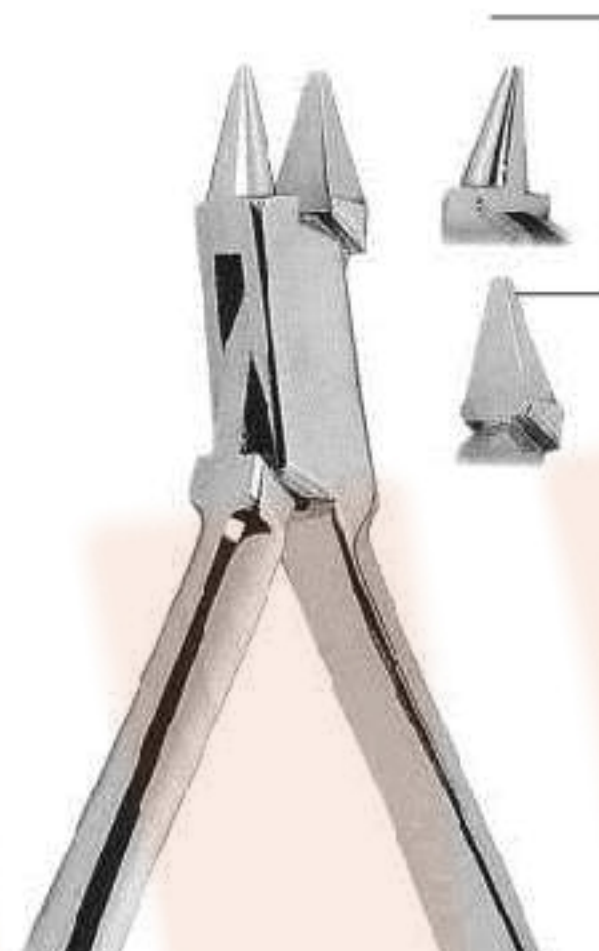

3232

Bird Beak Angle pliers for bending round, square or rectangular wire up to 0,7 mm. (.028").

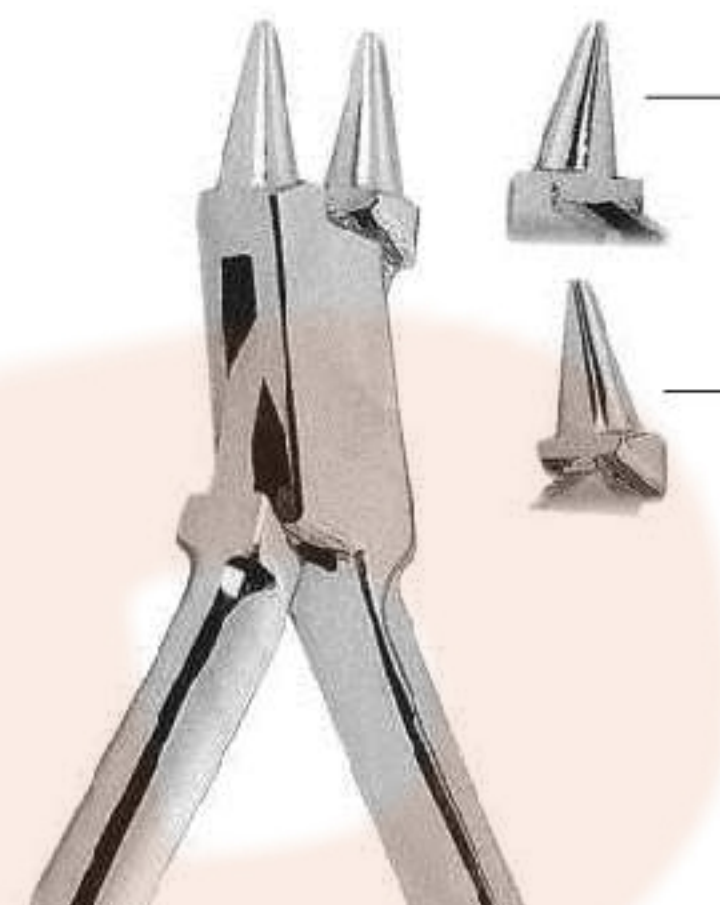

3233

Double rounded jaw wire bending pliers. For wires up to 0,7 mm. (.028").

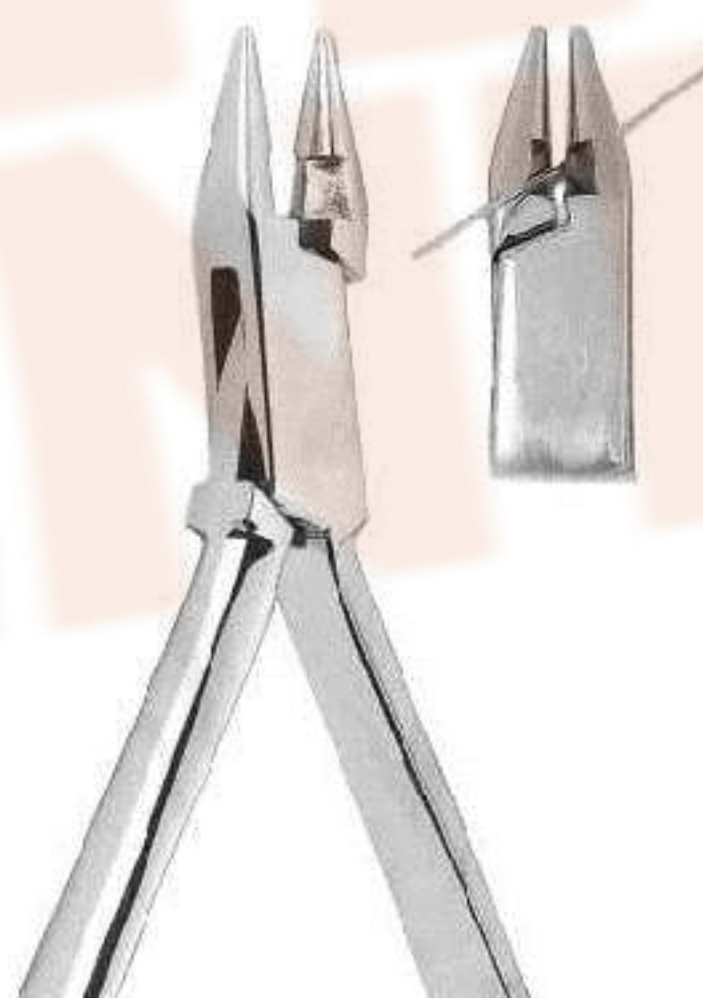

3234

Bird beak pliers for bending round, square or rectangular wire up to 0,7 mm. (.028"). With cutter.

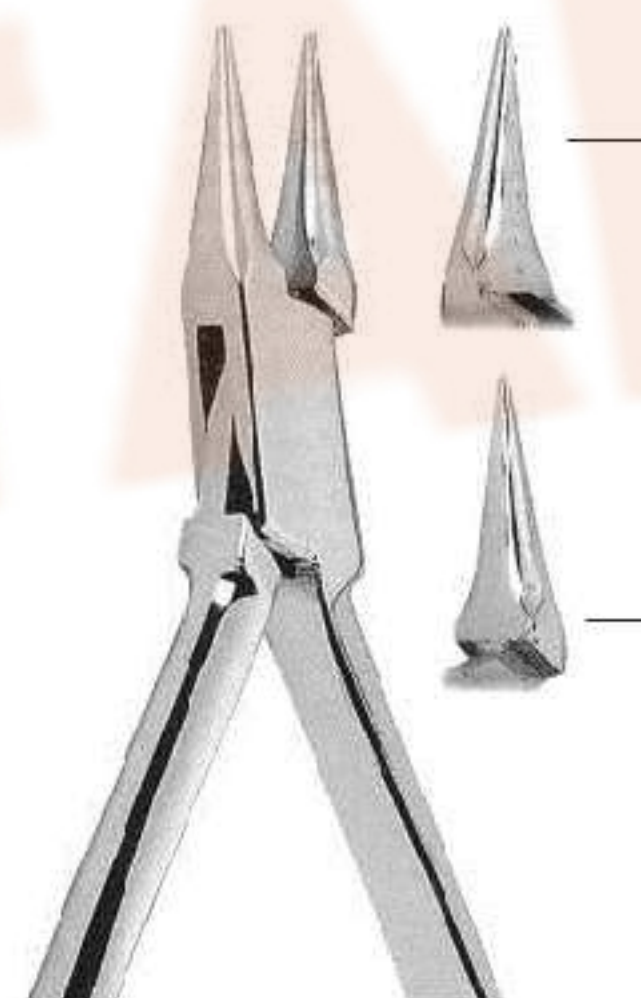

3235

Double rounded jaw wire bending pliers. For wires up to 0,7 mm. (.028").

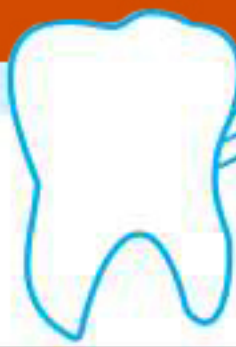

Pliers For Orthodontics and Prosthetics



3236
USA Model
125 mm



3237
Waldron
125 mm



3238
How
140 mm



3239
How
145 mm

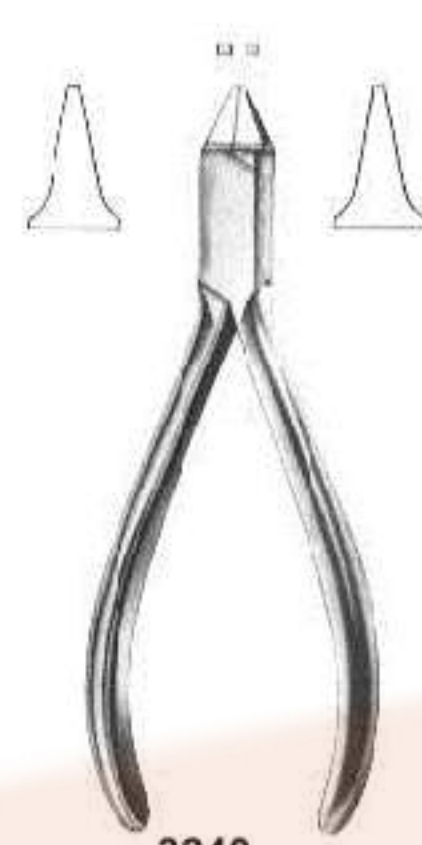

3240
Adams
125 mm



3241
Angle
125 mm



3242
young
130 mm

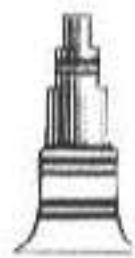

3243
Nance
130 mm



3244
Weingart
140 mm



3245
Johnson
130 mm



3246
Mc Kellops
155 mm



3247
Universal
150 mm



3248
Waldsachs
155 mm

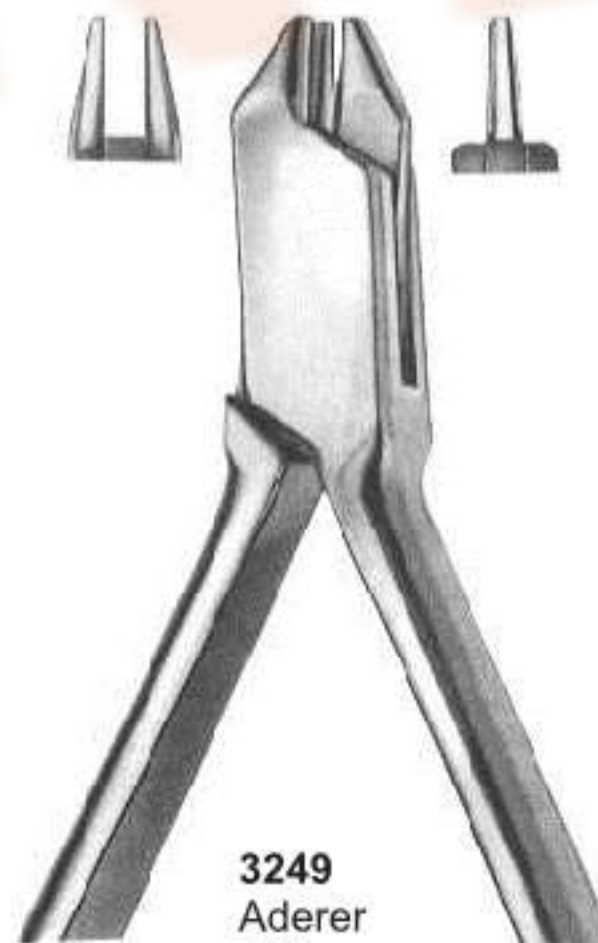

3249
Aderer
125 mm



3250
Nance
130 mm

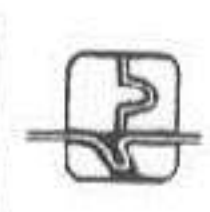



Pliers For Orthodontics and Prosthetics



3251
Langenbeck
140 mm



3252
Langenbeck
130 mm



3253
Langenbeck
130 mm



3254
Peeso
125 mm



3255
Goslee
125 mm

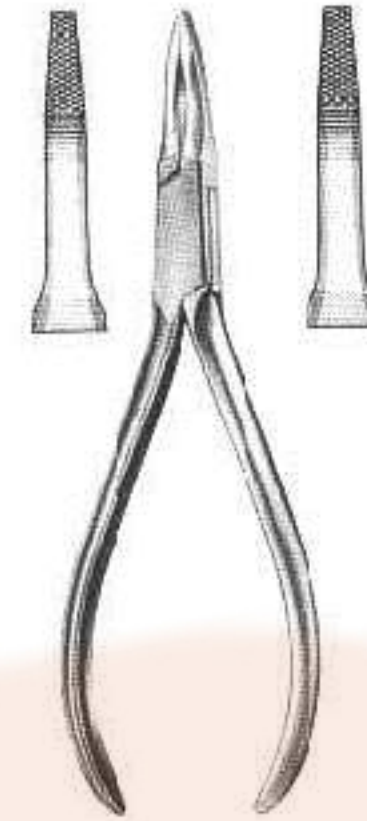

3256
Fischer
140 mm



3257
Andresen
130 mm

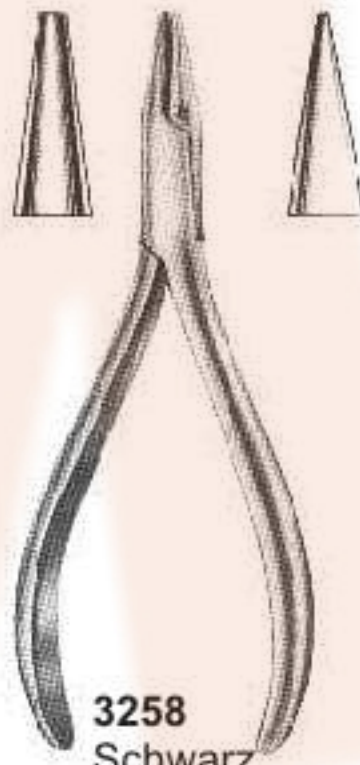

3258
Schwarz
130 mm

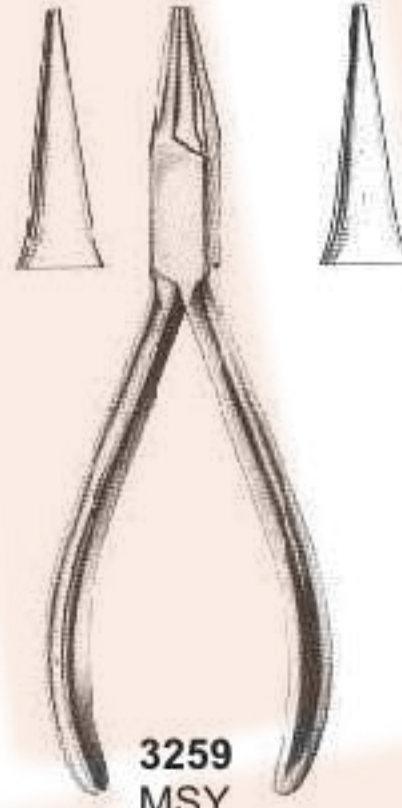

3259
MSY
130 mm

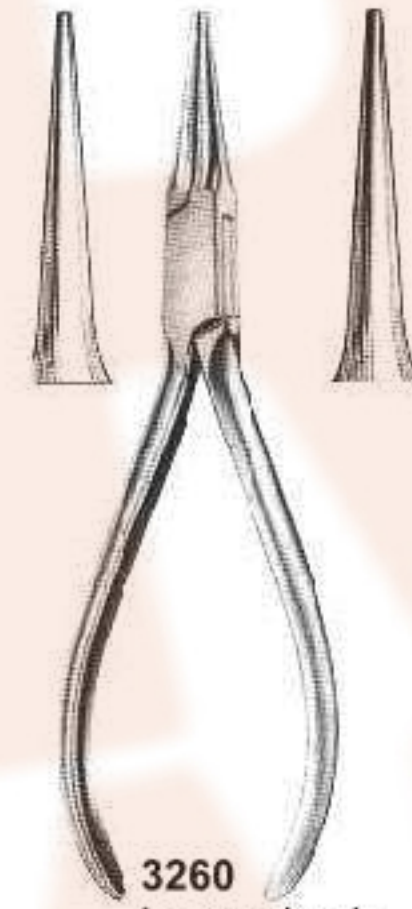

3260
Langenbeck
125 mm



3262



3263



3264



3265



3266



3267



3268



Pliers For Orthodontics and Prosthetics



3269



3270

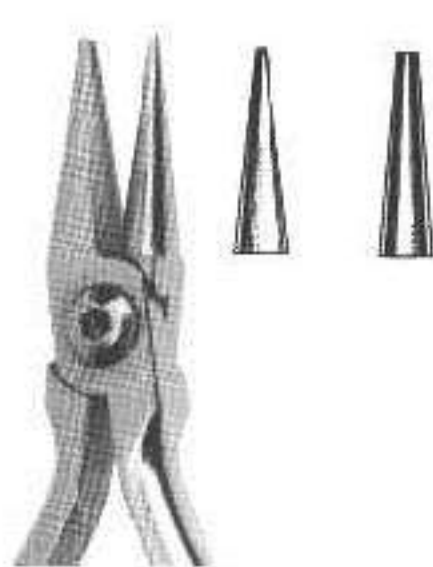

3271

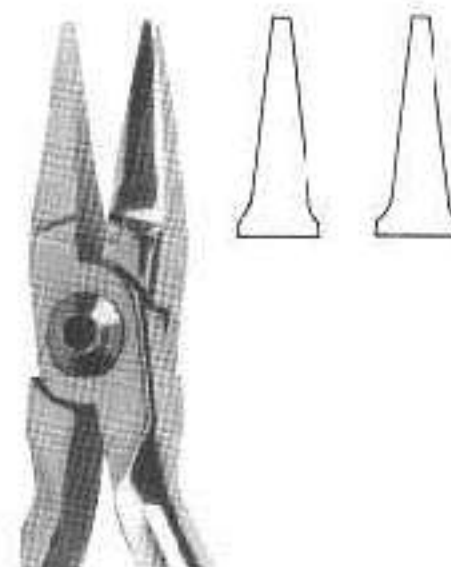

3272

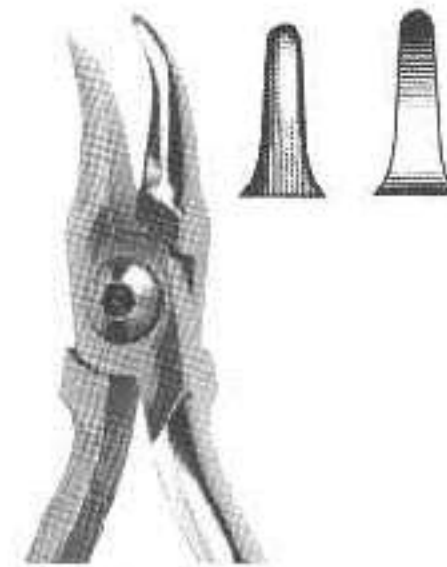

3273



3274



3275



3276



3277



3278



3279



3280



3281



3282

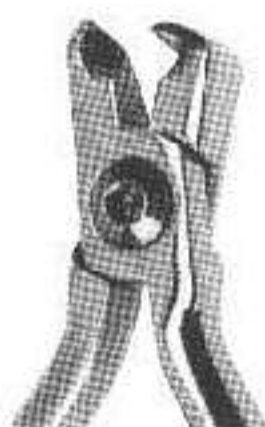

3283



3284



3285



3286



Stainless Steel Impression Trays

MIR
DENTAL

All Impression Trays Upper & Lower Type
are available in S, M, L & XL Sizes



3300
"HYDRO-LOCK"
stainless steel
water-cooled
impression trays
with retention rim.



3301
"HYDRO-LOCK"
stainless steel
water-cooled impression
trays with retention rim.



3302
"NEW SUPER"
stainless steel
impression trays
with retention rim.



3303
"NEW SUPER" stainless
steel impression trays
with retention rim.



3304
"ANATOMIC" solid
regular stainless
steel impression
trays without
retention rim.



3305
"ANATOMIC" solid regular
stainless steel impression
trays without retention rim.

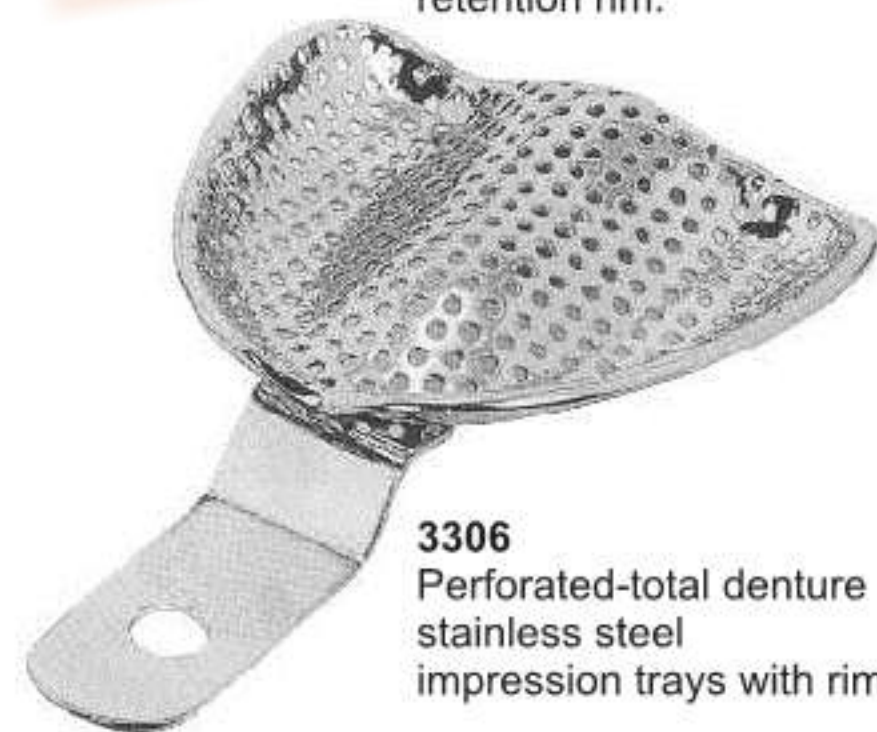

3306
Perforated-total denture
stainless steel
impression trays with rim.



3307
Perforated-total denture
stainless steel
impression trays with rim.



Stainless Steel Impression Trays

All Impression Trays Upper & Lower Type are available in S, M, L & XL Sizes



3308
"PERMA-LOCK" solid regular stainless steel impression trays with retention rim.



3309
"PERMA-LOCK" solid regular stainless steel impression trays with retention rim.



3310



3311



3312



3313



3314



3315

PACKINGS



3316
Set of six



3317
Set of Eight



3318
Solid stainless steel anterior depressed impression trays with retention rim.



3319



3320



3321



3322



3323



3324



3325
Solid stainless steel anterior depressed impression trays with retention rim.



Stainless Steel Impression Trays

MIR
DENTAL

All Impression Trays Upper & Lower Type
are available in S, M, L & XL Sizes

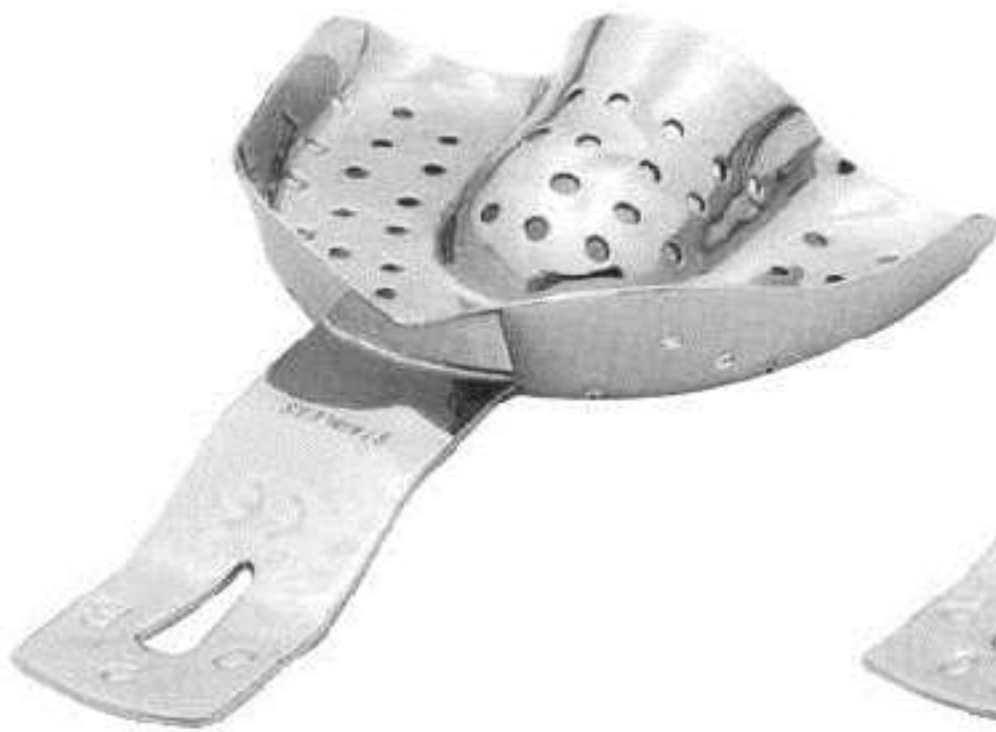

3326
Fig. 0 per bambini - for children

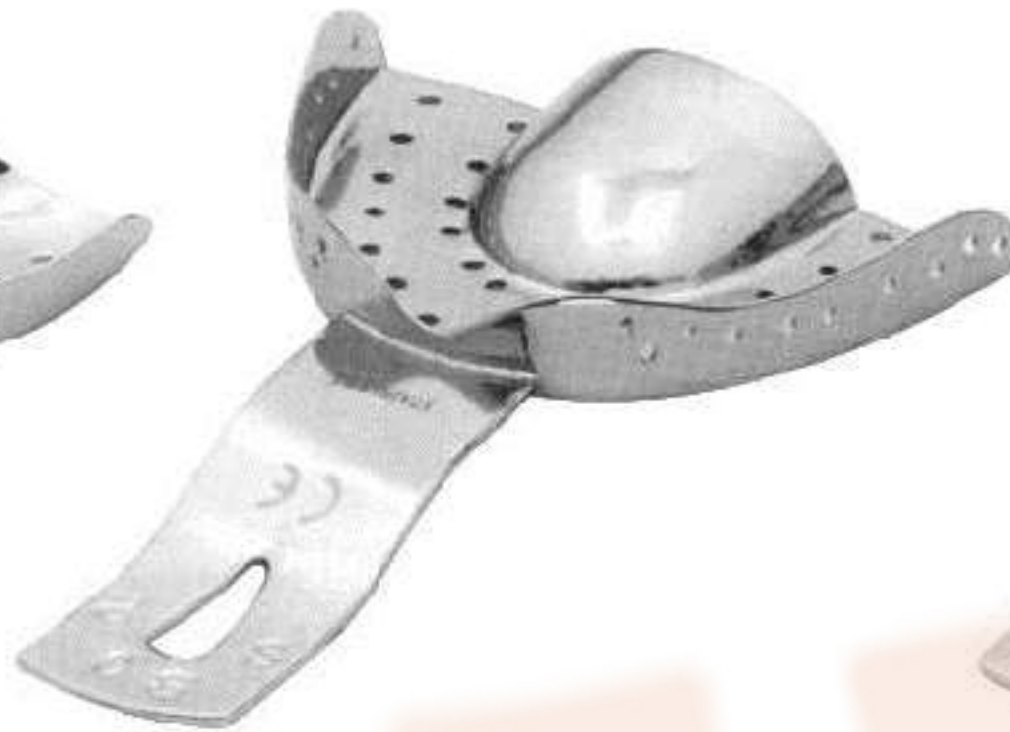

3327
For narrow toothed upper jaws



3328
Fig. 0 per bambini - for children

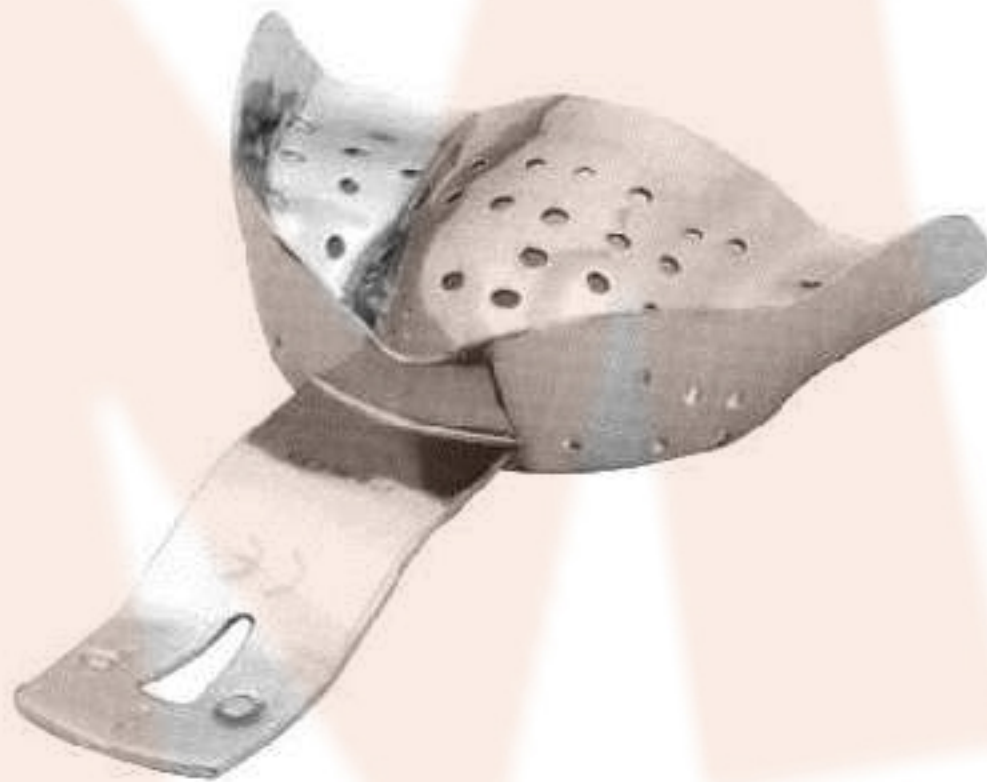

3329
For partially toothed upper jaws



3330
For partially toothed lower jaws



3331
For edentulous upper jaws



3332
For edentulous lower jaws



Stainless Steel Impression Trays

All Impression Trays Upper & Lower Type are available in S, M, L & XL Sizes



3333
Solid total denture stainless steel impression tray with rim.



3334
Solid total denture stainless steel impression tray with rim.



3335
"PERMA-LOCK" perforated regular stainless steel impression trays with retention rim.



3336
"PERMA-LOCK" perforated regular stainless steel impression trays with retention rim.

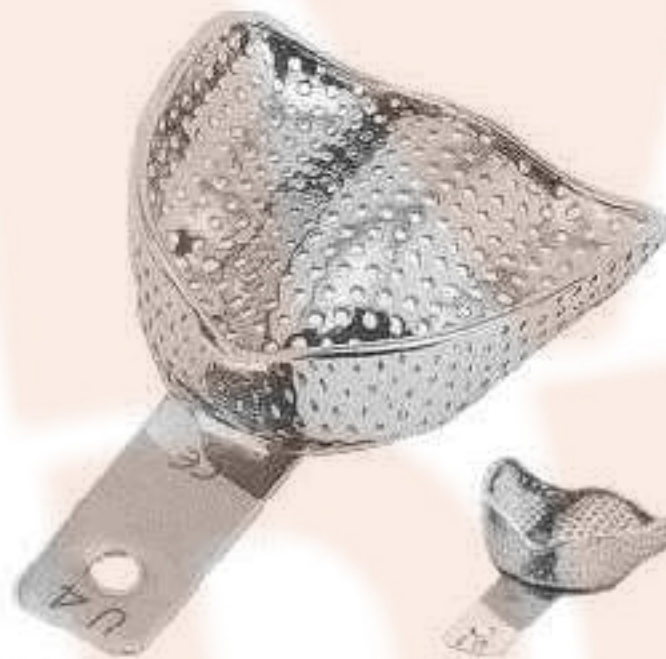

3337
Perforated stainless steel anterior depressed impression trays with retention rim.



3338



3339



3340



3341



3342



3343



3344
Perforated stainless steel anterior depressed impression trays with retention rim.



3345
Perforated stainless steel impression trays without retention rim for complete denture.



3346
Perforated stainless steel impression trays without retention rim for complete denture.



Articulators

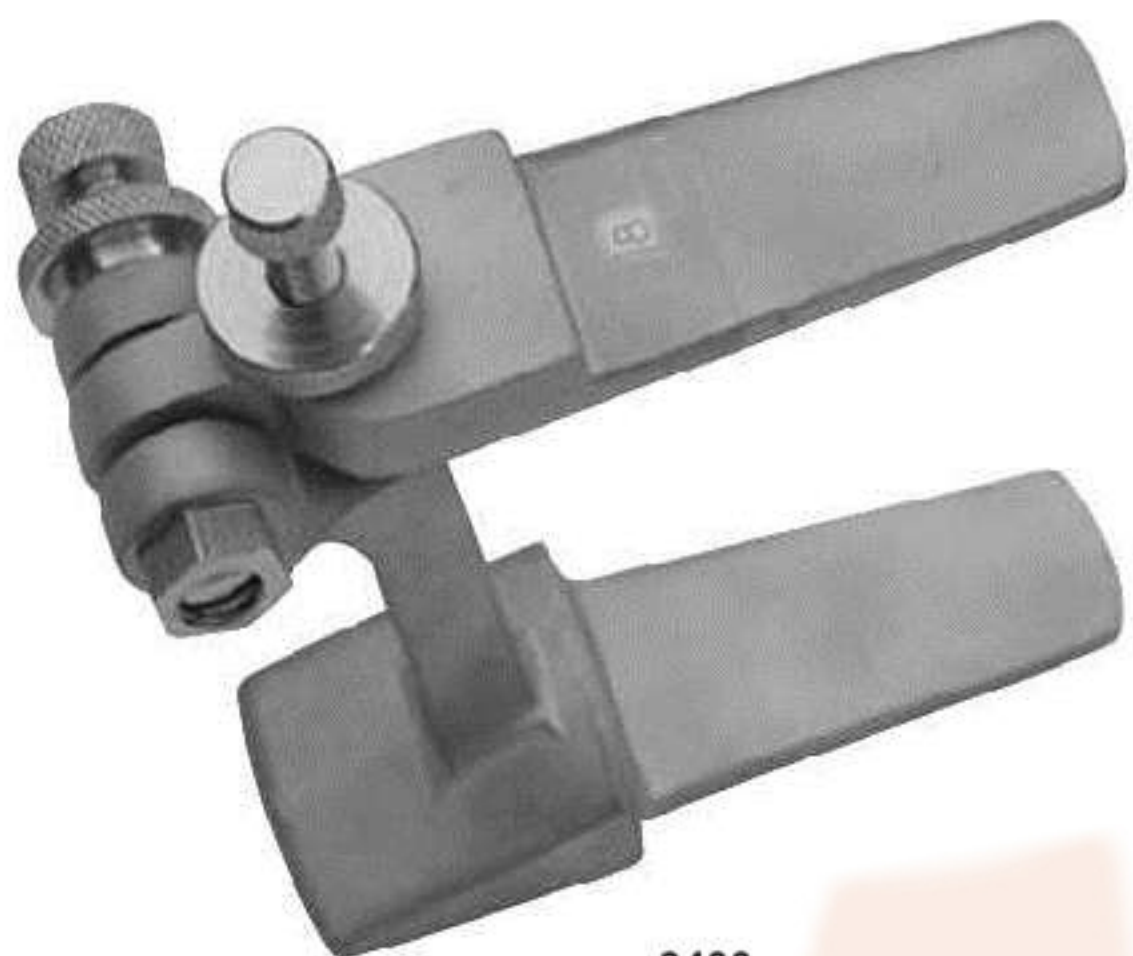

3400



3401



3402



3403

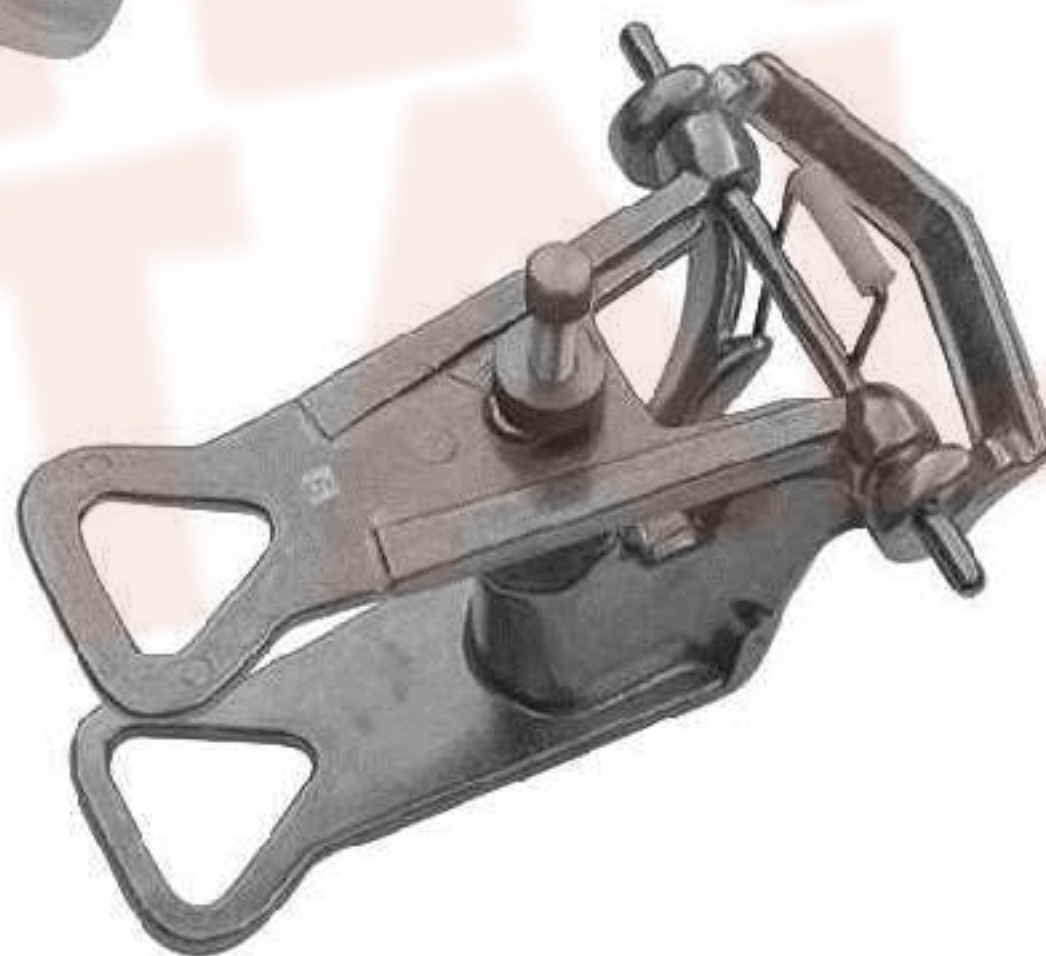

3404



3405



Articulators

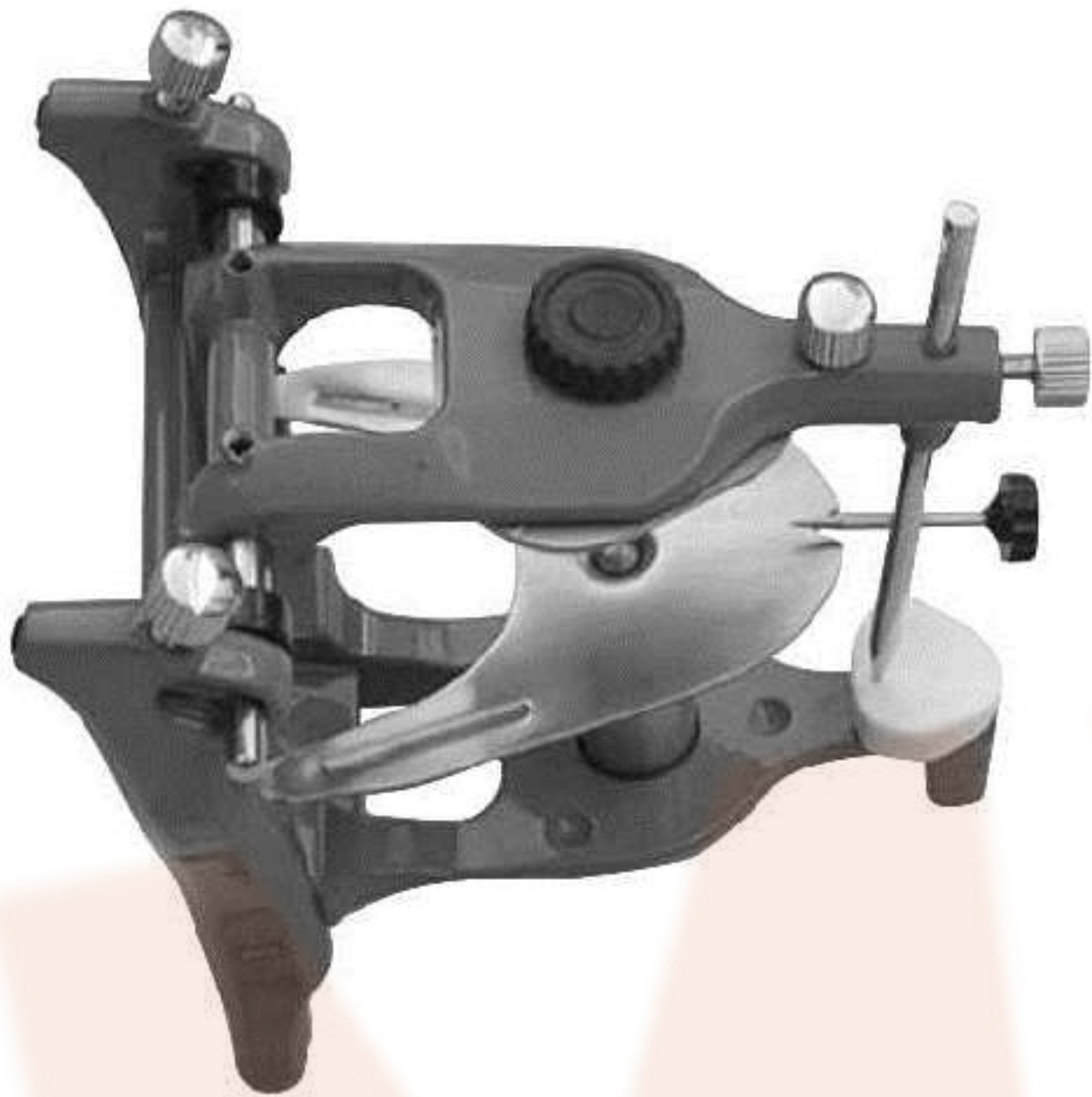

3406

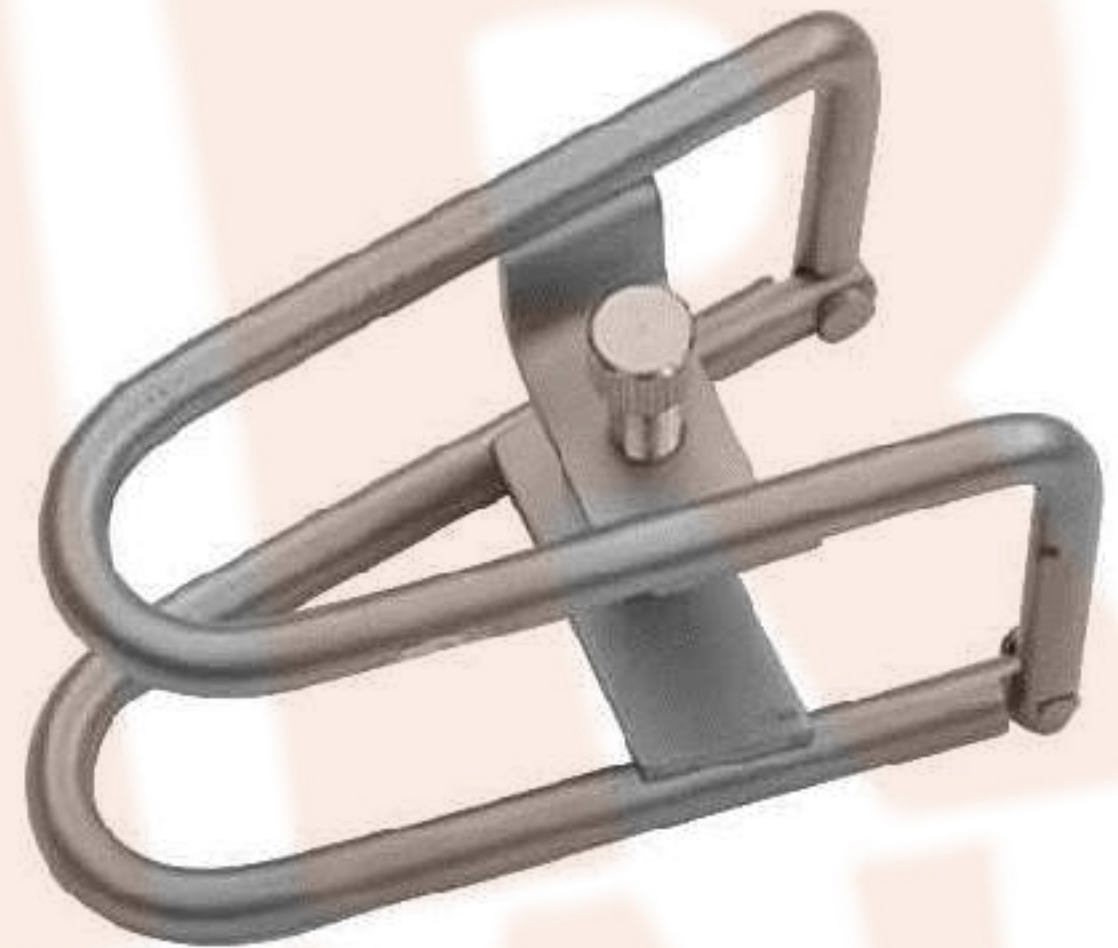

3407

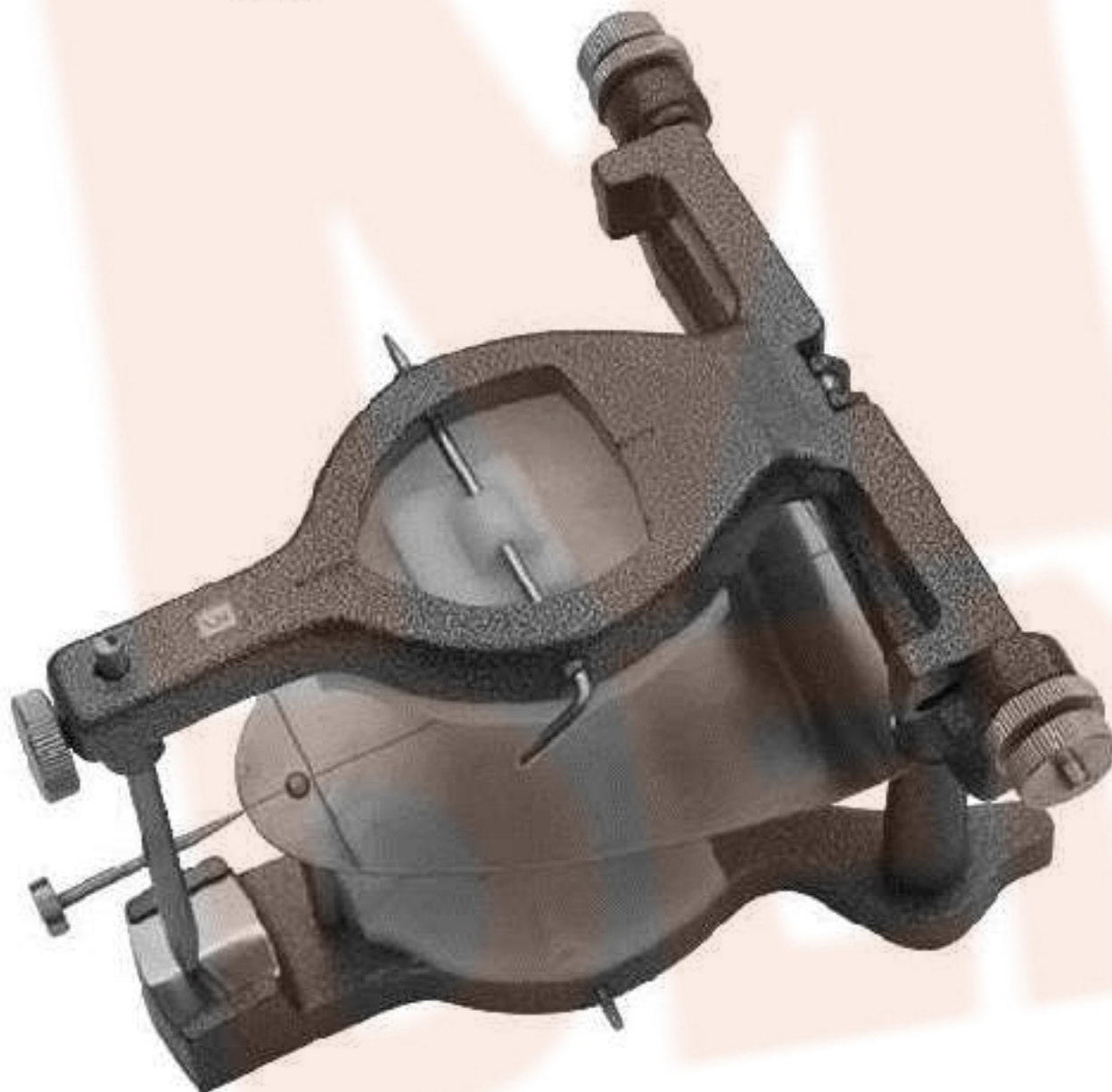

3408

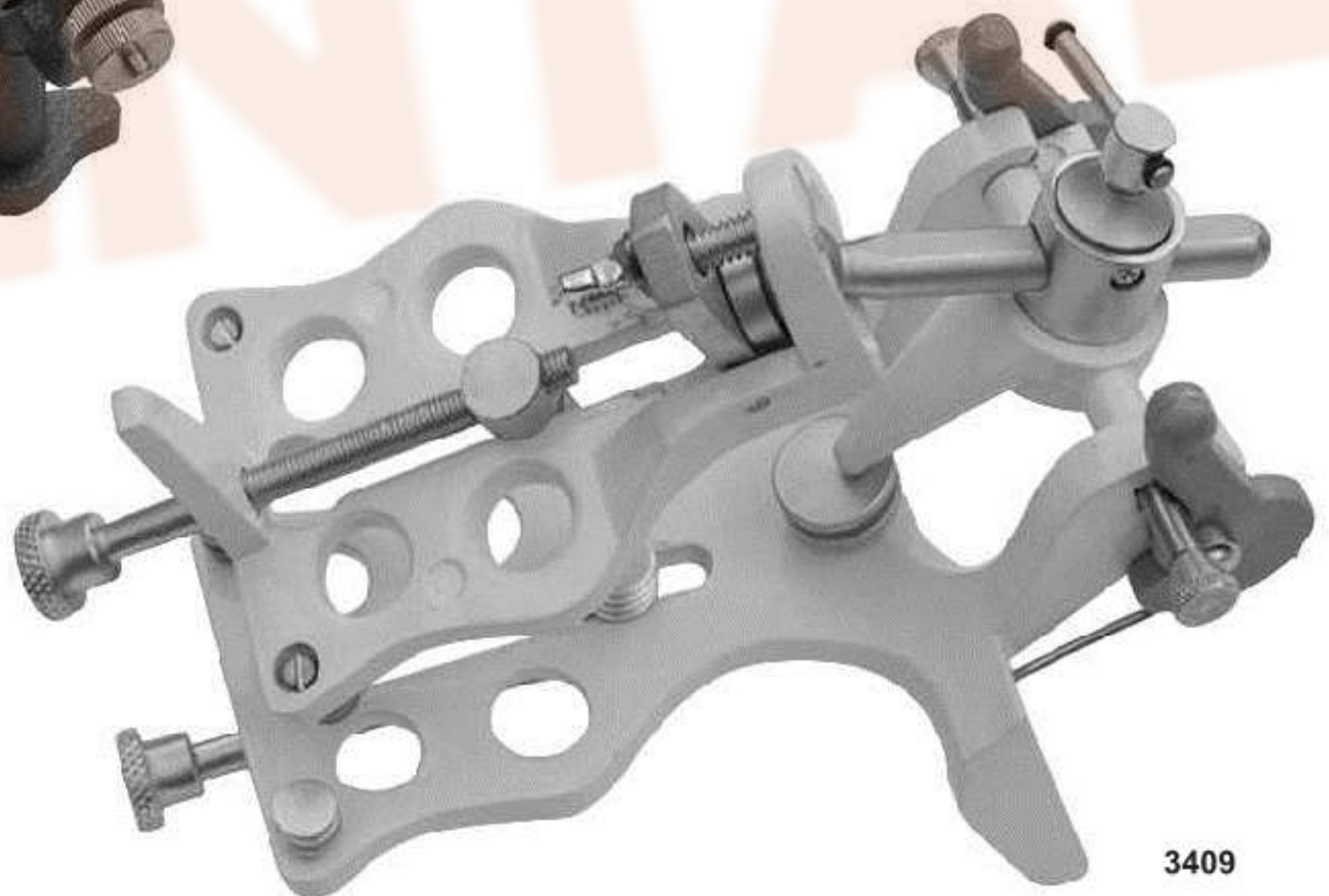

3409

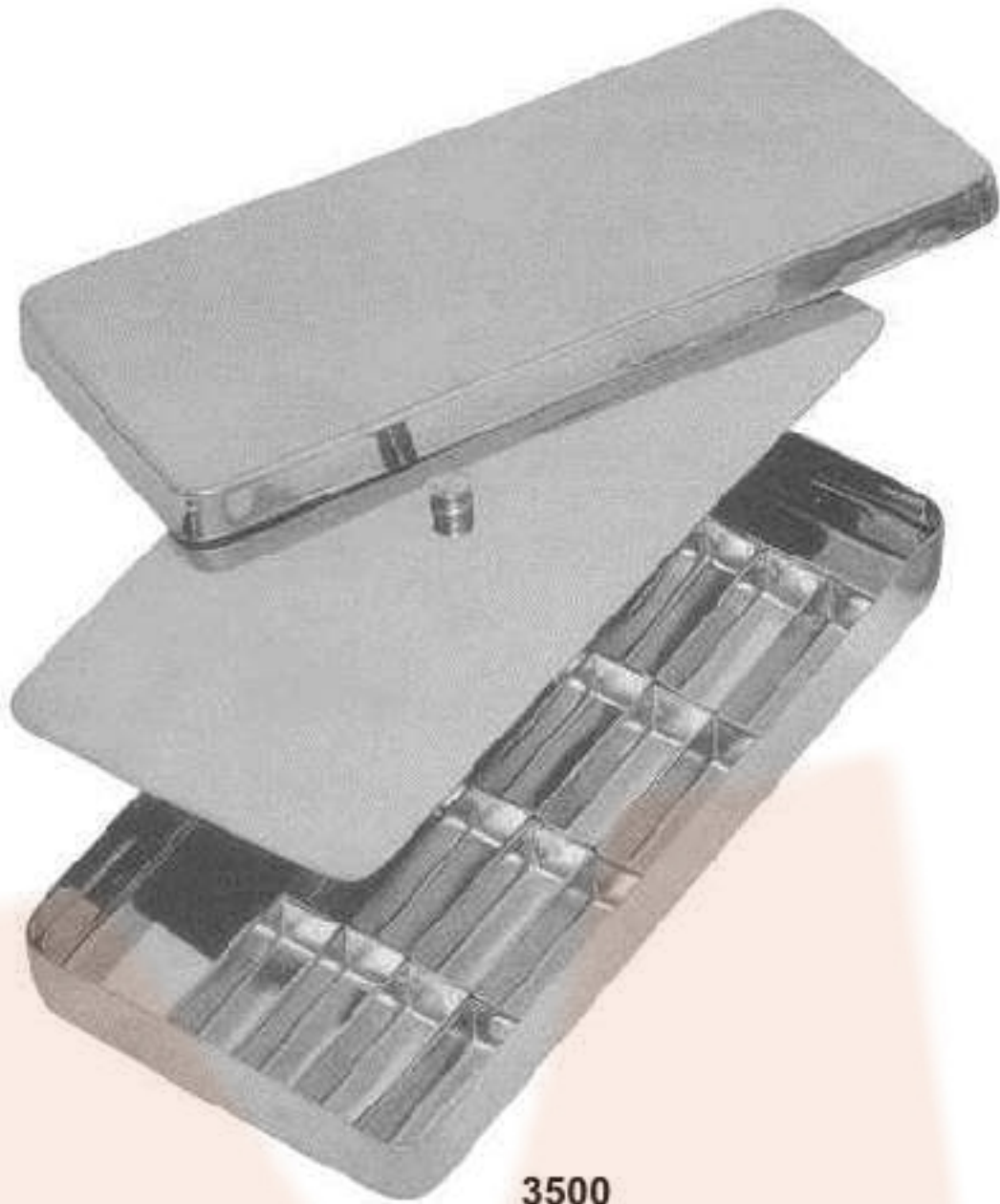

3500
ENDODONTIC BOX



3501
STERILIZING BOX
Available in dif. sizes
17x17x3 cm
20x10x4 cm
25x12x6 cm
30x14x6 cm



3502
ENDO TRAY BOX



3503
COTTON DISPENSER



3504
ALCOHOL LAMP

Sterilizing Drums



3505



3506



3507



Sterlizing Boxes



3508



3509



3510

Sterlizing Boxes



3511



3512



3513



3514



3515



3516

FORCEP AND THERMOMETER JARS

COTTON DISPENSER



3517
IRRIGATOR(Douch can)



3518
MEASURING JUG



3519
KIDNEY TRAY



Dental & Surgical Hollowares



3520
FORCEP JAR



3521
GALLIPOT WITH & WITHOUT LID



3522
SPITTEN MUG



3523
SPIRIT LAMP



3524
Perforated Tray

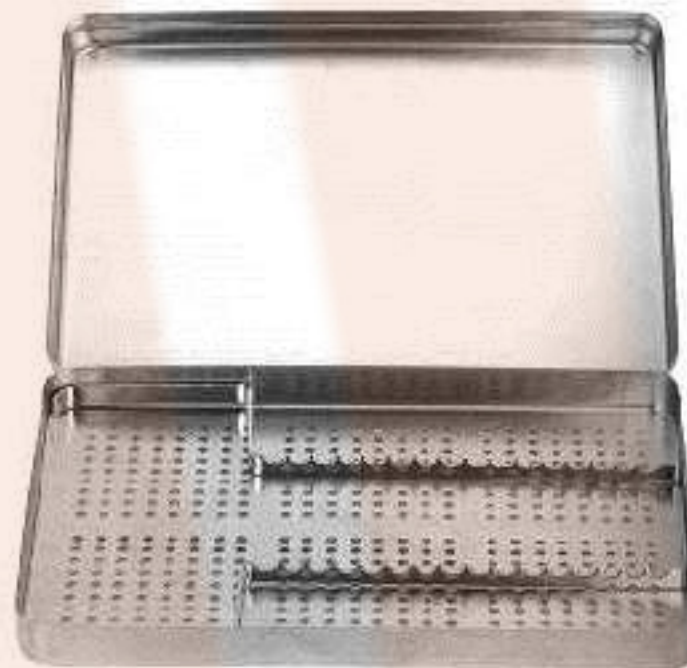

3525
Perforated Base



3526
Solid Base



3527
Instruments Tray



3528
Instruments Tray



3529
Instruments Tray
(Perforated)



3530
Instruments Tray Shallow
(Mayo)



3531
Scalers Tray



3532
Cathetar Tray



Dental & Surgical Hollowares



3520
FORCEP JAR



3521
GALLIPOT WITH & WITHOUT LID



3522
SPITTEN MUG



3523
SPIRIT LAMP



3524
Perforated Tray

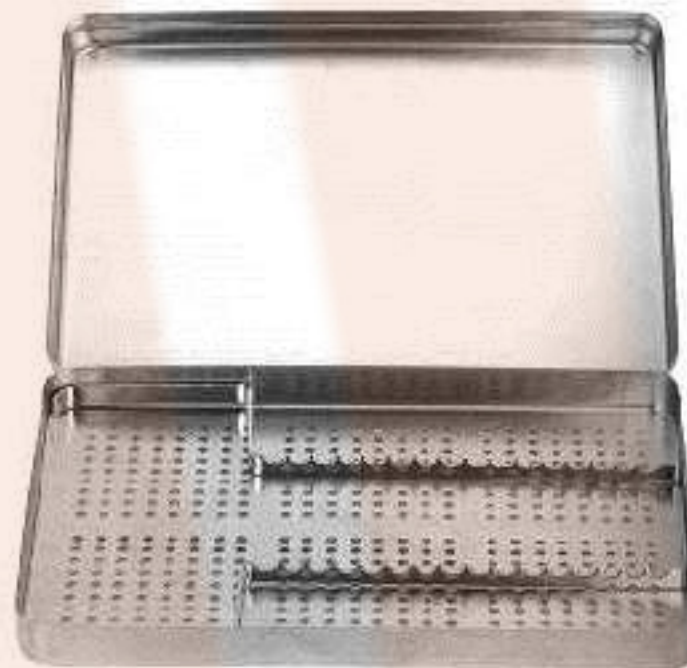

3525
Perforated Base



3526
Solid Base



3527
Instruments Tray



3528
Instruments Tray



3529
Instruments Tray
(Perforated)



3530
Instruments Tray Shallow
(Mayo)



3531
Scalers Tray



3532
Cathetar Tray